



# SIGNAGE CATALOG - V25

Standoff  
Systems

Caps and  
Barrels

Screw Cap  
Covers

Panel  
Mounts

Projecting  
Systems

Suspended  
Systems

Cable / Rod  
Systems

Art Hanging  
Systems

# Index Page

Navigate through our product selection with ease! Choose the title pages to find the product you need, and each SKU will take you directly to its product page.



<b>Standoff Systems.....</b>	<b>4</b>
Stainless Steel Standoffs . . . . .	6
201 Grade Stainless Steel Standoffs . . . . .	8
304 Grade Stainless Steel Standoffs . . . . .	10
316 Grade Stainless Steel Standoffs . . . . .	12
Stainless Steel Magnetic Standoffs . . . . .	14
Stainless Steel Tamper Proof Special Standoffs . . . . .	16
Stainless Steel Tamper Proof Square Standoffs . . . . .	18
Tamper Proof Flat Head Standoffs . . . . .	19
Stainless Steel Hollow Standoffs . . . . .	20
Aluminum Standoffs . . . . .	22
Sign Setter . . . . .	27
Aluminum Tamper Proof Standoffs . . . . .	28
Aluminum Color Standoffs . . . . .	32
Acrylic Wall Frame Kits . . . . .	40
Wooden Standoffs . . . . .	44
Brass Standoffs . . . . .	46
Acrylic Tamper Proof Standoffs . . . . .	47
Aluminum LED Standoffs . . . . .	48
Desktop Standoffs . . . . .	50
Cylinder & Conical Desktop Standoffs . . . . .	52
Cylinder & Conical Desktop Standoffs Kits . . . . .	53
Conical Edge Grip Desktop Standoffs . . . . .	54
Material Connectors . . . . .	55
Aluminum Talk Thru Standoffs . . . . .	56
Stainless Steel Talk Thru Edge Grip Standoffs . . . . .	57
Stainless Steel Panel Mount Standoffs . . . . .	58
Signage Glass . . . . .	59
Aluminum Non-Adjustable Sign Clamps . . . . .	60
Aluminum Adjustable Sign Clamps . . . . .	61
Aluminum LED Sign Clamps . . . . .	62
Aluminum Rectangular Edge Grip Standoffs . . . . .	63
Adjustable Edge Grip Standoffs . . . . .	64
Non-Adjustable Edge Grip Standoffs . . . . .	66
Stainless Steel Glass Standoffs . . . . .	68
Stainless Steel Glass Spigot Standoffs . . . . .	70
Mall Front Clamps . . . . .	71
Hardware for Standoffs . . . . .	74
Installation Tools for Standoffs . . . . .	75
<b>Standoff Caps &amp; Barrel Systems.....</b>	<b>77</b>
Caps and Barrels . . . . .	78
Flat Caps . . . . .	80
Tamper Proof Caps . . . . .	80
Round Caps . . . . .	80
Hex Caps . . . . .	82
Barrels . . . . .	84
Aluminum Square Caps and Barrels . . . . .	94
Aluminum Hub for Customizable Standoffs . . . . .	95
Hardware for Customizable Standoffs . . . . .	96
Machine Screws, Flat / Pan Head . . . . .	99
Tools for Customizable Standoffs . . . . .	100

<b>Screw Cap Covers.....</b>	<b>103</b>
Aluminum Screw Cap Covers . . . . .	104
Stainless Steel & Brass Screw Cap Covers . . . . .	105
Tapcon Screw Cap Covers . . . . .	106
Stainless Steel Tamper Proof Screws . . . . .	107
Screw Cover Caps . . . . .	108
Snap Caps for Screw . . . . .	109
Aluminum Panel Clip . . . . .	110

<b>Panel Mount Systems.....</b>	<b>113</b>
Z-Clip Panel Mounts . . . . .	114
Z-Clip Panel Mount Kits . . . . .	118
Acrylic French Cleat Kits . . . . .	120
Flush Hangers . . . . .	122
Quick Snap Standoffs . . . . .	124
Quick Snap Expander Standoffs . . . . .	128
Studs Full Threaded . . . . .	129
Button-Fix . . . . .	130
Button-Fix Sets with Tools . . . . .	134
Spacers . . . . .	136

<b>Projecting Systems.....</b>	<b>139</b>
Projecting Grippers . . . . .	140
Projecting Gripper Kits . . . . .	144
Wall Mounted Side Support . . . . .	146
Glass Wall Clamping Link . . . . .	148
Set of 2 Wall Clamp . . . . .	149
Flag Sign Kit . . . . .	150
Flag Sign Brackets . . . . .	151
Flag Sign Brackets . . . . .	152
Material Connectors . . . . .	153
Projecting Rod Systems 3/8" Diameter . . . . .	154
Aluminum T-Sign Brackets . . . . .	156
Aluminum U-Sign Brackets . . . . .	158
Double L Standing Sign Base . . . . .	159



































<b>Suspended Systems.....</b>	<b>161</b>
Self-Gripping Ceiling Mounted Aluminum Suspended System . . . . .	164
Suspended Double Cable Kits . . . . .	166
Suspended Single Cable Kit . . . . .	167
Drop Ceiling Suspended System Kits . . . . .	169
Top Mount Wire Suspension Kits for Signage . . . . .	170
Wire Suspension Kits for Signage . . . . .	171
Ceiling Mount Suspended System Kits with Forks . . . . .	172
Ceiling Mount Suspended System Kits with Hooks . . . . .	173
Suspended System Parts . . . . .	175
Suspended Rod Kits . . . . .	178
Rod Banner Hanger . . . . .	180
Hooks for Stainless Steel and Nylon Cable . . . . .	181
Sign Hangers for Panels & Brackets . . . . .	182

<b>Cable / Rod Systems.....</b>	<b>185</b>
Signature Cable Systems . . . . .	186
1/16" - 1/8" Diameter Mounted Cable Kits . . . . .	186
Sign Hangers for Panels & Brackets . . . . .	188
1/16" Cable Diameter Multi Angle Cable Kits . . . . .	188
1/16" Cable Diameter / Ceiling to Wall Mounted Kits . . . . .	190
1/16" Cable Diameter / Wall to Wall Mounted Kits . . . . .	191
1/8" Cable Diameter / Multi Angle Kits . . . . .	192
1/4" Rod Ceiling To Floor Mounted Kits . . . . .	193
1/4" Rod Ceiling to Wall / Wall to Floor Mounted Kits . . . . .	194
1/4" Rod Wall to Wall Mounted Kits . . . . .	195
3/8" Rod Ceiling to Floor / Wall to Ceiling Mounted Kits . . . . .	196
3/8" Rod to Wall Mounted Kits . . . . .	197
Panel Grips Diameter Cable Kits . . . . .	198
Panel Grips For Cable & Rod . . . . .	200
Shelf Supports . . . . .	202
Acrylic Sign Holders . . . . .	204
Row by Row Attached Cable System . . . . .	206
Row Attached Cable System . . . . .	207
LED Poster Holder . . . . .	208
1/4" Rod Sign Holder . . . . .	210
1/4" Rod Accessories . . . . .	212
Aluminum Track and Accessories . . . . .	213

<b>Art Hanging Systems.....</b>	<b>215</b>
Hanging Systems . . . . .	216
Easy Rail . . . . .	218
Classic Rail . . . . .	222
Ceiling Rail . . . . .	226
Hanging Cables . . . . .	230
Hooks for Stainless Steel and Nylon Cable . . . . .	231
Aircraft Wire Cable Stop Clamp Adjuster Gripper Loopers . . . . .	233
Hooks For Stainless Steel and Nylon Cable . . . . .	234
Aluminum Snap Frames . . . . .	236
Hanging Banner Rails . . . . .	237



# Standoff Systems

<b>NEW</b> Products Added		Stainless Steel Standoffs	8	<b>NEW</b> Products Added		Aluminum Tamper Proof Standoffs	30		Cylinder & Conical Desktop Standoffs Kits	55		Aluminum Rectangular Edge Grip Standoffs	65		
<b>NEW</b> Products Added		Stainless Steel Magnetic Standoffs	16	<b>NEW</b> Products Added		Aluminum Color Standoffs	34	<b>NEW</b> Products Added		Conical Edge Grip Desktop Standoffs	56		Adjustable Edge Grip Standoffs	66	
		Stainless Steel Special Standoffs	18	<b>NEW</b> Products Added		Acrylic Wall Frame Kits	42			Material Connectors	57		Non-Adjustable Edge Grip Standoffs	68	
		Glass Standoff with Material Marker	19			Wooden Standoffs	46	<b>NEW</b> Products Added		Aluminum Talk Thru Standoffs	58	<b>NEW</b> Products Added		Stainless Steel Glass Standoffs	70
		Stainless Steel Square Standoffs	20			Brass Standoffs	48	<b>NEW</b> Products Added		Talk Thru Edge Grip Standoffs	59			Stainless Steel Glass Spigot Standoffs	72
		Tamper Proof Standoffs Flat Head Standoffs	21	<b>NEW</b> Products Added		Acrylic Tamper Proof Standoffs	49	<b>NEW</b> Products Added		Stainless Steel Panel Mount Standoffs	60	<b>NEW</b> Products Added		Mall Front Clamps	73
<b>NEW</b> Products Added		Stainless Steel Hollow Standoffs	22			LED Standoffs	50			Aluminum Sign Clamps	62			Hardware for Standoffs	76
<b>NEW</b> Products Added		Aluminum Standoffs	24			Desktop Standoffs	52	<b>NEW</b> Products Added		Aluminum Adjustable Sign Clamps	63			Installation Tools for Standoffs	77
		Sign Setter	29			Cylinder & Conical Desktop Standoffs	54	<b>NEW</b> Products Added		Aluminum LED Sign Clamps	64				



## Stainless Steel Standoffs



# Stainless Steel Standoffs

10% Cheaper Than Equivalent Aluminum Products

3 Material Grades, Satin Brushed & Polished Available!



## 201 Grade

Stainless Steel Standoffs for Indoor use

Commonly used in indoor applications where moderate corrosion resistance, strength, and formability are needed, while also offering a cost-effective solution.

### Area of Use

Indoor Homes, Offices, Malls, Schools, Airports



Stainless Steel Satin Brushed

Stainless Steel Polished

Replacement Heads

Extended Heads

## Stainless Steel Standoffs



## 304 Grade

Stainless Steel Tamper Proof Standoffs for Indoor & Outdoor Use

Widely used in both indoor and outdoor applications that require high corrosion resistance, strength, and formability, while also providing a cost-effective solution.

### Area of Use

Indoor and Outdoor Homes, Offices, Malls, Schools, Airports



Stainless Steel Satin Brushed

Stainless Steel Polished

Extended Heads



## 316 Grade

Stainless Steel Tamper Proof Standoffs for Indoor & Outdoor Use

Commonly used in both indoor and outdoor applications that demand the highest levels of corrosion resistance, strength, and formability, offering extended durability.

### Area of Use

Yachts, Cruises, Waterfront Hotels and Buildings



Stainless Steel Satin Brushed

Stainless Steel Polished



## 201 Grade Stainless Steel Standoffs

- Product**
  - Heads
  - Washers
  - Barrels
  - Screws and Anchors
  - Instruction Guide
- Unique Features**
  - Indoor Use Only
  - Wall Mounted
  - 6 Different Diameters
  - 5 Different Heights
- Area Of Use**
  - Signage
  - Wayfinder
  - Display
  - Advertising
- Additional Details**
  - Hardware included only for kits



## 201 Grade Stainless Steel Standoffs

### Indoor Use only

- **Units** do not include hardware.
- **Kits** come with 4 standoffs, mounting hardware and instruction guide.
- **Head Replacements** include 2 nylon washers.

Standoff Head Diameter	Material Thickness Accepted	Standoff Barrel Height	Material Hole Diameter	Satin Brushed			Polished		
				Satin Brushed (SBLS)	Satin Brushed (SBLS)	Satin Brushed Head Replacements (SBLS)	Polished (SBLP)	Polished Kits (SBLP)	Polished Head Replacements (SBLP)
A	B	C	D	Sold As Unit	Sold As Kit		Sold As Unit	Sold As Kit	

1/2"	0 to 1/4"	1/2"	3/8"	SBLS12-12	SBLS12-12-KIT	SBLS12-12-HEAD	SBLP12-12	SBLP12-12-KIT	SBLP12-12-HEAD
	0 to 1/2"	3/4"		SBLS12-25	SBLS12-25-KIT		SBLP12-25	SBLP12-25-KIT	
	0 to 1/2"	1"		SBLS12-30	SBLS12-30-KIT	SBLS12-HEAD	SBLP12-30	SBLP12-30-KIT	SBLP12-HEAD
	0 to 1/2"	1-3/4"		SBLS12-50	SBLS12-50-KIT		SBLP12-50	SBLP12-50-KIT	
	0 to 1/2"	2-1/2"		SBLS12-70	SBLS12-70-KIT	SBLP12-70	SBLP12-70-KIT		
5/8"	0 to 1/4"	1/2"	7/16"	SBLS16-12	SBLS16-12-KIT	SBLS16-12-HEAD	SBLP16-12	SBLP16-12-KIT	SBLP16-12-HEAD
	0 to 1/2"	3/4"		SBLS16-25	SBLS16-25-KIT		SBLP16-25	SBLP16-25-KIT	
	0 to 1/2"	1"		SBLS16-30	SBLS16-30-KIT	SBLS16-HEAD	SBLP16-30	SBLP16-30-KIT	SBLP16-HEAD
	0 to 1/2"	1-3/4"		SBLS16-50	SBLS16-50-KIT		SBLP16-50	SBLP16-50-KIT	
	0 to 1/2"	2-1/2"		SBLS16-70	SBLS16-70-KIT	SBLP16-70	SBLP16-70-KIT		
3/4"	0 to 1/4"	1/2"	7/16"	SBLS19-12	SBLS19-12-KIT	SBLS19-12-HEAD	SBLP19-12	SBLP19-12-KIT	SBLP19-12-HEAD
	0 to 1/2"	3/4"		SBLS19-25	SBLS19-25-KIT		SBLP19-25	SBLP19-25-KIT	
	0 to 1/2"	1"		SBLS19-30	SBLS19-30-KIT	SBLS19-HEAD	SBLP19-30	SBLP19-30-KIT	SBLP19-HEAD
	0 to 1/2"	1-3/4"		SBLS19-50	SBLS19-50-KIT		SBLP19-50	SBLP19-50-KIT	
	0 to 1/2"	2-1/2"		SBLS19-70	SBLS19-70-KIT	SBLP19-70	SBLP19-70-KIT		
7/8"	3/4" to 1"	Extended Head		S19SSS			S19SSP		
	0 to 1/4"	1/2"	7/16"	SBLS22-12	SBLS22-12-KIT	SBLS22-12-HEAD	SBLP22-12	SBLP22-12-KIT	SBLP22-12-HEAD
	0 to 1/2"	3/4"		SBLS22-25	SBLS22-25-KIT		SBLP22-25	SBLP22-25-KIT	
	0 to 1/2"	1"		SBLS22-30	SBLS22-30-KIT	SBLS22-HEAD	SBLP22-30	SBLP22-30-KIT	SBLP22-HEAD
	0 to 1/2"	1-3/4"		SBLS22-50	SBLS22-50-KIT		SBLP22-50	SBLP22-50-KIT	
0 to 1/2"	2-1/2"	SBLS22-70		SBLS22-70-KIT	SBLP22-70	SBLP22-70-KIT			
1"	3/4" to 1"	Extended Head		S22SSS			S22SSP		
	0 to 1/4"	1/2"	7/16"	SBLS25-12	SBLS25-12-KIT	SBLS25-12-HEAD	SBLP25-12	SBLP25-12-KIT	SBLP25-12-HEAD
	0 to 1/2"	3/4"		SBLS25-25	SBLS25-25-KIT		SBLP25-25	SBLP25-25-KIT	
	0 to 1/2"	1"		SBLS25-30	SBLS25-30-KIT	SBLS25-HEAD	SBLP25-30	SBLP25-30-KIT	SBLP25-HEAD
	0 to 1/2"	1-3/4"		SBLS25-50	SBLS25-50-KIT		SBLP25-50	SBLP25-50-KIT	
0 to 1/2"	2-1/2"	SBLS25-70		SBLS25-70-KIT	SBLP25-70	SBLP25-70-KIT			
1-1/4"	3/4" to 1"	Extended Head		S25SSS			S25SSP		
	0 to 1/4"	1/2"	7/16"	SBLS30-12	SBLS30-12-KIT	SBLS30-12-HEAD	SBLP30-12	SBLP30-12-KIT	SBLP30-12-HEAD
	0 to 1/2"	3/4"		SBLS30-25	SBLS30-25-KIT		SBLP30-25	SBLP30-25-KIT	
	0 to 1/2"	1"		SBLS30-30	SBLS30-30-KIT	SBLS30-HEAD	SBLP30-30	SBLP30-30-KIT	SBLP30-HEAD
	0 to 1/2"	1-3/4"		SBLS30-50	SBLS30-50-KIT		SBLP30-50	SBLP30-50-KIT	
0 to 1/2"	2-1/2"	SBLS30-70		SBLS30-70-KIT	SBLP30-70	SBLP30-70-KIT			
3/4" to 1"	Extended Head			S30SSS*			S30SSP*		

1/2" & 5/8" Diameter: Use for drywall: screw 2208 and anchor ANC5, ANC5Z. Use for concrete: screw 2208 and anchor ANC1  
 3/4" to 1-1/4" Diameter: Use for drywall: screw 2216 and anchor ANC6, ANC6Z. Use for concrete: screw 2216 and anchor ANC2

### Standoff Selection Guide

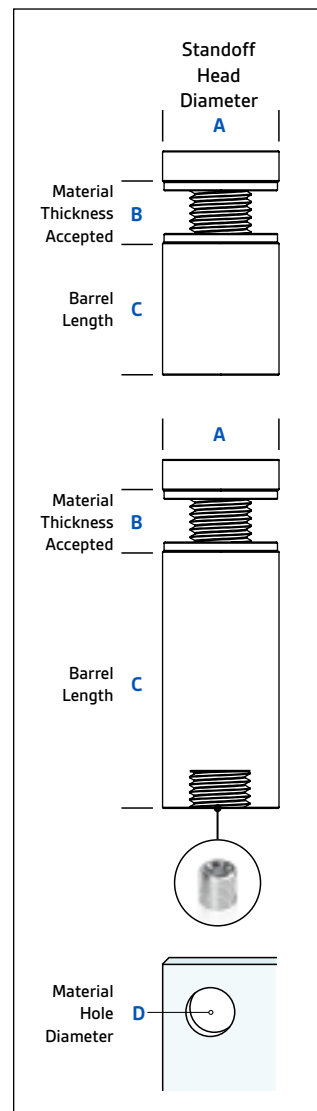

**NEW**

**All In One Kits!**  
 4 x Standoffs  
 4 x Screws  
 4 x Anchors  
 1 x Installation Guide

\* Minimum order quantity is 100, available upon request.

**Thick Material?**  
 Extended Head Allows for 3/4" to 1"



Available in 3/4", 7/8", 1", 1-1/4" Diameters  
 Metric: M10x150

## 304 Grade Stainless Steel Standoffs

- Product**
  - Heads
  - Washers
  - Barrels
  - Allen Key
  - Screws and Anchors
  - Instruction Guide
- Unique Features**
  - Indoor & Outdoor Use
  - Tamper Proof
  - Wall Mounted
  - 6 Different Diameters
  - 5 Different Heights
- Area Of Use**
  - Signage
  - Wayfinder
  - Display
  - Advertising
- Additional Details**
  - Hardware included only for kits



### Standoff Selection Guide

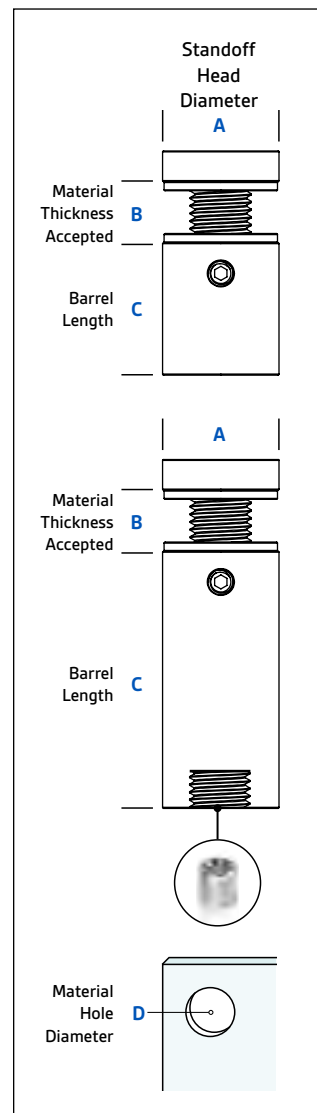

**NEW**

- All In One Kits!**
- 4 x Standoffs
  - 4 x Screws
  - 4 x Anchors
  - 1 x Allen Key
  - 1 x Installation Guide

\* Minimum order quantity is 100, available upon request.

**Thick Material?**  
Extended Head Allows for 3/4" to 1"

Available in 3/4", 7/8", 1", 1-1/4" Diameters  
Metric: M10x150



## 304 Grade Stainless Steel Standoffs

### Indoor and Outdoor Use

- **Units** do not include hardware.
- **Kits** come with 4 standoffs, mounting hardware, allen key and instruction guide.

Satin Brushed

Polished



Standoff Head Diameter	Material Thickness Accepted	Standoff Barrel Height	Material Hole Diameter	Satin Brushed (LBS)	Satin Brushed Kits (LBS)	Polished (LBP)	Polished Kits (LBP)
A	B	C	D	Sold As Unit	Sold As Kit	Sold As Unit	Sold As Kit
1/2"	0 to 1/4"	1/2"	3/8"	LBS12-12	LBS12-12-KIT	LBP12-12	LBP12-12-KIT
	0 to 1/2"	3/4"		LBS12-25	LBS12-25-KIT	LBP12-25	LBP12-25-KIT
	0 to 1/2"	1"		LBS12-30	LBS12-30-KIT	LBP12-30	LBP12-30-KIT
	0 to 1/2"	1-3/4"		LBS12-50	LBS12-50-KIT	LBP12-50	LBP12-50-KIT
5/8"	0 to 1/2"	2-1/2"	7/16"	LBS12-70	LBS12-70-KIT	LBP12-70	LBP12-70-KIT
	0 to 1/4"	1/2"		LBS16-12	LBS16-12-KIT	LBP16-12	LBP16-12-KIT
	0 to 1/2"	3/4"		LBS16-25	LBS16-25-KIT	LBP16-25	LBP16-25-KIT
	0 to 1/2"	1"		LBS16-30	LBS16-30-KIT	LBP16-30	LBP16-30-KIT
3/4"	0 to 1/2"	1-3/4"	7/16"	LBS16-50	LBS16-50-KIT	LBP16-50	LBP16-50-KIT
	0 to 1/2"	2-1/2"		LBS16-70	LBS16-70-KIT	LBP16-70	LBP16-70-KIT
	0 to 1/4"	1/2"		LBS19-12	LBS19-12-KIT	LBP19-12	LBP19-12-KIT
	0 to 1/2"	3/4"		LBS19-25	LBS19-25-KIT	LBP19-25	LBP19-25-KIT
7/8"	0 to 1/2"	1"	7/16"	LBS19-30	LBS19-30-KIT	LBP19-30	LBP19-30-KIT
	0 to 1/2"	1-3/4"		LBS19-50	LBS19-50-KIT	LBP19-50	LBP19-50-KIT
	0 to 1/2"	2-1/2"		LBS19-70	LBS19-70-KIT	LBP19-70	LBP19-70-KIT
	3/4" to 1"	Extended Head		<i>i</i> S19SS304	<i>i</i> S19SP304*		
1"	0 to 1/4"	1/2"	7/16"	LBS22-12	LBS22-12-KIT	LBP22-12	LBP22-12-KIT
	0 to 1/2"	3/4"		LBS22-25	LBS22-25-KIT	LBP22-25	LBP22-25-KIT
	0 to 1/2"	1"		LBS22-30	LBS22-30-KIT	LBP22-30	LBP22-30-KIT
	0 to 1/2"	1-3/4"		LBS22-50	LBS22-50-KIT	LBP22-50	LBP22-50-KIT
1-1/4"	0 to 1/2"	2-1/2"	7/16"	LBS22-70	LBS22-70-KIT	LBP22-70	LBP22-70-KIT
	3/4" to 1"	Extended Head		<i>i</i> S22SS304	<i>i</i> S22SP304*		
	0 to 1/4"	1/2"		LBS25-12	LBS25-12-KIT	LBP25-12	LBP25-12-KIT
	0 to 1/2"	3/4"		LBS25-25	LBS25-25-KIT	LBP25-25	LBP25-25-KIT
1-1/4"	0 to 1/2"	1"	7/16"	LBS25-30	LBS25-30-KIT	LBP25-30	LBP25-30-KIT
	0 to 1/2"	1-3/4"		LBS25-50	LBS25-50-KIT	LBP25-50	LBP25-50-KIT
	0 to 1/2"	2-1/2"		LBS25-70	LBS25-70-KIT	LBP25-70	LBP25-70-KIT
	3/4" to 1"	Extended Head		<i>i</i> S25SS304	<i>i</i> S25SP304*		
1-1/4"	0 to 1/4"	1/2"	7/16"	LBS30-12	LBS30-12-KIT	LBP30-12	LBP30-12-KIT
	0 to 1/2"	3/4"		LBS30-25	LBS30-25-KIT	LBP30-25	LBP30-25-KIT
	0 to 1/2"	1"		LBS30-30	LBS30-30-KIT	LBP30-30	LBP30-30-KIT
	0 to 1/2"	1-3/4"		LBS30-50	LBS30-50-KIT	LBP30-50	LBP30-50-KIT
1-1/4"	0 to 1/2"	2-1/2"	7/16"	LBS30-70	LBS30-70-KIT	LBP30-70	LBP30-70-KIT
	3/4" to 1"	Extended Head		<i>i</i> S30SS304*	<i>i</i> S30SP304*		

1/2" & 5/8" Diameter: Use for drywall: screw 2208 and anchor ANC5, ANC5Z. Use for concrete: screw 2208 and anchor ANC1  
3/4" to 1-1/4" Diameter: Use for drywall: screw 2216 and anchor ANC6, ANC6Z. Use for concrete: screw 2216 and anchor ANC2



## 316 Grade Stainless Steel Standoffs

- Product**
  - Head
  - Washers
  - Barrels
  - Allen Key
  - Screws and Anchors
  - Instruction Guide
- Unique Features**
  - Indoor & Outdoor Use
  - Tamper Proof
  - Wall Mounted
  - 6 Different Diameters
  - 5 Different Heights
- Area Of Use**
  - Signage
  - Wayfinder
  - Display
  - Advertising
- Additional Details**
  - Hardware included only for kits



**NEW**

### All In One Kits!

- 4 x Standoffs
- 4 x Screws
- 4 x Anchors
- 1 x Allen Key
- 1 x Installation Guide

\* Minimum order quantity is 100, available upon request.

**Thick Material?**  
Extended Head Allows for 3/4" to 1"



Available in 3/4", 7/8", 1", 1-1/4" Diameters  
Metric: M10x150

### Standoff Selection Guide

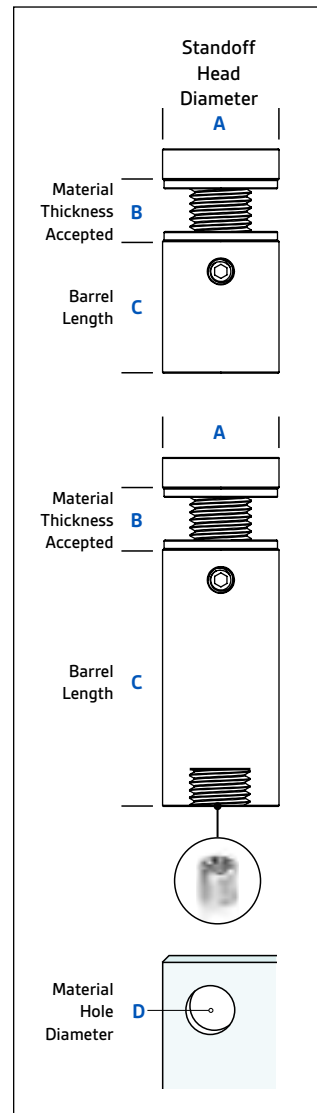

## 316 Grade Stainless Steel Standoffs

### Indoor and Outdoor Use

- Units do not include hardware.
- Kits come with 4 standoffs, mounting hardware, allen key and instruction guide.

#### Satin Brushed

#### Polished



Standoff Head Diameter A	Material Thickness Accepted B	Standoff Barrel Height C	Material Hole Diameter D	Satin Brushed (LBS)	Satin Brushed Kits (LBS)	Polished (LBP*)
				Sold As Unit	Sold As Kit	Sold As Unit
1/2"	0 to 1/4"	1/2"	3/8"	316LBS12-12	316LBS12-12-KIT	316LBP12-12*
	0 to 1/2"	3/4"		316LBS12-25	316LBS12-25-KIT	316LBP12-25*
	0 to 1/2"	1"		316LBS12-30	316LBS12-30-KIT	316LBP12-30*
	0 to 1/2"	1-3/4"		316LBS12-50	316LBS12-50-KIT	316LBP12-50*
	0 to 1/2"	2-1/2"		316LBS12-70	316LBS12-70-KIT	316LBP12-70*
5/8"	0 to 1/4"	1/2"	7/16"	316LBS16-12	316LBS16-12-KIT	316LBP16-12*
	0 to 1/2"	3/4"		316LBS16-25	316LBS16-25-KIT	316LBP16-25*
	0 to 1/2"	1"		316LBS16-30	316LBS16-30-KIT	316LBP16-30*
	0 to 1/2"	1-3/4"		316LBS16-50	316LBS16-50-KIT	316LBP16-50*
	0 to 1/2"	2-1/2"		316LBS16-70	316LBS16-70-KIT	316LBP16-70*
3/4"	0 to 1/4"	1/2"	7/16"	316LBS19-12	316LBS19-12-KIT	316LBP19-12*
	0 to 1/2"	3/4"		316LBS19-25	316LBS19-25-KIT	316LBP19-25*
	0 to 1/2"	1"		316LBS19-30	316LBS19-30-KIT	316LBP19-30*
	0 to 1/2"	1-3/4"		316LBS19-50	316LBS19-50-KIT	316LBP19-50*
	0 to 1/2"	2-1/2"		316LBS19-70	316LBS19-70-KIT	316LBP19-70*
	3/4" to 1"	Extended Head		316LBS19-70	316LBS19-70-KIT	316LBP19-70*
7/8"	0 to 1/4"	1/2"	7/16"	316LBS22-12	316LBS22-12-KIT	316LBP22-12*
	0 to 1/2"	3/4"		316LBS22-25	316LBS22-25-KIT	316LBP22-25*
	0 to 1/2"	1"		316LBS22-30	316LBS22-30-KIT	316LBP22-30*
	0 to 1/2"	1-3/4"		316LBS22-50	316LBS22-50-KIT	316LBP22-50*
	0 to 1/2"	2-1/2"		316LBS22-70	316LBS22-70-KIT	316LBP22-70*
	3/4" to 1"	Extended Head		316LBS22-70	316LBS22-70-KIT	316LBP22-70*
1"	0 to 1/4"	1/2"	7/16"	316LBS25-12	316LBS25-12-KIT	316LBP25-12*
	0 to 1/2"	3/4"		316LBS25-25	316LBS25-25-KIT	316LBP25-25*
	0 to 1/2"	1"		316LBS25-30	316LBS25-30-KIT	316LBP25-30*
	0 to 1/2"	1-3/4"		316LBS25-50	316LBS25-50-KIT	316LBP25-50*
	0 to 1/2"	2-1/2"		316LBS25-70	316LBS25-70-KIT	316LBP25-70*
	3/4" to 1"	Extended Head		316LBS25-70	316LBS25-70-KIT	316LBP25-70*
1-1/4"	0 to 1/4"	1/2"	7/16"	316LBS30-12	316LBS30-12-KIT	316LBP30-12*
	0 to 1/2"	3/4"		316LBS30-25	316LBS30-25-KIT	316LBP30-25*
	0 to 1/2"	1"		316LBS30-30	316LBS30-30-KIT	316LBP30-30*
	0 to 1/2"	1-3/4"		316LBS30-50	316LBS30-50-KIT	316LBP30-50*
	0 to 1/2"	2-1/2"		316LBS30-70	316LBS30-70-KIT	316LBP30-70*
	3/4" to 1"	Extended Head		316LBS30-70	316LBS30-70-KIT	316LBP30-70*
	3/4" to 1"	Extended Head		316LBS30-70	316LBS30-70-KIT	316LBP30-70*
	3/4" to 1"	Extended Head		316LBS30-70	316LBS30-70-KIT	316LBP30-70*
	3/4" to 1"	Extended Head		316LBS30-70	316LBS30-70-KIT	316LBP30-70*
	3/4" to 1"	Extended Head		316LBS30-70	316LBS30-70-KIT	316LBP30-70*

1/2" & 5/8" Diameter: Use for drywall: screw 2208 and anchor ANC5, ANC5Z. Use for concrete: screw 2208 and anchor ANC1  
 3/4" to 1-1/4" Diameter: Use for drywall: screw 2216 and anchor ANC6, ANC6Z. Use for concrete: screw 2216 and anchor ANC2



## Stainless Steel Magnetic Standoffs

**Product**  
Cap  
Washers  
Magnetic Barrel

**Unique Features**  
Indoor Use Only  
Wall Mounted  
Removable

**Area Of Use**  
Signage  
Wayfinder  
Display  
Advertising

**Additional Details**  
Strong Neodymium Magnets



## Stainless Steel Magnetic Standoffs

Our new magnetic standoffs are the perfect solution for signs and artwork to be easily removed, swapped or moved, with a magnet directly embedded within the stainless steel barrel, you may choose to use provided steel washers as your mounting solution or they can be used on any surface made of steel.

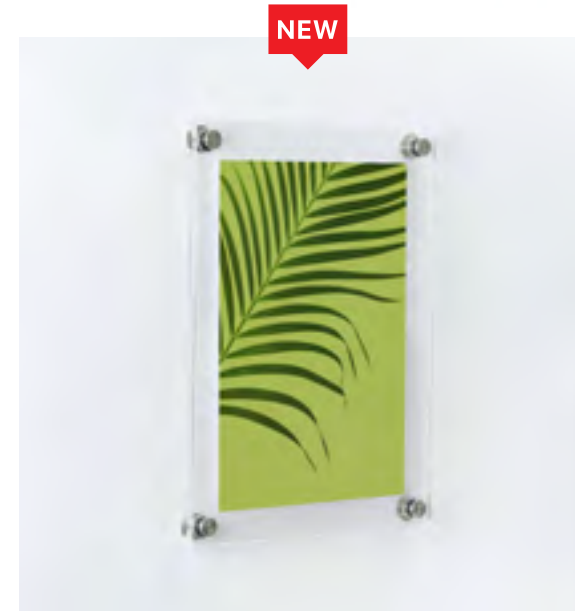

### Magnetic Standoffs Wall Frame Kits

- Includes:  
4 x Magnetic Standoffs  
4 x Stainless Steel Washers  
2 x 1/8" Acrylic Sheets  
4 x Screws and Anchors  
1 x Drill Template and Instruction Guide



Acrylic Width	Acrylic Height	Acrylic Thickness	Kit of 4 Magnetic Standoffs included
8-1/2"	11"	1/8" each	AMS85X11
10"	12-1/2"	1/8" each	AMS10X125

### Magnetic Standoffs Kit of 4

- Includes:  
4 x Magnetic Standoffs  
4 x Stainless Steel Washers  
4 x Screws and Anchors  
1 x Instruction Guide



Standoff Diameter	Material Thickness Accepted	Barrel Height	Hardware included (SS)
1/2"	5/16" to 3/8"	9/16"	MS075SS304

## Stainless Steel Tamper Proof Special Standoffs

- Product**
  - Head
  - Washers
  - Barrel
- Unique Features**
  - (201) Indoor Use Only
  - (304) Indoor & Outdoor
  - Wall Mounted
  - 2 Different Diameters
- Area Of Use**
  - Signage
  - Wayfinder
  - Display
  - Advertising
- Additional Details**
  - Non-threaded barrel
  - Tamper Proof

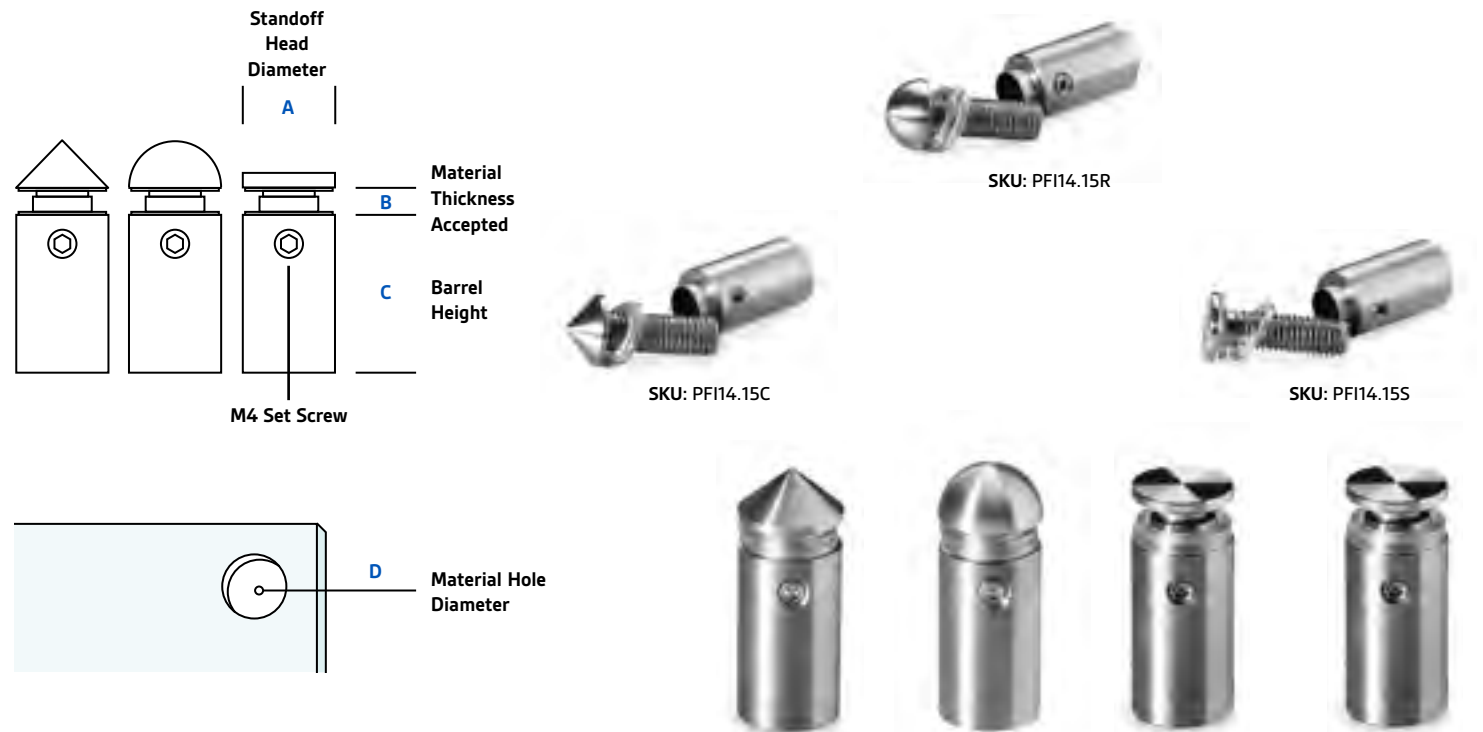
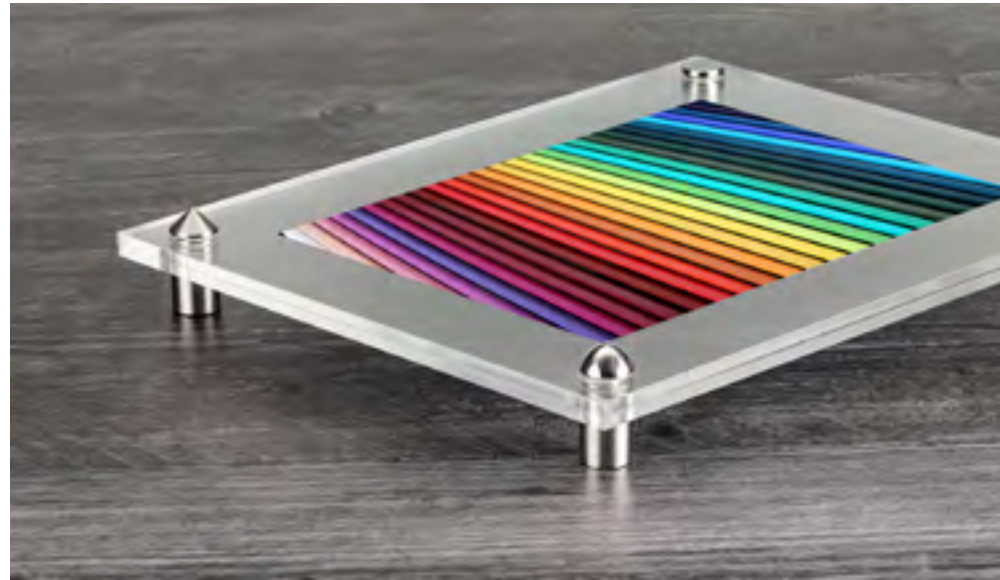

Standoff Head Diameter	Material Thickness Accepted	Standoff Barrel Height	Material Hole Diameter	Satin Brushed Conical Head (SS)	Satin Brushed Round Head (SS)	Satin Brushed Flat Head (SS)	Satin Brushed Flat Head 304 (SS)
A	B	C	D				
1/2"	1/8" to 1/4"	1/2"	3/8"	PFI14.15C	PFI14.15R	PFI14.15	PFI14.15S
1/2"	1/8" and 5/8"	1"	3/8"	PFI14.25C	PFI14.25R	PFI14.25	PFI14.25S

Use for drywall: screw 2208 and anchor ANC5, ANC5Z. Use for concrete: screw 2208 and anchor ANC1  
 \* Non-threaded barrel. \* Mounting hardware not included.

## Glass Standoffs with Material Connector

- Product**
  - Head
  - Washers
  - Barrel
- Unique Features**
  - (201) Indoor Use Only
  - (304) Indoor & Outdoor
  - Wall Mounted
  - 2 Different Diameters
- Area Of Use**
  - Signage
  - Wayfinder
  - Display
  - Advertising
- Additional Details**
  - Non-threaded barrel
  - Tamper Proof

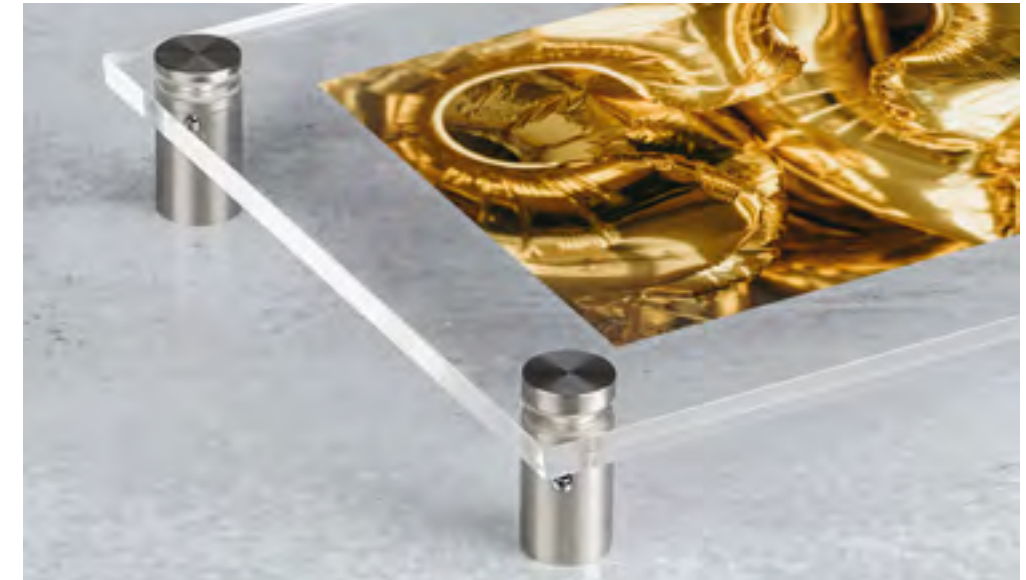

Standoff Head Diameter	Material Thickness Accepted	Standoff Barrel Height	Material Hole Diameter	Satin Brushed Standard Head (SS)	Satin Brushed Flat Head (SS)	Satin Brushed Flat Head 304 (SS)
A	B	C	D			
3/4"	1/8" and 5/8"	1"	3/8"	PFI19.25ST	PFI19.25FL	PFI19.25SST
1"	1/8" and 5/8"	1"	3/8"	PFI25.25ST	PFI25.25FL	PFI25.25SST

Use for drywall: screw 2216 and anchor ANC6, ANC6Z. Use for concrete: screw 2216 and anchor ANC2  
 \* Non-threaded Barrel. \* Mounting hardware not included.



## Stainless Steel Tamper Proof Square Standoffs

<b>Product</b>	Head Washers Barrel
<b>Unique Features</b>	201 Indoor Use only 304 Indoor & Outdoor Use Wall Mounted 3 Different Heights 3 Different Widths
<b>Area Of Use</b>	Signage Wayfinder Display Advertising
<b>Additional Details</b>	Non-threaded barrel Tamper Proof

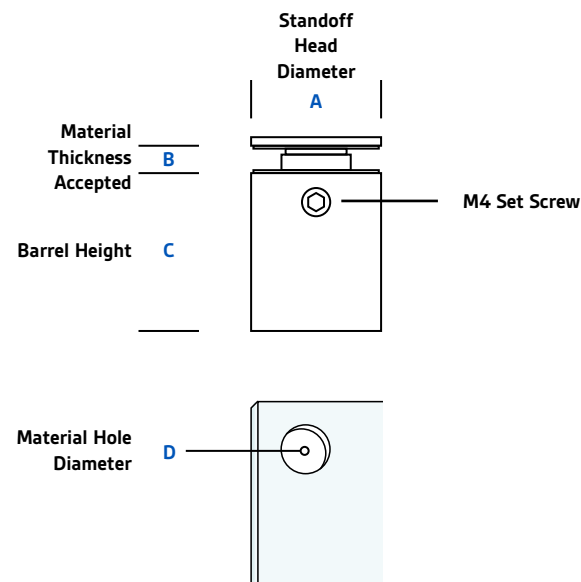

Standoff Head A	Material Thickness Accepted B	Standoff Barrel Height C	Material Hole Diameter D	Satin Brushed 201 (SS)	Satin Brushed 304 (SP)
1/2"	1/8" and 3/16"	1/2"	3/8"	CPF14.14	N/A
7/8"	1/8" and 1/2"	7/8"	3/8"	CPF22.22	CPF22.22S
1-3/16"	1/8" and 3/4"	1-3/16"	3/8"	CPF30.30	CPF30.30S

For 1/2" Drywall Hardware: Screw 2208 and anchor ANC5, ANC5Z. Concrete Hardware: Concrete Hardware: screw 2208 and anchor ANC1  
 For 7/8" and 1-3/16" Drywall Hardware: Screw 2216 and anchor ANC6, ANC6Z. Concrete Hardware: Concrete Hardware: screw 2216 and anchor ANC2  
 \* Mounting hardware not included. \* Non-threaded barrel.

## Tamper Proof Flat Head Standoffs

<b>Product</b>	Head Barrel
<b>Unique Features</b>	Indoor & Outdoor Use Wall mounted 3 Different Diameters 4 Different Heights
<b>Area Of Use</b>	Signage Wayfinder Display Advertising
<b>Additional Details</b>	Non-threaded stud Tamper Proof

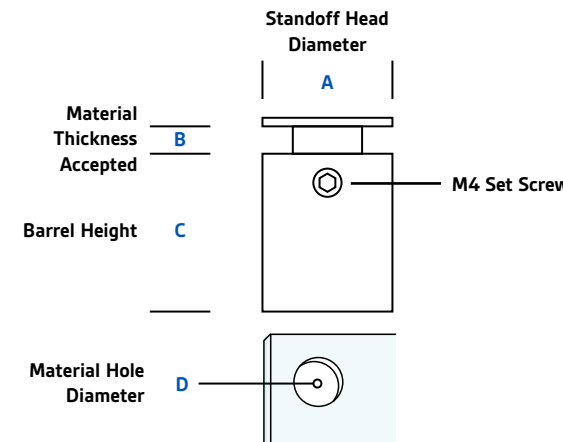

Standoff Head Diameter A	Material Thickness Accepted B	Standoff Barrel Height C	Material Hole Diameter D	Aluminum Clear (A)	Aluminum Black (B)	Stainless Steel Brushed (201) (SS)	Stainless Steel Satin Brushed (304) (SS)
	0 to 1/16"	1/2"		GS050-050A	GS050-050B	GS050-050S	GS050-050S304
1/2"	0 to 1/2"	1"	5/16"	GS050-100A	GS050-100B	GS050-100S	GS050-100S304
	0 to 1/2"	2"		GS050-200A	GS050-200B	GS050-200S	GS050-200S304
	0 to 1/16"	5/16"		GS075-050A	GS075-050B	GS075-050S	GS075-050S304
3/4"	0 to 1/2"	1"	7/16"	GS075-100A	GS075-100B	GS075-100S	GS075-100S304
	0 to 1/2"	2"		GS075-200A	GS075-200B	GS075-200S	GS075-200S304
	0 to 1/16"	5/16"		GS100-050A	GS100-050B	GS100-050S	GS100-050S304
1"	0 to 1/2"	1"	7/16"	GS100-100A	GS100-100B	GS100-100S	GS100-100S304
	0 to 1/2"	2"		GS100-200A	GS100-200B	GS100-200S	GS100-200S304

Use for drywall: screw 2208 and anchor ANC5, ANC5Z. Use for concrete: screw 2208 and anchor ANC1  
 \* Mounting hardware not included. \* Non-threaded stud.



## Stainless Steel Hollow Standoffs

- Product**
  - Heads
  - Washers
  - Barrels
- Unique Features**
  - Indoor Use Only
  - Wall Mounted
  - 5 Different Heights
  - 6 Different Diameters
  - 2 Finishes
- Area Of Use**
  - Signage
  - Wayfinder
  - Display
  - Advertising
- Additional Details**
  - Eco-Lite Stainless Steel



All Hollow Standoffs are FINAL SALE! NO RETURNS, NO REFUNDS!

## Stainless Steel Hollow Standoffs

Its hollow design provides a lightweight yet sturdy solution for structural projects.

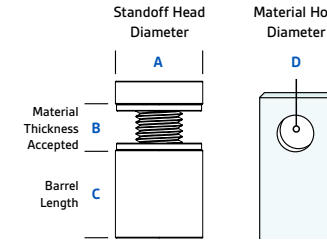

Standoff Head Diameter A	Material Thickness Accepted B	Standoff Barrel Height C	Material Hole Diameter D	Satin Brushed (HBSL)	Satin Brushed Kits (HBSL)	Matte Black (MB)	Matte Black Kits (MB)
1/2"	0 to 1/4"	1/2"	3/8"	HBSL12-12	HBSL12-12-KIT	HBSL12-12MB	HBSL12-12MB-KIT
	0 to 1/2"	3/4"		HBSL12-25	HBSL12-25-KIT	HBSL12-25MB	HBSL12-25MB-KIT
	0 to 1/2"	1"		HBSL12-30	HBSL12-30-KIT	HBSL12-30MB	HBSL12-30MB-KIT
	0 to 1/2"	1-3/4"		HBSL12-50	HBSL12-50-KIT	HBSL12-50MB	HBSL12-50MB-KIT
5/8"	0 to 1/2"	2-1/2"	7/16"	HBSL12-70	HBSL12-70-KIT	HBSL12-70MB	HBSL12-70MB-KIT
	0 to 1/4"	1/2"		HBSL16-12	HBSL16-12-KIT	HBSL16-12MB	HBSL16-12MB-KIT
	0 to 1/2"	3/4"		HBSL16-25	HBSL16-25-KIT	HBSL16-25MB	HBSL16-25MB-KIT
	0 to 1/2"	1"		HBSL16-30	HBSL16-30-KIT	HBSL16-30MB	HBSL16-30MB-KIT
3/4"	0 to 1/2"	1-3/4"	7/16"	HBSL16-50	HBSL16-50-KIT	HBSL16-50MB	HBSL16-50MB-KIT
	0 to 1/2"	2-1/2"		HBSL16-70	HBSL16-70-KIT	HBSL16-70MB	HBSL16-70MB-KIT
	0 to 1/4"	1/2"		HBSL19-12	HBSL19-12-KIT	HBSL19-12MB	HBSL19-12MB-KIT
	0 to 1/2"	3/4"		HBSL19-25	HBSL19-25-KIT	HBSL19-25MB	HBSL19-25MB-KIT
7/8"	0 to 1/2"	1"	7/16"	HBSL19-30	HBSL19-30-KIT	HBSL19-30MB	HBSL19-30MB-KIT
	0 to 1/2"	1-3/4"		HBSL19-50	HBSL19-50-KIT	HBSL19-50MB	HBSL19-50MB-KIT
	0 to 1/2"	2-1/2"		HBSL19-70	HBSL19-70-KIT	HBSL19-70MB	HBSL19-70MB-KIT
	0 to 1/4"	1/2"		HBSL22-12	HBSL22-12-KIT	HBSL22-12MB	HBSL22-12MB-KIT
1"	0 to 1/2"	3/4"	7/16"	HBSL22-25	HBSL22-25-KIT	HBSL22-25MB	HBSL22-25MB-KIT
	0 to 1/2"	1"		HBSL22-30	HBSL22-30-KIT	HBSL22-30MB	HBSL22-30MB-KIT
	0 to 1/2"	1-3/4"		HBSL22-50	HBSL22-50-KIT	HBSL22-50MB	HBSL22-50MB-KIT
	0 to 1/2"	2-1/2"		HBSL22-70	HBSL22-70-KIT	HBSL22-70MB	HBSL22-70MB-KIT
1-1/4"	0 to 1/4"	1/2"	7/16"	HBSL25-12	HBSL25-12-KIT	HBSL25-12MB	HBSL25-12MB-KIT
	0 to 1/2"	3/4"		HBSL25-25	HBSL25-25-KIT	HBSL25-25MB	HBSL25-25MB-KIT
	0 to 1/2"	1"		HBSL25-30	HBSL25-30-KIT	HBSL25-30MB	HBSL25-30MB-KIT
	0 to 1/2"	1-3/4"		HBSL25-50	HBSL25-50-KIT	HBSL25-50MB	HBSL25-50MB-KIT
1-1/4"	0 to 1/2"	2-1/2"	7/16"	HBSL25-70	HBSL25-70-KIT	HBSL25-70MB	HBSL25-70MB-KIT
	0 to 1/4"	1/2"		HBSL30-12	HBSL30-12-KIT	HBSL30-12MB	HBSL30-12MB-KIT
	0 to 1/2"	3/4"		HBSL30-25	HBSL30-25-KIT	HBSL30-25MB	HBSL30-25MB-KIT
	0 to 1/2"	1"		HBSL30-30	HBSL30-30-KIT	HBSL30-30MB	HBSL30-30MB-KIT
1-1/4"	0 to 1/2"	1-3/4"	7/16"	HBSL30-50	HBSL30-50-KIT	HBSL30-50MB	HBSL30-50MB-KIT
	0 to 1/2"	2-1/2"		HBSL30-70	HBSL30-70-KIT	HBSL30-70MB	HBSL30-70MB-KIT

All Hollow Standoffs are FINAL SALE! NO RETURNS, NO REFUNDS!

1/2" & 5/8" Diameter: Use for drywall: screw 2208 and anchor ANC5, ANC5Z. Use for concrete: screw 2208 and anchor ANC1  
 3/4" to 1-1/4" Diameter: Use for drywall: screw 2216 and anchor ANC6, ANC6Z. Use for concrete: screw 2216 and anchor ANC2

## Aluminum Standoffs



# Aluminum Standoffs

The Sleek Lines And Appealing Look Of Aluminum  
With 8 Different Finishes

**Long Lasting**  
Indoor & Outdoor

**Robust**  
Solid Material

**Aesthetic**  
Elegant Finishes



## Aluminum Standoffs

- **Units** do not include hardware.
- **Kits** come with 4 standoffs, mounting hardware and instruction guide.
- **Head Replacements** include 2 nylon washers.



Standoff Head Diameter	Material Thickness Accepted	Standoff Barrel Height	Material Hole Diameter	Clear (A)	Clear Kits (A)	Clear Head Replacement (A)
A	B	C	D			
1/2"	0 to 1/4"	1/2"	3/8"	AL12-12A	AL12-12A-KIT	AL12-12A-HEAD
	0 to 1/2"	3/4"		AL12-25A	AL12-25A-KIT	AL12-A-HEAD
	0 to 1/2"	1"		AL12-30A	AL12-30A-KIT	
	0 to 1/2"	1-3/4"		AL12-50A	AL12-50A-KIT	
5/8"	0 to 1/2"	2-1/2"	7/16"	AL12-70A	AL12-70A-KIT	AL16-A-HEAD
	0 to 1/4"	1/2"		AL16-12A	AL16-12A-KIT	
	0 to 1/2"	3/4"		AL16-25A	AL16-25A-KIT	
	0 to 1/2"	1"		AL16-30A	AL16-30A-KIT	
3/4"	0 to 1/2"	1-3/4"	7/16"	AL16-50A	AL16-50A-KIT	AL19-A-HEAD
	0 to 1/2"	2-1/2"		AL16-70A	AL16-70A-KIT	
	0 to 1/4"	1/2"		AL19-12A	AL19-12A-KIT	
	0 to 1/2"	3/4"		AL19-25A	AL19-25A-KIT	
7/8"	0 to 1/2"	1"	7/16"	AL19-30A	AL19-30A-KIT	AL22-A-HEAD
	0 to 1/2"	1-3/4"		AL19-50A	AL19-50A-KIT	
	0 to 1/2"	2-1/2"		AL19-70A	AL19-70A-KIT	
	0 to 1/4"	1/2"		AL22-12A	AL22-12A-KIT	
1"	0 to 1/2"	3/4"	7/16"	AL22-25A	AL22-25A-KIT	AL25-A-HEAD
	0 to 1/2"	1"		AL22-30A	AL22-30A-KIT	
	0 to 1/2"	1-3/4"		AL22-50A	AL22-50A-KIT	
	0 to 1/2"	2-1/2"		AL22-70A	AL22-70A-KIT	
1-1/4"	0 to 1/4"	1/2"	7/16"	AL25-12A	AL25-12A-KIT	AL25-12A-HEAD
	0 to 1/2"	3/4"		AL25-25A	AL25-25A-KIT	AL25-A-HEAD
	0 to 1/2"	1"		AL25-30A	AL25-30A-KIT	
	0 to 1/2"	1-3/4"		AL25-50A	AL25-50A-KIT	
1-1/4"	0 to 1/2"	2-1/2"	7/16"	AL25-70A	AL25-70A-KIT	AL30-A-HEAD
	0 to 1/4"	1/2"		AL30-12A	AL30-12A-KIT	
	0 to 1/2"	3/4"		AL30-25A	AL30-25A-KIT	
	0 to 1/2"	1"		AL30-30A	AL30-30A-KIT	
1-1/4"	0 to 1/2"	1-3/4"	7/16"	AL30-50A	AL30-50A-KIT	AL30-A-HEAD
	0 to 1/2"	2-1/2"		AL30-70A	AL30-70A-KIT	

1/2" & 5/8" Diameter: Use for drywall: screw 2208 and anchor ANC5, ANC5Z. Use for concrete: screw 2208 and anchor ANC1  
3/4" to 1-1/4" Diameter: Use for drywall: screw 2216 and anchor ANC6, ANC6Z. Use for concrete: screw 2216 and anchor ANC2

### Standoff Selection Guide

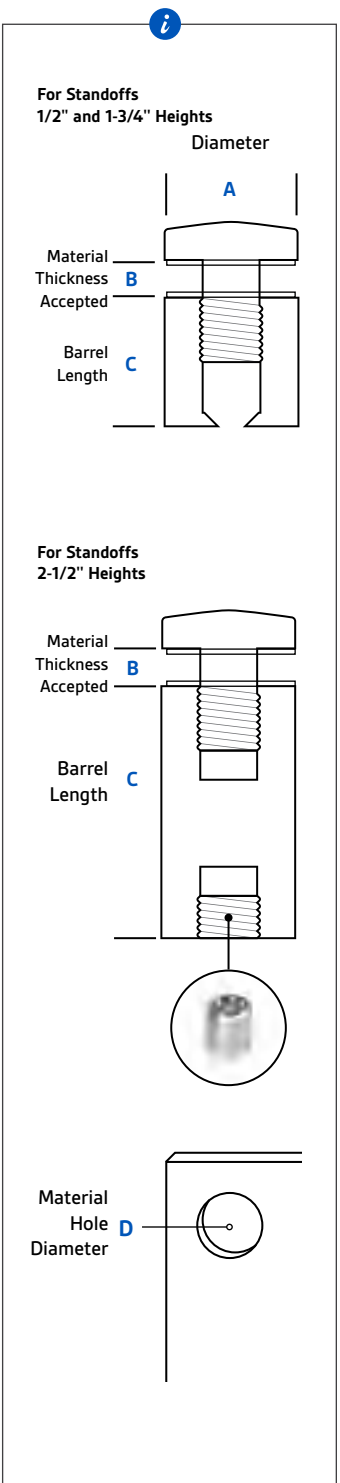

## Aluminum Standoffs

- **Units** do not include hardware.
- **Kits** come with 4 standoffs, mounting hardware and instruction guide.
- **Head Replacements** include 2 nylon washers.

\* See page 25 for selection guide

Standoff Head Diameter	Material Thickness Accepted	Standoff Barrel Height	Material Hole Diameter	Shiny (AS)	Shiny Kits (AS)	Shiny Head Replacement (AS)	Black (B)	Black Kits (B)	Black Head Replacement (B)
A	B	C	D						
1/2"	0 to 1/4"	1/2"	3/8"	AL12-12AS	AL12-12AS-KIT	AL12-12AS-HEAD	AL12-12B	AL12-12B-KIT	AL12-12B-HEAD
	0 to 1/2"	3/4"		AL12-25AS	AL12-25AS-KIT		AL12-25B	AL12-25B-KIT	
	0 to 1/2"	1"		AL12-30AS	AL12-30AS-KIT	AL12-AS-HEAD	AL12-30B	AL12-30B-KIT	AL12-B-HEAD
	0 to 1/2"	1-3/4"		AL12-50AS	AL12-50AS-KIT		AL12-50B	AL12-50B-KIT	
	0 to 1/2"	2-1/2"		AL12-70AS	AL12-70AS-KIT		AL12-70B	AL12-70B-KIT	
5/8"	0 to 1/4"	1/2"	7/16"	AL16-12AS	AL16-12AS-KIT	AL16-12AS-HEAD	AL16-12B	AL16-12B-KIT	AL16-12B-HEAD
	0 to 1/2"	3/4"		AL16-25AS	AL16-25AS-KIT		AL16-25B	AL16-25B-KIT	
	0 to 1/2"	1"		AL16-30AS	AL16-30AS-KIT	AL16-AS-HEAD	AL16-30B	AL16-30B-KIT	AL16-B-HEAD
	0 to 1/2"	1-3/4"		AL16-50AS	AL16-50AS-KIT		AL16-50B	AL16-50B-KIT	
	0 to 1/2"	2-1/2"		AL16-70AS	AL16-70AS-KIT		AL16-70B	AL16-70B-KIT	
3/4"	0 to 1/4"	1/2"	7/16"	AL19-12AS	AL19-12AS-KIT	AL19-12AS-HEAD	AL19-12B	AL19-12B-KIT	AL19-12B-HEAD
	0 to 1/2"	3/4"		AL19-25AS	AL19-25AS-KIT		AL19-25B	AL19-25B-KIT	
	0 to 1/2"	1"		AL19-30AS	AL19-30AS-KIT	AL19-AS-HEAD	AL19-30B	AL19-30B-KIT	AL19-B-HEAD
	0 to 1/2"	1-3/4"		AL19-50AS	AL19-50AS-KIT		AL19-50B	AL19-50B-KIT	
	0 to 1/2"	2-1/2"		AL19-70AS	AL19-70AS-KIT		AL19-70B	AL19-70B-KIT	
7/8"	0 to 1/4"	1/2"	7/16"	AL22-12AS	AL22-12AS-KIT	AL22-12AS-HEAD	AL22-12B	AL22-12B-KIT	AL22-12B-HEAD
	0 to 1/2"	3/4"		AL22-25AS	AL22-25AS-KIT		AL22-25B	AL22-25B-KIT	
	0 to 1/2"	1"		AL22-30AS	AL22-30AS-KIT	AL22-AS-HEAD	AL22-30B	AL22-30B-KIT	AL22-B-HEAD
	0 to 1/2"	1-3/4"		AL22-50AS	AL22-50AS-KIT		AL22-50B	AL22-50B-KIT	
	0 to 1/2"	2-1/2"		AL22-70AS	AL22-70AS-KIT		AL22-70B	AL22-70B-KIT	
1"	0 to 1/4"	1/2"	7/16"	AL25-12AS	AL25-12AS-KIT	AL25-12AS-HEAD	AL25-12B	AL25-12B-KIT	AL25-12B-HEAD
	0 to 1/2"	3/4"		AL25-25AS	AL25-25AS-KIT		AL25-25B	AL25-25B-KIT	
	0 to 1/2"	1"		AL25-30AS	AL25-30AS-KIT	AL25-AS-HEAD	AL25-30B	AL25-30B-KIT	AL25-B-HEAD
	0 to 1/2"	1-3/4"		AL25-50AS	AL25-50AS-KIT		AL25-50B	AL25-50B-KIT	
	0 to 1/2"	2-1/2"		AL25-70AS	AL25-70AS-KIT		AL25-70B	AL25-70B-KIT	
1-1/4"	0 to 1/4"	1/2"	7/16"	AL30-12AS	AL30-12AS-KIT	AL30-12AS-HEAD	AL30-12B	AL30-12B-KIT	AL30-12B-HEAD
	0 to 1/2"	3/4"		AL30-25AS	AL30-25AS-KIT		AL30-25B	AL30-25B-KIT	
	0 to 1/2"	1"		AL30-30AS	AL30-30AS-KIT	AL30-AS-HEAD	AL30-30B	AL30-30B-KIT	AL30-B-HEAD
	0 to 1/2"	1-3/4"		AL30-50AS	AL30-50AS-KIT		AL30-50B	AL30-50B-KIT	
	0 to 1/2"	2-1/2"		AL30-70AS	AL30-70AS-KIT		AL30-70B	AL30-70B-KIT	

1/2" & 5/8" Diameter: Use for drywall: screw 2208 and anchor ANC5, ANC5Z. Use for concrete: screw 2208 and anchor ANC1  
 3/4" to 1-1/4" Diameter: Use for drywall: screw 2216 and anchor ANC6, ANC6Z. Use for concrete: screw 2216 and anchor ANC2

## Aluminum Standoffs



Gold (G)	Gold Kits (G)	Gold Head Replacement (G)	Champagne (BR)	Champagne Kits (BR)	Champagne Head Replacement (BR)	Matte Champagne (MBR)	Matte Champagne Kits (MBR)	Matte Champagne Head Replacement (MBR)
AL12-12G	AL12-12G-KIT	AL12-12G-HEAD	AL12-12BR	AL12-12BR-KIT	AL12-12BR-HEAD	AL12-12MBR	AL12-12MBR-KIT	AL12-12MBR-HEAD
AL12-25G	AL12-25G-KIT	AL12-G-HEAD	AL12-25BR	AL12-25BR-KIT	AL12-BR-HEAD	AL12-25MBR	AL12-25MBR-KIT	AL12-MBR-HEAD
AL12-30G	AL12-30G-KIT		AL12-30BR	AL12-30BR-KIT		AL12-30MBR	AL12-30MBR-KIT	
AL12-50G	AL12-50G-KIT		AL12-50BR	AL12-50BR-KIT		AL12-50MBR	AL12-50MBR-KIT	
AL12-70G	AL12-70G-KIT		AL12-70BR	AL12-70BR-KIT		AL12-70MBR	AL12-70MBR-KIT	
AL16-12G	AL16-12G-KIT		AL16-12G-HEAD	AL16-12BR		AL16-12BR-KIT	AL16-12BR-HEAD	
AL16-25G	AL16-25G-KIT	AL16-G-HEAD	AL16-25BR	AL16-25BR-KIT	AL16-BR-HEAD	AL16-25MBR	AL16-25MBR-KIT	AL16-MBR-HEAD
AL16-30G	AL16-30G-KIT		AL16-30BR	AL16-30BR-KIT		AL16-30MBR	AL16-30MBR-KIT	
AL16-50G	AL16-50G-KIT		AL16-50BR	AL16-50BR-KIT		AL16-50MBR	AL16-50MBR-KIT	
AL16-70G	AL16-70G-KIT		AL16-70BR	AL16-70BR-KIT		AL16-70MBR	AL16-70MBR-KIT	
AL19-12G	AL19-12G-KIT		AL19-12G-HEAD	AL19-12BR		AL19-12BR-KIT	AL19-12BR-HEAD	
AL19-25G	AL19-25G-KIT	AL19-G-HEAD	AL19-25BR	AL19-25BR-KIT	AL19-BR-HEAD	AL19-25MBR	AL19-25MBR-KIT	AL19-MBR-HEAD
AL19-30G	AL19-30G-KIT		AL19-30BR	AL19-30BR-KIT		AL19-30MBR	AL19-30MBR-KIT	
AL19-50G	AL19-50G-KIT		AL19-50BR	AL19-50BR-KIT		AL19-50MBR	AL19-50MBR-KIT	
AL19-70G	AL19-70G-KIT		AL19-70BR	AL19-70BR-KIT		AL19-70MBR	AL19-70MBR-KIT	
AL22-12G	AL22-12G-KIT		AL22-12G-HEAD	AL22-12BR		AL22-12BR-KIT	AL22-12BR-HEAD	
AL22-25G	AL22-25G-KIT	AL22-G-HEAD	AL22-25BR	AL22-25BR-KIT	AL22-BR-HEAD	AL22-25MBR	AL22-25MBR-KIT	AL22-MBR-HEAD
AL22-30G	AL22-30G-KIT		AL22-30BR	AL22-30BR-KIT		AL22-30MBR	AL22-30MBR-KIT	
AL22-50G	AL22-50G-KIT		AL22-50BR	AL22-50BR-KIT		AL22-50MBR	AL22-50MBR-KIT	
AL22-70G	AL22-70G-KIT		AL22-70BR	AL22-70BR-KIT		AL22-70MBR	AL22-70MBR-KIT	
AL25-12G	AL25-12G-KIT		AL25-12G-HEAD	AL25-12BR		AL25-12BR-KIT	AL25-12BR-HEAD	
AL25-25G	AL25-25G-KIT	AL25-G-HEAD	AL25-25BR	AL25-25BR-KIT	AL25-BR-HEAD	AL25-25MBR	AL25-25MBR-KIT	AL25-MBR-HEAD
AL25-30G	AL25-30G-KIT		AL25-30BR	AL25-30BR-KIT		AL25-30MBR	AL25-30MBR-KIT	
AL25-50G	AL25-50G-KIT		AL25-50BR	AL25-50BR-KIT		AL25-50MBR	AL25-50MBR-KIT	
AL25-70G	AL25-70G-KIT		AL25-70BR	AL25-70BR-KIT		AL25-70MBR	AL25-70MBR-KIT	
AL30-12G	AL30-12G-KIT		AL30-12G-HEAD	AL30-12BR		AL30-12BR-KIT	AL30-12BR-HEAD	
AL30-25G	AL30-25G-KIT	AL30-G-HEAD	AL30-25BR	AL30-25BR-KIT	AL30-BR-HEAD	AL30-25MBR	AL30-25MBR-KIT	AL30-MBR-HEAD
AL30-30G	AL30-30G-KIT		AL30-30BR	AL30-30BR-KIT		AL30-30MBR	AL30-30MBR-KIT	
AL30-50G	AL30-50G-KIT		AL30-50BR	AL30-50BR-KIT		AL30-50MBR	AL30-50MBR-KIT	
AL30-70G	AL30-70G-KIT		AL30-70BR	AL30-70BR-KIT		AL30-70MBR	AL30-70MBR-KIT	

1/2" & 5/8" Diameter: Use for drywall: screw 2208 and anchor ANC5, ANC5Z. Use for concrete: screw 2208 and anchor ANC1  
 3/4" to 1-1/4" Diameter: Use for drywall: screw 2216 and anchor ANC6, ANC6Z. Use for concrete: screw 2216 and anchor ANC2



## Aluminum Standoffs

- **Units** do not include hardware.
- **Kits** come with 4 standoffs, mounting hardware and instruction guide.
- **Head Replacements** include 2 nylon washers.

\* See page 25 for selection guide

Standoff Head Diameter	Material Thickness Accepted	Standoff Barrel Height	Material Hole Diameter	Bronze (AB)	Bronze Kits (AB)	Bronze Head Replacement (AB)	Titanium (T)	Titanium Kits (T)	Titanium Head Replacement (T)
A*	B*	C*	D*						
1/2"	0 to 1/4"	1/2"	3/8"	AL12-12AB	AL12-12AB-KIT	AL12-12AB-HEAD	AL12-12T	AL12-12T-KIT	AL12-12T-HEAD
	0 to 1/2"	3/4"		AL12-25AB	AL12-25AB-KIT	AL12-AB-HEAD	AL12-25T	AL12-25T-KIT	AL12-T-HEAD
	0 to 1/2"	1"		AL12-30AB	AL12-30AB-KIT		AL12-30T	AL12-30T-KIT	
	0 to 1/2"	1-3/4"		AL12-50AB	AL12-50AB-KIT		AL12-50T	AL12-50T-KIT	
5/8"	0 to 1/4"	1/2"	7/16"	AL12-70AB	AL12-70AB-KIT	AL16-AB-HEAD	AL12-70T	AL12-70T-KIT	AL16-T-HEAD
	0 to 1/2"	3/4"		AL16-12AB	AL16-12AB-KIT		AL16-12T	AL16-12T-KIT	
	0 to 1/2"	1"		AL16-25AB	AL16-25AB-KIT		AL16-25T	AL16-25T-KIT	
	0 to 1/2"	1-3/4"		AL16-30AB	AL16-30AB-KIT		AL16-30T	AL16-30T-KIT	
3/4"	0 to 1/2"	2-1/2"	7/16"	AL16-50AB	AL16-50AB-KIT	AL19-AB-HEAD	AL16-50T	AL16-50T-KIT	AL19-T-HEAD
	0 to 1/4"	1/2"		AL19-12AB	AL19-12AB-KIT		AL19-12T	AL19-12T-KIT	
	0 to 1/2"	3/4"		AL19-25AB	AL19-25AB-KIT		AL19-25T	AL19-25T-KIT	
	0 to 1/2"	1"		AL19-30AB	AL19-30AB-KIT		AL19-30T	AL19-30T-KIT	
7/8"	0 to 1/2"	1-3/4"	7/16"	AL19-50AB	AL19-50AB-KIT	AL22-AB-HEAD	AL19-50T	AL19-50T-KIT	AL22-T-HEAD
	0 to 1/2"	2-1/2"		AL19-70AB	AL19-70AB-KIT		AL19-70T	AL19-70T-KIT	
	0 to 1/4"	1/2"		AL22-12AB	AL22-12AB-KIT		AL22-12T	AL22-12T-KIT	
	0 to 1/2"	3/4"		AL22-25AB	AL22-25AB-KIT		AL22-25T	AL22-25T-KIT	
1"	0 to 1/2"	1"	7/16"	AL22-30AB	AL22-30AB-KIT	AL25-AB-HEAD	AL22-30T	AL22-30T-KIT	AL25-T-HEAD
	0 to 1/2"	1-3/4"		AL22-50AB	AL22-50AB-KIT		AL22-50T	AL22-50T-KIT	
	0 to 1/2"	2-1/2"		AL22-70AB	AL22-70AB-KIT		AL22-70T	AL22-70T-KIT	
	0 to 1/4"	1/2"		AL25-12AB	AL25-12AB-KIT		AL25-12T	AL25-12T-KIT	
1-1/4"	0 to 1/2"	3/4"	7/16"	AL25-25AB	AL25-25AB-KIT	AL30-AB-HEAD	AL25-25T	AL25-25T-KIT	AL30-T-HEAD
	0 to 1/2"	1"		AL25-30AB	AL25-30AB-KIT		AL25-30T	AL25-30T-KIT	
	0 to 1/2"	1-3/4"		AL25-50AB	AL25-50AB-KIT		AL25-50T	AL25-50T-KIT	
	0 to 1/2"	2-1/2"		AL25-70AB	AL25-70AB-KIT		AL25-70T	AL25-70T-KIT	
1-1/4"	0 to 1/4"	1/2"	7/16"	AL30-12AB	AL30-12AB-KIT	AL30-AB-HEAD	AL30-12T	AL30-12T-KIT	AL30-T-HEAD
	0 to 1/2"	3/4"		AL30-25AB	AL30-25AB-KIT		AL30-25T	AL30-25T-KIT	
	0 to 1/2"	1"		AL30-30AB	AL30-30AB-KIT		AL30-30T	AL30-30T-KIT	
	0 to 1/2"	1-3/4"		AL30-50AB	AL30-50AB-KIT		AL30-50T	AL30-50T-KIT	
1-1/4"	0 to 1/2"	2-1/2"	7/16"	AL30-70AB	AL30-70AB-KIT	AL30-AB-HEAD	AL30-70T	AL30-70T-KIT	AL30-T-HEAD

1/2" & 5/8" Diameter: Use for drywall: screw 2208 and anchor ANC5, ANC5Z. Use for concrete: screw 2208 and anchor ANC1  
 3/4" to 1-1/4" Diameter: Use for drywall: screw 2216 and anchor ANC6, ANC6Z. Use for concrete: screw 2216 and anchor ANC2

## Sign Setter



**Save Your Time and Energy!**

**Tool for Easy Sign Installation**

SKU: SIGNSETTER

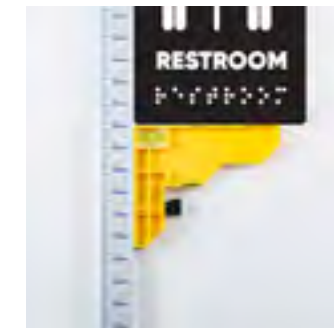

**Carry Bag Included**

## Aluminum Tamper Proof Standoffs



# Tamper Proof Standoffs

The Reverse Standoff "Left-Handed" Thread System Helps Ensure The Cap Won't Be Misplaced

**Long Lasting**

Indoor & Outdoor

**Robust**

Solid Material

**Aesthetic**

Elegant Finishes



**8 Different Finishes**



## Aluminum Tamper Proof Standoffs

- Units do not include hardware.
- Kits come with 4 standoffs, mounting hardware and instruction guide.



Standoff Head Diameter	Material Thickness Accepted	Standoff Barrel Height	Material Hole Diameter	Clear (A)	Clear Kits (A)	Shiny (AS)	Shiny Kits (AS)
A	B	C	D				
1/2"	0 to 1/4"	1/2"	3/8"	FAH12-12A	FAH12-12A-KIT	FAH12-12AS	FAH12-12AS-KIT
	0 to 1/2"	3/4"		FAH12-25A	FAH12-25A-KIT	FAH12-25AS	FAH12-25AS-KIT
	0 to 1/2"	1"		FAH12-30A	FAH12-30A-KIT	FAH12-30AS	FAH12-30AS-KIT
	0 to 1/2"	1-3/4"		FAH12-50A	FAH12-50A-KIT	FAH12-50AS	FAH12-50AS-KIT
5/8"	0 to 1/2"	2-1/2"	7/16"	FAH12-70A	FAH12-70A-KIT	FAH12-70AS	FAH12-70AS-KIT
	0 to 1/4"	1/2"		FAH16-12A	FAH16-12A-KIT	FAH16-12AS	FAH16-12AS-KIT
	0 to 1/2"	3/4"		FAH16-25A	FAH16-25A-KIT	FAH16-25AS	FAH16-25AS-KIT
	0 to 1/2"	1"		FAH16-30A	FAH16-30A-KIT	FAH16-30AS	FAH16-30AS-KIT
3/4"	0 to 1/2"	1-3/4"	7/16"	FAH16-50A	FAH16-50A-KIT	FAH16-50AS	FAH16-50AS-KIT
	0 to 1/2"	2-1/2"		FAH16-70A	FAH16-70A-KIT	FAH16-70AS	FAH16-70AS-KIT
	0 to 1/4"	1/2"		FAH19-12A	FAH19-12A-KIT	FAH19-12AS	FAH19-12AS-KIT
	0 to 1/2"	3/4"		FAH19-25A	FAH19-25A-KIT	FAH19-25AS	FAH19-25AS-KIT
7/8"	0 to 1/2"	1"	7/16"	FAH19-30A	FAH19-30A-KIT	FAH19-30AS	FAH19-30AS-KIT
	0 to 1/2"	1-3/4"		FAH19-50A	FAH19-50A-KIT	FAH19-50AS	FAH19-50AS-KIT
	0 to 1/2"	2-1/2"		FAH19-70A	FAH19-70A-KIT	FAH19-70AS	FAH19-70AS-KIT
	0 to 1/4"	1/2"		FAH22-12A	FAH22-12A-KIT	FAH22-12AS	FAH22-12AS-KIT
1"	0 to 1/2"	3/4"	7/16"	FAH22-25A	FAH22-25A-KIT	FAH22-25AS	FAH22-25AS-KIT
	0 to 1/2"	1"		FAH22-30A	FAH22-30A-KIT	FAH22-30AS	FAH22-30AS-KIT
	0 to 1/2"	1-3/4"		FAH22-50A	FAH22-50A-KIT	FAH22-50AS	FAH22-50AS-KIT
	0 to 1/2"	2-1/2"		FAH22-70A	FAH22-70A-KIT	FAH22-70AS	FAH22-70AS-KIT
1-1/4"	0 to 1/4"	1/2"	7/16"	FAH25-12A	FAH25-12A-KIT	FAH25-12AS	FAH25-12AS-KIT
	0 to 1/2"	3/4"		FAH25-25A	FAH25-25A-KIT	FAH25-25AS	FAH25-25AS-KIT
	0 to 1/2"	1"		FAH25-30A	FAH25-30A-KIT	FAH25-30AS	FAH25-30AS-KIT
	0 to 1/2"	1-3/4"		FAH25-50A	FAH25-50A-KIT	FAH25-50AS	FAH25-50AS-KIT
1-1/4"	0 to 1/2"	2-1/2"	7/16"	FAH25-70A	FAH25-70A-KIT	FAH25-70AS	FAH25-70AS-KIT
	0 to 1/4"	1/2"		FAH30-12A	FAH30-12A-KIT	FAH30-12AS	FAH30-12AS-KIT
	0 to 1/2"	3/4"		FAH30-25A	FAH30-25A-KIT	FAH30-25AS	FAH30-25AS-KIT
	0 to 1/2"	1"		FAH30-30A	FAH30-30A-KIT	FAH30-30AS	FAH30-30AS-KIT
1-1/4"	0 to 1/2"	1-3/4"	7/16"	FAH30-50A	FAH30-50A-KIT	FAH30-50AS	FAH30-50AS-KIT
	0 to 1/2"	2-1/2"		FAH30-70A	FAH30-70A-KIT	FAH30-70AS	FAH30-70AS-KIT

1/2" & 5/8" Diameter: Use for drywall: screw 2208 and anchor ANC5, ANC5Z. Use for concrete: screw 2208 and anchor ANC1  
 3/4" to 1-1/4" Diameter: Use for drywall: screw 2216 and anchor ANC6, ANC6Z. Use for concrete: screw 2216 and anchor ANC2

### Standoff Selection Guide

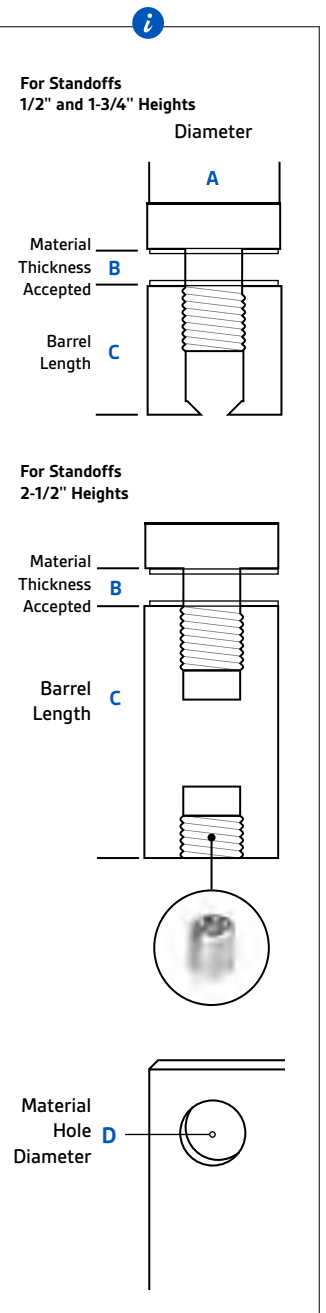



## Aluminum Tamper Proof Standoffs

- Units do not include hardware.
- Kits come with 4 standoffs, mounting hardware and instruction guide.

\* See page 31 for selection guide

Standoff Head Diameter	Material Thickness Accepted	Standoff Barrel Height	Material Hole Diameter	Black (B)	Black Kits (B)	Gold (G)	Gold Kits (G)
A	B	C	D				
1/2"	0 to 1/4"	1/2"	3/8"	FAH12-12B	FAH12-12B-KIT	FAH12-12G	FAH12-12G-KIT
	0 to 1/2"	3/4"		FAH12-25B	FAH12-25B-KIT	FAH12-25G	FAH12-25G-KIT
	0 to 1/2"	1"		FAH12-30B	FAH12-30B-KIT	FAH12-30G	FAH12-30G-KIT
	0 to 1/2"	1-3/4"		FAH12-50B	FAH12-50B-KIT	FAH12-50G	FAH12-50G-KIT
	0 to 1/2"	2-1/2"		FAH12-70B	FAH12-70B-KIT	FAH12-70G	FAH12-70G-KIT
5/8"	0 to 1/4"	1/2"	7/16"	FAH16-12B	FAH16-12B-KIT	FAH16-12G	FAH16-12G-KIT
	0 to 1/2"	3/4"		FAH16-25B	FAH16-25B-KIT	FAH16-25G	FAH16-25G-KIT
	0 to 1/2"	1"		FAH16-30B	FAH16-30B-KIT	FAH16-30G	FAH16-30G-KIT
	0 to 1/2"	1-3/4"		FAH16-50B	FAH16-50B-KIT	FAH16-50G	FAH16-50G-KIT
	0 to 1/2"	2-1/2"		FAH16-70B	FAH16-70B-KIT	FAH16-70G	FAH16-70G-KIT
3/4"	0 to 1/4"	1/2"	7/16"	FAH19-12B	FAH19-12B-KIT	FAH19-12G	FAH19-12G-KIT
	0 to 1/2"	3/4"		FAH19-25B	FAH19-25B-KIT	FAH19-25G	FAH19-25G-KIT
	0 to 1/2"	1"		FAH19-30B	FAH19-30B-KIT	FAH19-30G	FAH19-30G-KIT
	0 to 1/2"	1-3/4"		FAH19-50B	FAH19-50B-KIT	FAH19-50G	FAH19-50G-KIT
	0 to 1/2"	2-1/2"		FAH19-70B	FAH19-70B-KIT	FAH19-70G	FAH19-70G-KIT
7/8"	0 to 1/4"	1/2"	7/16"	FAH22-12B	FAH22-12B-KIT	FAH22-12G	FAH22-12G-KIT
	0 to 1/2"	3/4"		FAH22-25B	FAH22-25B-KIT	FAH22-25G	FAH22-25G-KIT
	0 to 1/2"	1"		FAH22-30B	FAH22-30B-KIT	FAH22-30G	FAH22-30G-KIT
	0 to 1/2"	1-3/4"		FAH22-50B	FAH22-50B-KIT	FAH22-50G	FAH22-50G-KIT
	0 to 1/2"	2-1/2"		FAH22-70B	FAH22-70B-KIT	FAH22-70G	FAH22-70G-KIT
1"	0 to 1/4"	1/2"	7/16"	FAH25-12B	FAH25-12B-KIT	FAH25-12G	FAH25-12G-KIT
	0 to 1/2"	3/4"		FAH25-25B	FAH25-25B-KIT	FAH25-25G	FAH25-25G-KIT
	0 to 1/2"	1"		FAH25-30B	FAH25-30B-KIT	FAH25-30G	FAH25-30G-KIT
	0 to 1/2"	1-3/4"		FAH25-50B	FAH25-50B-KIT	FAH25-50G	FAH25-50G-KIT
	0 to 1/2"	2-1/2"		FAH25-70B	FAH25-70B-KIT	FAH25-70G	FAH25-70G-KIT
1-1/4"	0 to 1/4"	1/2"	7/16"	FAH30-12B	FAH30-12B-KIT	FAH30-12G	FAH30-12G-KIT
	0 to 1/2"	3/4"		FAH30-25B	FAH30-25B-KIT	FAH30-25G	FAH30-25G-KIT
	0 to 1/2"	1"		FAH30-30B	FAH30-30B-KIT	FAH30-30G	FAH30-30G-KIT
	0 to 1/2"	1-3/4"		FAH30-50B	FAH30-50B-KIT	FAH30-50G	FAH30-50G-KIT
	0 to 1/2"	2-1/2"		FAH30-70B	FAH30-70B-KIT	FAH30-70G	FAH30-70G-KIT

1/2" & 5/8" Diameter: Use for drywall: screw 2208 and anchor ANC5, ANC5Z. Use for concrete: screw 2208 and anchor ANC1  
 3/4" to 1-1/4" Diameter: Use for drywall: screw 2216 and anchor ANC6, ANC6Z. Use for concrete: screw 2216 and anchor ANC2

## Aluminum Tamper Proof Standoffs



Champagne (BR)	Champagne Kits (BR)	Matte Champagne (MBR)	Matte Champagne Kits (MBR)	Bronze (AB)	Bronze (AB)	Titanium (T)	Titanium Kits (T)
FAH12-12BR	FAH12-12BR-KIT	FAH12-12MBR	FAH12-12MBR-KIT	FAH12-12AB	FAH12-12AB-KIT	FAH12-12T	FAH12-12T-KIT
FAH12-25BR	FAH12-25BR-KIT	FAH12-25MBR	FAH12-25MBR-KIT	FAH12-25AB	FAH12-25AB-KIT	FAH12-25T	FAH12-25T-KIT
FAH12-30BR	FAH12-30BR-KIT	FAH12-30MBR	FAH12-30MBR-KIT	FAH12-30AB	FAH12-30AB-KIT	FAH12-30T	FAH12-30T-KIT
FAH12-50BR	FAH12-50BR-KIT	FAH12-50MBR	FAH12-50MBR-KIT	FAH12-50AB	FAH12-50AB-KIT	FAH12-50T	FAH12-50T-KIT
FAH12-70BR	FAH12-70BR-KIT	FAH12-70MBR	FAH12-70MBR-KIT	FAH12-70AB	FAH12-70AB-KIT	FAH12-70T	FAH12-70T-KIT
FAH16-12BR	FAH16-12BR-KIT	FAH16-12MBR	FAH16-12MBR-KIT	FAH16-12AB	FAH16-12AB-KIT	FAH16-12T	FAH16-12T-KIT
FAH16-25BR	FAH16-25BR-KIT	FAH16-25MBR	FAH16-25MBR-KIT	FAH16-25AB	FAH16-25AB-KIT	FAH16-25T	FAH16-25T-KIT
FAH16-30BR	FAH16-30BR-KIT	FAH16-30MBR	FAH16-30MBR-KIT	FAH16-30AB	FAH16-30AB-KIT	FAH16-30T	FAH16-30T-KIT
FAH16-50BR	FAH16-50BR-KIT	FAH16-50MBR	FAH16-50MBR-KIT	FAH16-50AB	FAH16-50AB-KIT	FAH16-50T	FAH16-50T-KIT
FAH16-70BR	FAH16-70BR-KIT	FAH16-70MBR	FAH16-70MBR-KIT	FAH16-70AB	FAH16-70AB-KIT	FAH16-70T	FAH16-70T-KIT
FAH19-12BR	FAH19-12BR-KIT	FAH19-12MBR	FAH19-12MBR-KIT	FAH19-12AB	FAH19-12AB-KIT	FAH19-12T	FAH19-12T-KIT
FAH19-25BR	FAH19-25BR-KIT	FAH19-25MBR	FAH19-25MBR-KIT	FAH19-25AB	FAH19-25AB-KIT	FAH19-25T	FAH19-25T-KIT
FAH19-30BR	FAH19-30BR-KIT	FAH19-30MBR	FAH19-30MBR-KIT	FAH19-30AB	FAH19-30AB-KIT	FAH19-30T	FAH19-30T-KIT
FAH19-50BR	FAH19-50BR-KIT	FAH19-50MBR	FAH19-50MBR-KIT	FAH19-50AB	FAH19-50AB-KIT	FAH19-50T	FAH19-50T-KIT
FAH19-70BR	FAH19-70BR-KIT	FAH19-70MBR	FAH19-70MBR-KIT	FAH19-70AB	FAH19-70AB-KIT	FAH19-70T	FAH19-70T-KIT
FAH22-12BR	FAH22-12BR-KIT	FAH22-12MBR	FAH22-12MBR-KIT	FAH22-12AB	FAH22-12AB-KIT	FAH22-12T	FAH22-12T-KIT
FAH22-25BR	FAH22-25BR-KIT	FAH22-25MBR	FAH22-25MBR-KIT	FAH22-25AB	FAH22-25AB-KIT	FAH22-25T	FAH22-25T-KIT
FAH22-30BR	FAH22-30BR-KIT	FAH22-30MBR	FAH22-30MBR-KIT	FAH22-30AB	FAH22-30AB-KIT	FAH22-30T	FAH22-30T-KIT
FAH22-50BR	FAH22-50BR-KIT	FAH22-50MBR	FAH22-50MBR-KIT	FAH22-50AB	FAH22-50AB-KIT	FAH22-50T	FAH22-50T-KIT
FAH22-70BR	FAH22-70BR-KIT	FAH22-70MBR	FAH22-70MBR-KIT	FAH22-70AB	FAH22-70AB-KIT	FAH22-70T	FAH22-70T-KIT
FAH25-12BR	FAH25-12BR-KIT	FAH25-12MBR	FAH25-12MBR-KIT	FAH25-12AB	FAH25-12AB-KIT	FAH25-12T	FAH25-12T-KIT
FAH25-25BR	FAH25-25BR-KIT	FAH25-25MBR	FAH25-25MBR-KIT	FAH25-25AB	FAH25-25AB-KIT	FAH25-25T	FAH25-25T-KIT
FAH25-30BR	FAH25-30BR-KIT	FAH25-30MBR	FAH25-30MBR-KIT	FAH25-30AB	FAH25-30AB-KIT	FAH25-30T	FAH25-30T-KIT
FAH25-50BR	FAH25-50BR-KIT	FAH25-50MBR	FAH25-50MBR-KIT	FAH25-50AB	FAH25-50AB-KIT	FAH25-50T	FAH25-50T-KIT
FAH25-70BR	FAH25-70BR-KIT	FAH25-70MBR	FAH25-70MBR-KIT	FAH25-70AB	FAH25-70AB-KIT	FAH25-70T	FAH25-70T-KIT
FAH30-12BR	FAH30-12BR-KIT	FAH30-12MBR	FAH30-12MBR-KIT	FAH30-12AB	FAH30-12AB-KIT	FAH30-12T	FAH30-12T-KIT
FAH30-25BR	FAH30-25BR-KIT	FAH30-25MBR	FAH30-25MBR-KIT	FAH30-25AB	FAH30-25AB-KIT	FAH30-25T	FAH30-25T-KIT
FAH30-30BR	FAH30-30BR-KIT	FAH30-30MBR	FAH30-30MBR-KIT	FAH30-30AB	FAH30-30AB-KIT	FAH30-30T	FAH30-30T-KIT
FAH30-50BR	FAH30-50BR-KIT	FAH30-50MBR	FAH30-50MBR-KIT	FAH30-50AB	FAH30-50AB-KIT	FAH30-50T	FAH30-50T-KIT
FAH30-70BR	FAH30-70BR-KIT	FAH30-70MBR	FAH30-70MBR-KIT	FAH30-70AB	FAH30-70AB-KIT	FAH30-70T	FAH30-70T-KIT

1/2" & 5/8" Diameter: Use for drywall: screw 2208 and anchor ANC5, ANC5Z. Use for concrete: screw 2208 and anchor ANC1  
 3/4" to 1-1/4" Diameter: Use for drywall: screw 2216 and anchor ANC6, ANC6Z. Use for concrete: screw 2216 and anchor ANC2



## Aluminum Color Standoffs



# Color Aluminum Standoffs

Affordable! Indoor and Outdoor Signage

**Long Lasting**  
Indoor & Outdoor

**Robust**  
Solid Material

**Aesthetic**  
Elegant Finishes

12 Different Finishes



## Aluminum Color Standoffs

- Units do not include hardware or washers.
- Kits come with 4 standoffs, mounting hardware and instruction guide.
- \*Washers not included.



Standoff Head Diameter A	Material Thickness Accepted B	Standoff Barrel Height C	Material Hole Diameter D	Silver (SL)	Silver Kits (SL)	Silver Head Replacement (SL)
1/2"	1/8" to 5/16"	1/2"	3/8"	AS12-12SL	AS12-12SL-KIT	AS12-12SL-HEAD
	1/8" to 1/2"	3/4"		AS12-25SL	AS12-25SL-KIT	AS12-SL-HEAD
	0 to 1/2"	1"		AS12-30SL	AS12-30SL-KIT	
	0 to 1/2"	1-1/2"		AS12-38SL	AS12-38SL-KIT	
5/8"	0 to 1/2"	2"	7/16"	AS12-50SL	AS12-50SL-KIT	AS16-SL-HEAD
	1/8" to 5/16"	1/2"		AS16-12SL	AS16-12SL-KIT	
	1/8" to 1/2"	3/4"		AS16-25SL	AS16-25SL-KIT	
	0 to 1/2"	1"		AS16-30SL	AS16-30SL-KIT	
3/4"	0 to 1/2"	1-1/2"	7/16"	AS16-38SL	AS16-38SL-KIT	AS19-SL-HEAD
	0 to 1/2"	2"		AS16-50SL	AS16-50SL-KIT	
	1/8" to 5/16"	1/2"		AS19-12SL	AS19-12SL-KIT	
	1/8" to 1/2"	3/4"		AS19-25SL	AS19-25SL-KIT	
1"	0 to 1/2"	1"	7/16"	AS19-30SL	AS19-30SL-KIT	AS25-SL-HEAD
	0 to 1/2"	1-1/2"		AS19-38SL	AS19-38SL-KIT	
	0 to 1/2"	2"		AS19-50SL	AS19-50SL-KIT	
	1/8" to 5/16"	1/2"		AS25-12SL	AS25-12SL-KIT	
1-1/4"	1/8" to 1/2"	3/4"	7/16"	AS25-25SL	AS25-25SL-KIT	AS30-SL-HEAD
	0 to 1/2"	1"		AS25-30SL	AS25-30SL-KIT	
	0 to 1/2"	1-1/2"		AS25-38SL	AS25-38SL-KIT	
	0 to 1/2"	2"		AS25-50SL	AS25-50SL-KIT	
2"	1/8" to 5/16"	1/2"	7/16"	AS30-12SL	AS30-12SL-KIT	AS50-SL-HEAD
	1/8" to 1/2"	3/4"		AS30-25SL	AS30-25SL-KIT	
	0 to 1/2"	1"		AS30-30SL	AS30-30SL-KIT	
	0 to 1/2"	1-1/2"		AS30-38SL	AS30-38SL-KIT	
	0 to 1/2"	2"		AS30-50SL	AS30-50SL-KIT	
	1/8" to 5/16"	1/2"		AS50-12SL	AS50-12SL-KIT	
	1/8" to 1/2"	3/4"		AS50-25SL	AS50-25SL-KIT	
	0 to 1/2"	1"		AS50-30SL	AS50-30SL-KIT	
	0 to 1/2"	1-1/2"		AS50-38SL	AS50-38SL-KIT	
	0 to 1/2"	2"		AS50-50SL	AS50-50SL-KIT	

1/2" & 5/8" Diameter: Use for drywall: screw 2208 and anchor ANC5, ANC5Z. Use for concrete: screw 2208 and anchor ANC1  
 3/4" to 2" Diameter: Use for drywall: screw 2216 and anchor ANC6, ANC6Z. Use for concrete: screw 2216 and anchor ANC2

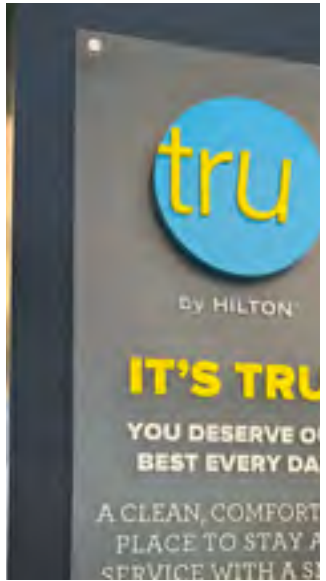

### Standoff Selection Guide

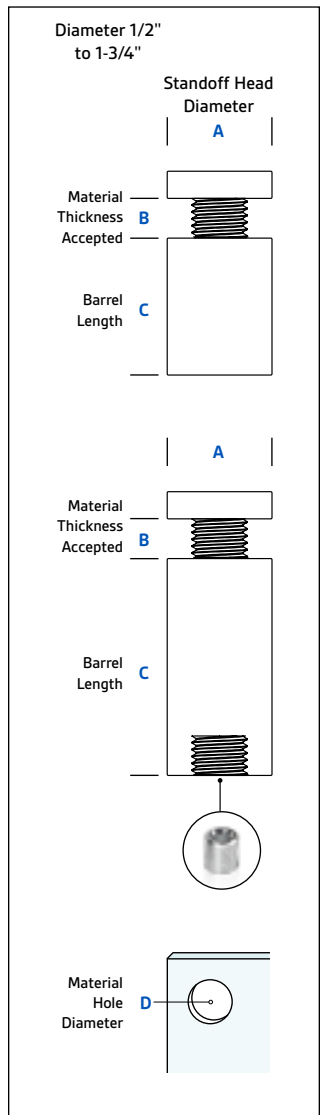

## Aluminum Color Standoffs

- **Units** do not include hardware or washers.
- **Kits** come with 4 standoffs, mounting hardware and instruction guide.
- \*Washers not included.



Standoff Head Diameter A	Material Thickness Accepted B	Standoff Barrel Height C	Material Hole Diameter D	Black (BK)	Black Kits (BK)	Black Head Replacement (BK)	Blue (BL)	Blue Kits (BL)	Blue Head Replacement (BL)
1/2"	1/8" to 5/16"	1/2"	3/8"	AS12-12BK	AS12-12BK-KIT	AS12-12BK-HEAD	AS12-12BL	AS12-12BL-KIT	AS12-12BL-HEAD
	1/8" to 1/2"	3/4"		AS12-25BK	AS12-25BK-KIT	AS12-BK-HEAD	AS12-25BL	AS12-25BL-KIT	AS12-BL-HEAD
	0 to 1/2"	1"		AS12-30BK	AS12-30BK-KIT		AS12-30BL	AS12-30BL-KIT	
	0 to 1/2"	1-1/2"		AS12-38BK	AS12-38BK-KIT		AS12-38BL	AS12-38BL-KIT	
	0 to 1/2"	2"	AS12-50BK	AS12-50BK-KIT		AS12-50BL	AS12-50BL-KIT		
5/8"	1/8" to 5/16"	1/2"	7/16"	AS16-12BK	AS16-12BK-KIT	AS16-12BK-HEAD	AS16-12BL	AS16-12BL-KIT	AS16-12BL-HEAD
	1/8" to 1/2"	3/4"		AS16-25BK	AS16-25BK-KIT	AS16-BK-HEAD	AS16-25BL	AS16-25BL-KIT	AS16-BL-HEAD
	0 to 1/2"	1"		AS16-30BK	AS16-30BK-KIT		AS16-30BL	AS16-30BL-KIT	
	0 to 1/2"	1-1/2"		AS16-38BK	AS16-38BK-KIT		AS16-38BL	AS16-38BL-KIT	
	0 to 1/2"	2"	AS16-50BK	AS16-50BK-KIT		AS16-50BL	AS16-50BL-KIT		
3/4"	1/8" to 5/16"	1/2"	7/16"	AS19-12BK	AS19-12BK-KIT	AS19-12BK-HEAD	AS19-12BL	AS19-12BL-KIT	AS19-12BL-HEAD
	1/8" to 1/2"	3/4"		AS19-25BK	AS19-25BK-KIT	AS19-BK-HEAD	AS19-25BL	AS19-25BL-KIT	AS19-BL-HEAD
	0 to 1/2"	1"		AS19-30BK	AS19-30BK-KIT		AS19-30BL	AS19-30BL-KIT	
	0 to 1/2"	1-1/2"		AS19-38BK	AS19-38BK-KIT		AS19-38BL	AS19-38BL-KIT	
	0 to 1/2"	2"	AS19-50BK	AS19-50BK-KIT		AS19-50BL	AS19-50BL-KIT		
1"	1/8" to 5/16"	1/2"	7/16"	AS25-12BK	AS25-12BK-KIT	AS25-12BK-HEAD	AS25-12BL	AS25-12BL-KIT	AS25-12BL-HEAD
	1/8" to 1/2"	3/4"		AS25-25BK	AS25-25BK-KIT	AS25-BK-HEAD	AS25-25BL	AS25-25BL-KIT	AS25-BL-HEAD
	0 to 1/2"	1"		AS25-30BK	AS25-30BK-KIT		AS25-30BL	AS25-30BL-KIT	
	0 to 1/2"	1-1/2"		AS25-38BK	AS25-38BK-KIT		AS25-38BL	AS25-38BL-KIT	
	0 to 1/2"	2"	AS25-50BK	AS25-50BK-KIT		AS25-50BL	AS25-50BL-KIT		
1-1/4"	1/8" to 5/16"	1/2"	7/16"	AS30-12BK	AS30-12BK-KIT	AS30-12BK-HEAD	AS30-12BL	AS30-12BL-KIT	AS30-12BL-HEAD
	1/8" to 1/2"	3/4"		AS30-25BK	AS30-25BK-KIT	AS30-BK-HEAD	AS30-25BL	AS30-25BL-KIT	AS30-BL-HEAD
	0 to 1/2"	1"		AS30-30BK	AS30-30BK-KIT		AS30-30BL	AS30-30BL-KIT	
	0 to 1/2"	1-1/2"		AS30-38BK	AS30-38BK-KIT		AS30-38BL	AS30-38BL-KIT	
	0 to 1/2"	2"	AS30-50BK	AS30-50BK-KIT		AS30-50BL	AS30-50BL-KIT		
2"	1/8" to 5/16"	1/2"	7/16"	AS50-12BK	AS50-12BK-KIT	AS50-12BK-HEAD	AS50-12BL	AS50-12BL-KIT	AS50-12BL-HEAD
	1/8" to 1/2"	3/4"		AS50-25BK	AS50-25BK-KIT	AS50-BK-HEAD	AS50-25BL	AS50-25BL-KIT	AS50-BL-HEAD
	0 to 1/2"	1"		AS50-30BK	AS50-30BK-KIT		AS50-30BL	AS50-30BL-KIT	
	0 to 1/2"	1-1/2"		AS50-38BK	AS50-38BK-KIT		AS50-38BL	AS50-38BL-KIT	
	0 to 1/2"	2"	AS50-50BK	AS50-50BK-KIT		AS50-50BL	AS50-50BL-KIT		

1/2" & 5/8" Diameter: Use for drywall: screw 2208 and anchor ANC5, ANC5Z. Use for concrete: screw 2208 and anchor ANC1  
 3/4" to 2" Diameter: Use for drywall: screw 2216 and anchor ANC6, ANC6Z. Use for concrete: screw 2216 and anchor ANC2

## Aluminum Color Standoffs



Standoff Head Diameter A	Material Thickness Accepted B	Standoff Barrel Height C	Material Hole Diameter D	Champagne (BR)	Champagne Kits (BR)	Champagne Head Replacement (BR)	Copper (CP)	Copper Kits (CP)	Copper Head Replacement (CP)
1/2"	1/8" to 5/16"	1/2"	3/8"	AS12-12BR	AS12-12BR-KIT	AS12-12BR-HEAD	AS12-12CP	AS12-12CP-KIT	AS12-12CP-HEAD
	1/8" to 1/2"	3/4"		AS12-25BR	AS12-25BR-KIT	AS12-BR-HEAD	AS12-25CP	AS12-25CP-KIT	AS12-CP-HEAD
	0 to 1/2"	1"		AS12-30BR	AS12-30BR-KIT		AS12-30CP	AS12-30CP-KIT	
	0 to 1/2"	1-1/2"		AS12-38BR	AS12-38BR-KIT		AS12-38CP	AS12-38CP-KIT	
	0 to 1/2"	2"	AS12-50BR	AS12-50BR-KIT		AS12-50CP	AS12-50CP-KIT		
5/8"	1/8" to 5/16"	1/2"	7/16"	AS16-12BR	AS16-12BR-KIT	AS16-12BR-HEAD	AS16-12CP	AS16-12CP-KIT	AS16-12CP-HEAD
	1/8" to 1/2"	3/4"		AS16-25BR	AS16-25BR-KIT	AS16-BR-HEAD	AS16-25CP	AS16-25CP-KIT	AS16-CP-HEAD
	0 to 1/2"	1"		AS16-30BR	AS16-30BR-KIT		AS16-30CP	AS16-30CP-KIT	
	0 to 1/2"	1-1/2"		AS16-38BR	AS16-38BR-KIT		AS16-38CP	AS16-38CP-KIT	
	0 to 1/2"	2"	AS16-50BR	AS16-50BR-KIT		AS16-50CP	AS16-50CP-KIT		
3/4"	1/8" to 5/16"	1/2"	7/16"	AS19-12BR	AS19-12BR-KIT	AS19-12BR-HEAD	AS19-12CP	AS19-12CP-KIT	AS19-12CP-HEAD
	1/8" to 1/2"	3/4"		AS19-25BR	AS19-25BR-KIT	AS19-BR-HEAD	AS19-25CP	AS19-25CP-KIT	AS19-CP-HEAD
	0 to 1/2"	1"		AS19-30BR	AS19-30BR-KIT		AS19-30CP	AS19-30CP-KIT	
	0 to 1/2"	1-1/2"		AS19-38BR	AS19-38BR-KIT		AS19-38CP	AS19-38CP-KIT	
	0 to 1/2"	2"	AS19-50BR	AS19-50BR-KIT		AS19-50CP	AS19-50CP-KIT		
1"	1/8" to 5/16"	1/2"	7/16"	AS25-12BR	AS25-12BR-KIT	AS25-12BR-HEAD	AS25-12CP	AS25-12CP-KIT	AS25-12CP-HEAD
	1/8" to 1/2"	3/4"		AS25-25BR	AS25-25BR-KIT	AS25-BR-HEAD	AS25-25CP	AS25-25CP-KIT	AS25-CP-HEAD
	0 to 1/2"	1"		AS25-30BR	AS25-30BR-KIT		AS25-30CP	AS25-30CP-KIT	
	0 to 1/2"	1-1/2"		AS25-38BR	AS25-38BR-KIT		AS25-38CP	AS25-38CP-KIT	
	0 to 1/2"	2"	AS25-50BR	AS25-50BR-KIT		AS25-50CP	AS25-50CP-KIT		
1-1/4"	1/8" to 5/16"	1/2"	7/16"	AS30-12BR	AS30-12BR-KIT	AS30-12BR-HEAD	AS30-12CP	AS30-12CP-KIT	AS30-12CP-HEAD
	1/8" to 1/2"	3/4"		AS30-25BR	AS30-25BR-KIT	AS30-BR-HEAD	AS30-25CP	AS30-25CP-KIT	AS30-CP-HEAD
	0 to 1/2"	1"		AS30-30BR	AS30-30BR-KIT		AS30-30CP	AS30-30CP-KIT	
	0 to 1/2"	1-1/2"		AS30-38BR	AS30-38BR-KIT		AS30-38CP	AS30-38CP-KIT	
	0 to 1/2"	2"	AS30-50BR	AS30-50BR-KIT		AS30-50CP	AS30-50CP-KIT		
2"	1/8" to 5/16"	1/2"	7/16"	AS50-12BR	AS50-12BR-KIT	AS50-12BR-HEAD	AS50-12CP	AS50-12CP-KIT	AS50-12CP-HEAD
	1/8" to 1/2"	3/4"		AS50-25BR	AS50-25BR-KIT	AS50-BR-HEAD	AS50-25CP	AS50-25CP-KIT	AS50-CP-HEAD
	0 to 1/2"	1"		AS50-30BR	AS50-30BR-KIT		AS50-30CP	AS50-30CP-KIT	
	0 to 1/2"	1-1/2"		AS50-38BR	AS50-38BR-KIT		AS50-38CP	AS50-38CP-KIT	
	0 to 1/2"	2"	AS50-50BR	AS50-50BR-KIT		AS50-50CP	AS50-50CP-KIT		

1/2" & 5/8" Diameter: Use for drywall: screw 2208 and anchor ANC5, ANC5Z. Use for concrete: screw 2208 and anchor ANC1  
 3/4" to 2" Diameter: Use for drywall: screw 2216 and anchor ANC6, ANC6Z. Use for concrete: screw 2216 and anchor ANC2

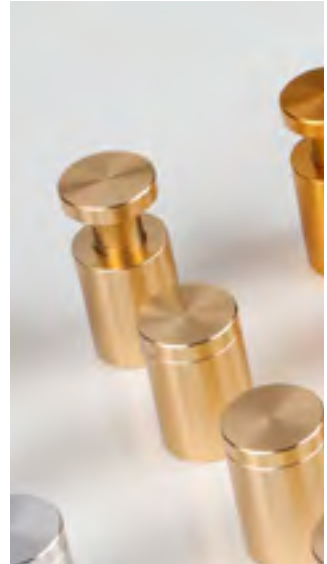

### Standoff Selection Guide

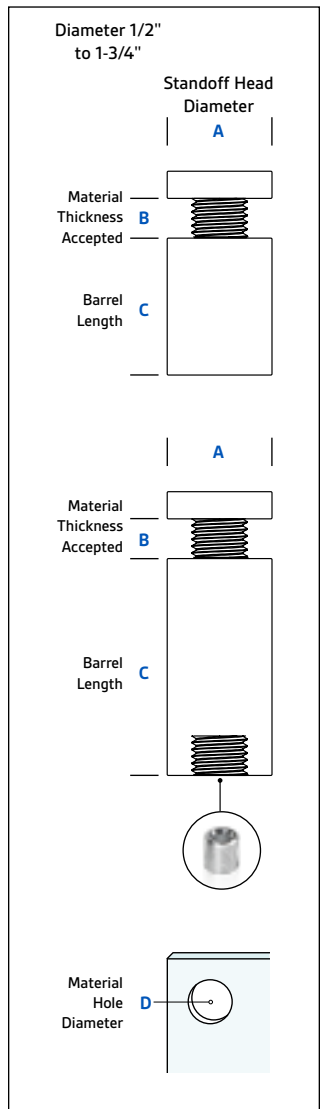



## Aluminum Color Standoffs

- **Units** do not include hardware or washers.
- **Kits** come with 4 standoffs, mounting hardware and instruction guide.
- \*Washers not included.



Standoff Head Diameter A	Material Thickness Accepted B	Standoff Barrel Height C	Material Hole Diameter D	Gold (GN)	Gold Kits (GN)	Gold Head Replacement (GN)	Green (GN)	Green Kits (GN)	Green Head Replacement (GN)
1/2"	1/8" to 5/16"	1/2"	3/8"	AS12-12GD	AS12-12GD-KIT	AS12-12GD-HEAD	AS12-12GN	AS12-12GN-KIT	AS12-12GN-HEAD
	1/8" to 1/2"	3/4"		AS12-25GD	AS12-25GD-KIT	AS12-25GN	AS12-25GN-KIT	AS12-25GN-HEAD	
	0 to 1/2"	1"		AS12-30GD	AS12-30GD-KIT	AS12-30GN	AS12-30GN-KIT	AS12-GD-HEAD	AS12-GN-HEAD
	0 to 1/2"	1-1/2"		AS12-38GD	AS12-38GD-KIT	AS12-38GN	AS12-38GN-KIT	AS12-38GD-HEAD	AS12-38GN-HEAD
	0 to 1/2"	2"		AS12-50GD	AS12-50GD-KIT	AS12-50GN	AS12-50GN-KIT	AS12-50GD-HEAD	AS12-50GN-HEAD
5/8"	1/8" to 5/16"	1/2"	7/16"	AS16-12GD	AS16-12GD-KIT	AS16-12GD-HEAD	AS16-12GN	AS16-12GN-KIT	AS16-12GN-HEAD
	1/8" to 1/2"	3/4"		AS16-25GD	AS16-25GD-KIT	AS16-25GN	AS16-25GN-KIT	AS16-25GD-HEAD	AS16-25GN-HEAD
	0 to 1/2"	1"		AS16-30GD	AS16-30GD-KIT	AS16-30GN	AS16-30GN-KIT	AS16-GD-HEAD	AS16-GN-HEAD
	0 to 1/2"	1-1/2"		AS16-38GD	AS16-38GD-KIT	AS16-38GN	AS16-38GN-KIT	AS16-38GD-HEAD	AS16-38GN-HEAD
	0 to 1/2"	2"		AS16-50GD	AS16-50GD-KIT	AS16-50GN	AS16-50GN-KIT	AS16-50GD-HEAD	AS16-50GN-HEAD
3/4"	1/8" to 5/16"	1/2"	7/16"	AS19-12GD	AS19-12GD-KIT	AS19-12GD-HEAD	AS19-12GN	AS19-12GN-KIT	AS19-12GN-HEAD
	1/8" to 1/2"	3/4"		AS19-25GD	AS19-25GD-KIT	AS19-25GN	AS19-25GN-KIT	AS19-25GD-HEAD	AS19-25GN-HEAD
	0 to 1/2"	1"		AS19-30GD	AS19-30GD-KIT	AS19-30GN	AS19-30GN-KIT	AS19-GD-HEAD	AS19-GN-HEAD
	0 to 1/2"	1-1/2"		AS19-38GD	AS19-38GD-KIT	AS19-38GN	AS19-38GN-KIT	AS19-38GD-HEAD	AS19-38GN-HEAD
	0 to 1/2"	2"		AS19-50GD	AS19-50GD-KIT	AS19-50GN	AS19-50GN-KIT	AS19-50GD-HEAD	AS19-50GN-HEAD
1"	1/8" to 5/16"	1/2"	7/16"	AS25-12GD	AS25-12GD-KIT	AS25-12GD-HEAD	AS25-12GN	AS25-12GN-KIT	AS25-12GN-HEAD
	1/8" to 1/2"	3/4"		AS25-25GD	AS25-25GD-KIT	AS25-25GN	AS25-25GN-KIT	AS25-25GD-HEAD	AS25-25GN-HEAD
	0 to 1/2"	1"		AS25-30GD	AS25-30GD-KIT	AS25-30GN	AS25-30GN-KIT	AS25-GD-HEAD	AS25-GN-HEAD
	0 to 1/2"	1-1/2"		AS25-38GD	AS25-38GD-KIT	AS25-38GN	AS25-38GN-KIT	AS25-38GD-HEAD	AS25-38GN-HEAD
	0 to 1/2"	2"		AS25-50GD	AS25-50GD-KIT	AS25-50GN	AS25-50GN-KIT	AS25-50GD-HEAD	AS25-50GN-HEAD
1-1/4"	1/8" to 5/16"	1/2"	7/16"	AS30-12GD	AS30-12GD-KIT	AS30-12GD-HEAD	AS30-12GN	AS30-12GN-KIT	AS30-12GN-HEAD
	1/8" to 1/2"	3/4"		AS30-25GD	AS30-25GD-KIT	AS30-25GN	AS30-25GN-KIT	AS30-25GD-HEAD	AS30-25GN-HEAD
	0 to 1/2"	1"		AS30-30GD	AS30-30GD-KIT	AS30-30GN	AS30-30GN-KIT	AS30-GD-HEAD	AS30-GN-HEAD
	0 to 1/2"	1-1/2"		AS30-38GD	AS30-38GD-KIT	AS30-38GN	AS30-38GN-KIT	AS30-38GD-HEAD	AS30-38GN-HEAD
	0 to 1/2"	2"		AS30-50GD	AS30-50GD-KIT	AS30-50GN	AS30-50GN-KIT	AS30-50GD-HEAD	AS30-50GN-HEAD
2"	1/8" to 5/16"	1/2"	7/16"	AS50-12GD	AS50-12GD-KIT	AS50-12GD-HEAD	AS50-12GN	AS50-12GN-KIT	AS50-12GN-HEAD
	1/8" to 1/2"	3/4"		AS50-25GD	AS50-25GD-KIT	AS50-25GN	AS50-25GN-KIT	AS50-25GD-HEAD	AS50-25GN-HEAD
	0 to 1/2"	1"		AS50-30GD	AS50-30GD-KIT	AS50-30GN	AS50-30GN-KIT	AS50-GD-HEAD	AS50-GN-HEAD
	0 to 1/2"	1-1/2"		AS50-38GD	AS50-38GD-KIT	AS50-38GN	AS50-38GN-KIT	AS50-38GD-HEAD	AS50-38GN-HEAD
	0 to 1/2"	2"		AS50-50GD	AS50-50GD-KIT	AS50-50GN	AS50-50GN-KIT	AS50-50GD-HEAD	AS50-50GN-HEAD

1/2" & 5/8" Diameter: Use for drywall: screw 2208 and anchor ANC5, ANC5Z. Use for concrete: screw 2208 and anchor ANC1  
 3/4" to 2" Diameter: Use for drywall: screw 2216 and anchor ANC6, ANC6Z. Use for concrete: screw 2216 and anchor ANC2

## Aluminum Color Standoffs



Purple (PL)	Purple Kits (PL)	Purple Head Replacement (PL)	Cherry Red (RD)	Cherry Red Kits (RD)	Cherry Red Head Replacement (RD)
AS12-12PL	AS12-12PL-KIT	AS12-12PL-HEAD	AS12-12RD	AS12-12RD-KIT	AS12-12RD-HEAD
AS12-25PL	AS12-25PL-KIT	AS12-25PL-HEAD	AS12-25RD	AS12-25RD-KIT	AS12-25RD-HEAD
AS12-30PL	AS12-30PL-KIT	AS12-PL-HEAD	AS12-30RD	AS12-30RD-KIT	AS12-RD-HEAD
AS12-38PL	AS12-38PL-KIT	AS12-38RD	AS12-38RD-KIT	AS12-38RD-HEAD	
AS12-50PL	AS12-50PL-KIT	AS12-50RD	AS12-50RD-KIT	AS12-50RD-HEAD	
AS16-12PL	AS16-12PL-KIT	AS16-12PL-HEAD	AS16-12RD	AS16-12RD-KIT	AS16-12RD-HEAD
AS16-25PL	AS16-25PL-KIT	AS16-25RD	AS16-25RD-KIT	AS16-25RD-HEAD	
AS16-30PL	AS16-30PL-KIT	AS16-PL-HEAD	AS16-30RD	AS16-30RD-KIT	AS16-RD-HEAD
AS16-38PL	AS16-38PL-KIT	AS16-38RD	AS16-38RD-KIT	AS16-38RD-HEAD	
AS16-50PL	AS16-50PL-KIT	AS16-50RD	AS16-50RD-KIT	AS16-50RD-HEAD	
AS19-12PL	AS19-12PL-KIT	AS19-12PL-HEAD	AS19-12RD	AS19-12RD-KIT	AS19-12RD-HEAD
AS19-25PL	AS19-25PL-KIT	AS19-25RD	AS19-25RD-KIT	AS19-25RD-HEAD	
AS19-30PL	AS19-30PL-KIT	AS19-PL-HEAD	AS19-30RD	AS19-30RD-KIT	AS19-RD-HEAD
AS19-38PL	AS19-38PL-KIT	AS19-38RD	AS19-38RD-KIT	AS19-38RD-HEAD	
AS19-50PL	AS19-50PL-KIT	AS19-50RD	AS19-50RD-KIT	AS19-50RD-HEAD	
AS25-12PL	AS25-12PL-KIT	AS25-12PL-HEAD	AS25-12RD	AS25-12RD-KIT	AS25-12RD-HEAD
AS25-25PL	AS25-25PL-KIT	AS25-25RD	AS25-25RD-KIT	AS25-25RD-HEAD	
AS25-30PL	AS25-30PL-KIT	AS25-PL-HEAD	AS25-30RD	AS25-30RD-KIT	AS25-RD-HEAD
AS25-38PL	AS25-38PL-KIT	AS25-38RD	AS25-38RD-KIT	AS25-38RD-HEAD	
AS25-50PL	AS25-50PL-KIT	AS25-50RD	AS25-50RD-KIT	AS25-50RD-HEAD	
AS30-12PL	AS30-12PL-KIT	AS30-12PL-HEAD	AS30-12RD	AS30-12RD-KIT	AS30-12RD-HEAD
AS30-25PL	AS30-25PL-KIT	AS30-25RD	AS30-25RD-KIT	AS30-25RD-HEAD	
AS30-30PL	AS30-30PL-KIT	AS30-PL-HEAD	AS30-30RD	AS30-30RD-KIT	AS30-RD-HEAD
AS30-38PL	AS30-38PL-KIT	AS30-38RD	AS30-38RD-KIT	AS30-38RD-HEAD	
AS30-50PL	AS30-50PL-KIT	AS30-50RD	AS30-50RD-KIT	AS30-50RD-HEAD	
AS50-12PL	AS50-12PL-KIT	AS50-12PL-HEAD	AS50-12RD	AS50-12RD-KIT	AS50-12RD-HEAD
AS50-25PL	AS50-25PL-KIT	AS50-25RD	AS50-25RD-KIT	AS50-25RD-HEAD	
AS50-30PL	AS50-30PL-KIT	AS50-PL-HEAD	AS50-30RD	AS50-30RD-KIT	AS50-RD-HEAD
AS50-38PL	AS50-38PL-KIT	AS50-38RD	AS50-38RD-KIT	AS50-38RD-HEAD	
AS50-50PL	AS50-50PL-KIT	AS50-50RD	AS50-50RD-KIT	AS50-50RD-HEAD	

1/2" & 5/8" Diameter: Use for drywall: screw 2208 and anchor ANC5, ANC5Z. Use for concrete: screw 2208 and anchor ANC1  
 3/4" to 2" Diameter: Use for drywall: screw 2216 and anchor ANC6, ANC6Z. Use for concrete: screw 2216 and anchor ANC2



### Standoff Selection Guide

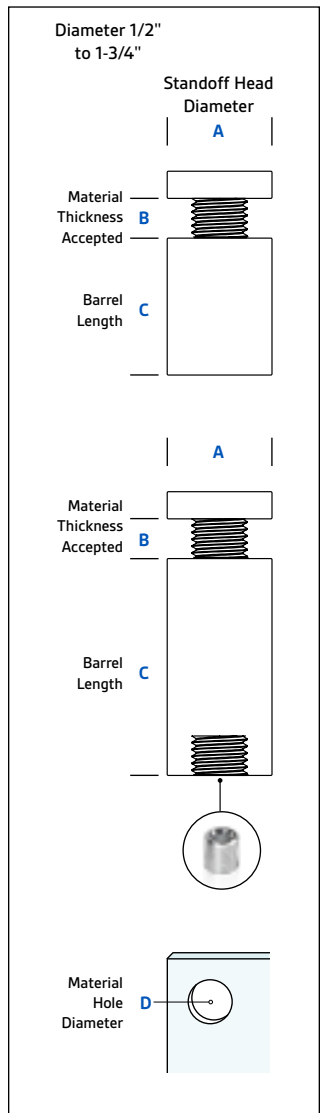

## Aluminum Color Standoffs

- Units do not include hardware or washers.
- Kits come with 4 standoffs, mounting hardware and instruction guide.
- \*Washers not included



Standoff Head Diameter A	Material Thickness Accepted B	Standoff Barrel Height C	Material Hole Diameter D	Rosy Pink (RP)	Rosy Pink Kits (RP)	Rosy Pink Head Replacement (RP)	Steel Grey (SG)	Steel Grey Kits (SG)	Steel Grey Head Replacement (SG)	
1/2"	1/8" to 5/16"	1/2"		AS12-12RP	AS12-12RP-KIT	AS12-12RP-HEAD	AS12-12SG	AS12-12SG-KIT	AS12-12SG-HEAD	
	1/8" to 1/2"	3/4"		AS12-25RP	AS12-25RP-KIT		AS12-25SG	AS12-25SG-KIT		
	0 to 1/2"	1"	3/8"	AS12-30RP	AS12-30RP-KIT	AS12-RP-HEAD	AS12-30SG	AS12-30SG-KIT	AS12-SG-HEAD	
	0 to 1/2"	1-1/2"		AS12-38RP	AS12-38RP-KIT			AS12-38SG		AS12-38SG-KIT
	0 to 1/2"	2"		AS12-50RP	AS12-50RP-KIT			AS12-50SG		AS12-50SG-KIT
5/8"	1/8" to 5/16"	1/2"		AS16-12RP	AS16-12RP-KIT	AS16-12RP-HEAD	AS16-12SG	AS16-12SG-KIT	AS16-12SG-HEAD	
	1/8" to 1/2"	3/4"		AS16-25RP	AS16-25RP-KIT		AS16-25SG	AS16-25SG-KIT		
	0 to 1/2"	1"	7/16"	AS16-30RP	AS16-30RP-KIT	AS16-RP-HEAD	AS16-30SG	AS16-30SG-KIT	AS16-SG-HEAD	
	0 to 1/2"	1-1/2"		AS16-38RP	AS16-38RP-KIT			AS16-38SG		AS16-38SG-KIT
	0 to 1/2"	2"		AS16-50RP	AS16-50RP-KIT			AS16-50SG		AS16-50SG-KIT
3/4"	1/8" to 5/16"	1/2"		AS19-12RP	AS19-12RP-KIT	AS19-12RP-HEAD	AS19-12SG	AS19-12SG-KIT	AS19-12SG-HEAD	
	1/8" to 1/2"	3/4"		AS19-25RP	AS19-25RP-KIT		AS19-25SG	AS19-25SG-KIT		
	0 to 1/2"	1"	7/16"	AS19-30RP	AS19-30RP-KIT	AS19-RP-HEAD	AS19-30SG	AS19-30SG-KIT	AS19-SG-HEAD	
	0 to 1/2"	1-1/2"		AS19-38RP	AS19-38RP-KIT			AS19-38SG		AS19-38SG-KIT
	0 to 1/2"	2"		AS19-50RP	AS19-50RP-KIT			AS19-50SG		AS19-50SG-KIT
1"	1/8" to 5/16"	1/2"		AS25-12RP	AS25-12RP-KIT	AS25-12RP-HEAD	AS25-12SG	AS25-12SG-KIT	AS25-12SG-HEAD	
	1/8" to 1/2"	3/4"		AS25-25RP	AS25-25RP-KIT		AS25-25SG	AS25-25SG-KIT		
	0 to 1/2"	1"	7/16"	AS25-30RP	AS25-30RP-KIT	AS25-RP-HEAD	AS25-30SG	AS25-30SG-KIT	AS25-SG-HEAD	
	0 to 1/2"	1-1/2"		AS25-38RP	AS25-38RP-KIT			AS25-38SG		AS25-38SG-KIT
	0 to 1/2"	2"		AS25-50RP	AS25-50RP-KIT			AS25-50SG		AS25-50SG-KIT
1-1/4"	1/8" to 5/16"	1/2"		AS30-12RP	AS30-12RP-KIT	AS30-12RP-HEAD	AS30-12SG	AS30-12SG-KIT	AS30-12SG-HEAD	
	1/8" to 1/2"	3/4"		AS30-25RP	AS30-25RP-KIT		AS30-25SG	AS30-25SG-KIT		
	0 to 1/2"	1"	7/16"	AS30-30RP	AS30-30RP-KIT	AS30-RP-HEAD	AS30-30SG	AS30-30SG-KIT	AS30-SG-HEAD	
	0 to 1/2"	1-1/2"		AS30-38RP	AS30-38RP-KIT			AS30-38SG		AS30-38SG-KIT
	0 to 1/2"	2"		AS30-50RP	AS30-50RP-KIT			AS30-50SG		AS30-50SG-KIT
2"	1/8" to 5/16"	1/2"		AS50-12RP	AS50-12RP-KIT	AS50-12RP-HEAD	AS50-12SG	AS50-12SG-KIT	AS50-12SG-HEAD	
	1/8" to 1/2"	3/4"		AS50-25RP	AS50-25RP-KIT		AS50-25SG	AS50-25SG-KIT		
	0 to 1/2"	1"	7/16"	AS50-30RP	AS50-30RP-KIT	AS50-RP-HEAD	AS50-30SG	AS50-30SG-KIT	AS50-SG-HEAD	
	0 to 1/2"	1-1/2"		AS50-38RP	AS50-38RP-KIT			AS50-38SG		AS50-38SG-KIT
	0 to 1/2"	2"		AS50-50RP	AS50-50RP-KIT			AS50-50SG		AS50-50SG-KIT

1/2" & 5/8" Diameter: Use for drywall: screw 2208 and anchor ANC5, ANC5Z. Use for concrete: screw 2208 and anchor ANC1  
 3/4" to 2" Diameter: Use for drywall: screw 2216 and anchor ANC6, ANC6Z. Use for concrete: screw 2216 and anchor ANC2

## Aluminum Color Standoffs



White Coated (WH)	White Coated Kits (WH)	White Coated Head Replacement (WH)
AS12-12WH	AS12-12WH-KIT	AS12-12WH-HEAD
AS12-25WH	AS12-25WH-KIT	
AS12-30WH	AS12-30WH-KIT	AS12-WH-HEAD
AS12-38WH	AS12-38WH-KIT	
AS12-50WH	AS12-50WH-KIT	
AS16-12WH	AS16-12WH-KIT	AS16-12WH-HEAD
AS16-25WH	AS16-25WH-KIT	
AS16-30WH	AS16-30WH-KIT	AS16-WH-HEAD
AS16-38WH	AS16-38WH-KIT	
AS16-50WH	AS16-50WH-KIT	
AS19-12WH	AS19-12WH-KIT	AS19-12WH-HEAD
AS19-25WH	AS19-25WH-KIT	
AS19-30WH	AS19-30WH-KIT	AS19-WH-HEAD
AS19-38WH	AS19-38WH-KIT	
AS19-50WH	AS19-50WH-KIT	
AS25-12WH	AS25-12WH-KIT	AS25-12WH-HEAD
AS25-25WH	AS25-25WH-KIT	
AS25-30WH	AS25-30WH-KIT	AS25-WH-HEAD
AS25-38WH	AS25-38WH-KIT	
AS25-50WH	AS25-50WH-KIT	
AS30-12WH	AS30-12WH-KIT	AS30-12WH-HEAD
AS30-25WH	AS30-25WH-KIT	
AS30-30WH	AS30-30WH-KIT	AS30-WH-HEAD
AS30-38WH	AS30-38WH-KIT	
AS30-50WH	AS30-50WH-KIT	
AS50-12WH	AS50-12WH-KIT	AS50-12WH-HEAD
AS50-25WH	AS50-25WH-KIT	
AS50-30WH	AS50-30WH-KIT	AS50-WH-HEAD
AS50-38WH	AS50-38WH-KIT	
AS50-50WH	AS50-50WH-KIT	

## Color Aluminum Standoffs Kits



### Standoff Selection Guide

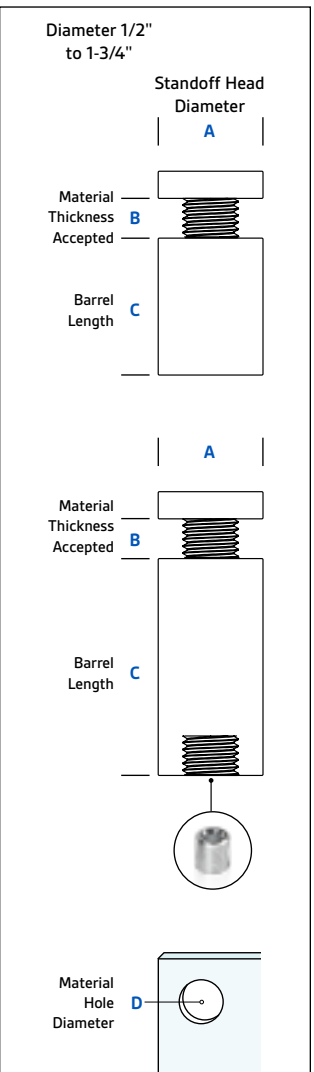



## Acrylic Wall Frame Kits

**Product**

- Heads
- Barrels
- Acrylics
- Screw & Anchors
- Instructions
- Drill Template

**Unique Features**

- Indoor use only
- Wall mounted
- 7 Different Size Acrylics
- 6 Different Finishes

**Area Of Use**

- Signage
- Wayfinder
- Display
- Advertising



## Acrylic Wall Frame Kits

### 1:1 Scale Size Comparison Chart

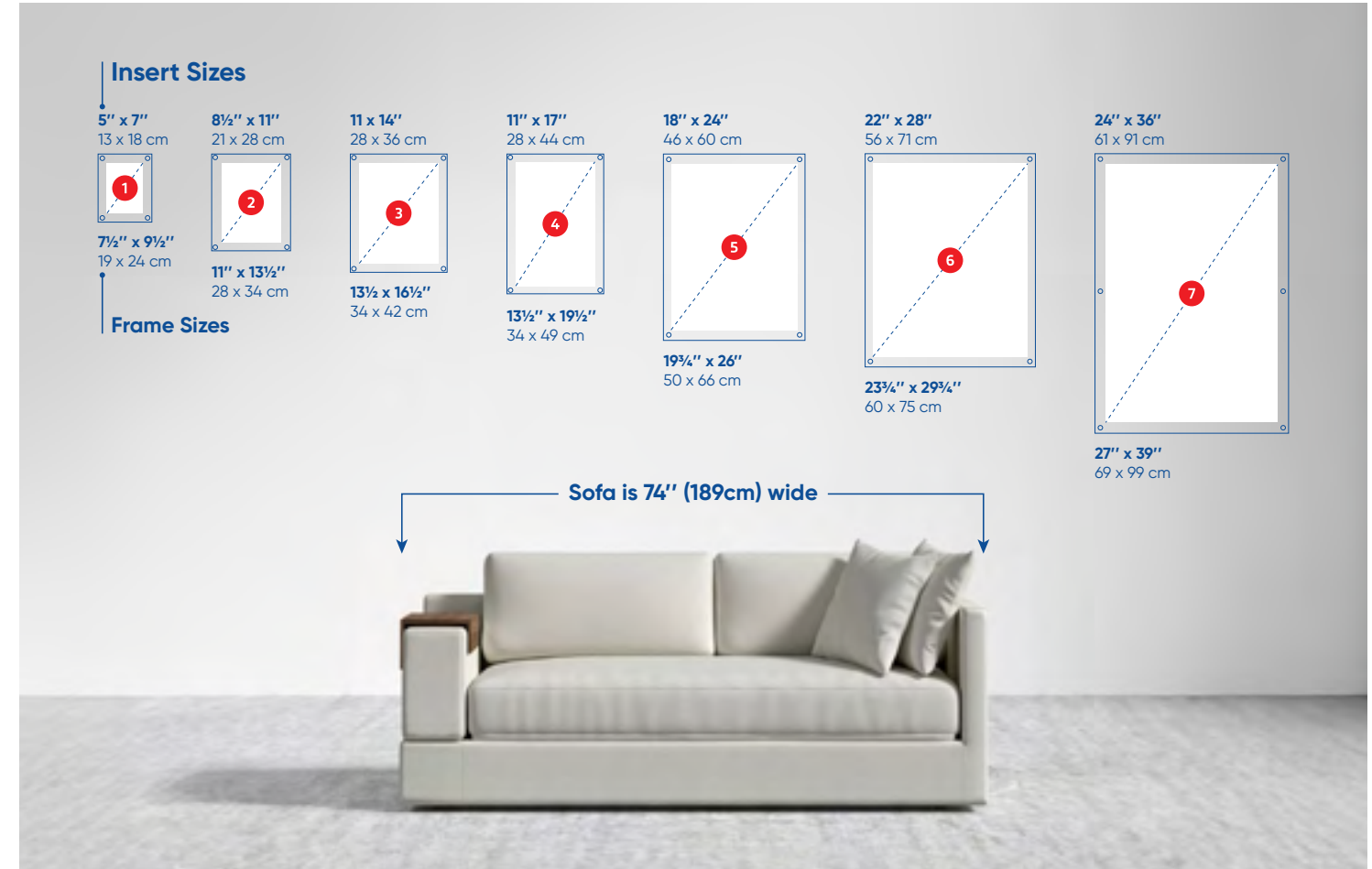

### Drill Template

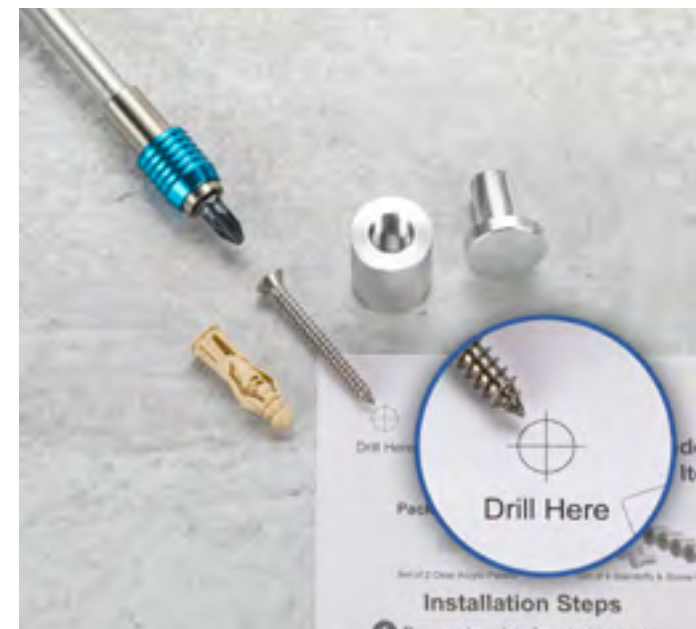

### Installation Guide



## Acrylic Wall Frame Kits

**Kits include**

- 4 or 6 Standoffs depending on size of Acrylic
- 2 Clear Acrylics
- Screws and Anchors
- Drill Template
- Installation Guide

**\* Contact Us For More Standoff Varieties**



#	Insert Size	Frame Size	Standoff Head Diameter	Material Hole Diameter	Aluminum Silver (SL)	Aluminum Black (BK)
1	5" x 7"	7-1/2" x 9-1/2"	5/8"	1/2"	WAC0507-C-AS16-12SL	WAC0507-C-AS16-12BK
			5/8"	3/4"	WAC0507-C-AS16-25SL	WAC0507-C-AS16-25BK
			5/8"	1"	WAC0507-C-AS16-30SL	WAC0507-C-AS16-30BK
2	8.5" x 11"	11" x 13-1/2"	5/8"	1/2"	WAC8511-C-AS16-12SL	WAC8511-C-AS16-12BK
			5/8"	3/4"	WAC8511-C-AS16-25SL	WAC8511-C-AS16-25BK
			5/8"	1"	WAC8511-C-AS16-30SL	WAC8511-C-AS16-30BK
			3/4"	1/2"	WAC8511-C-AS19-12SL	WAC8511-C-AS19-12BK
			3/4"	3/4"	WAC8511-C-AS19-25SL	WAC8511-C-AS19-25BK
			3/4"	1"	WAC8511-C-AS19-30SL	WAC8511-C-AS19-30BK
3	11" x 14"	13-1/2" x 16-1/2"	5/8"	1/2"	WAC1114-C-AS16-12SL	WAC1114-C-AS16-12BK
			5/8"	3/4"	WAC1114-C-AS16-25SL	WAC1114-C-AS16-25BK
			5/8"	1"	WAC1114-C-AS16-30SL	WAC1114-C-AS16-30BK
			3/4"	1/2"	WAC1114-C-AS19-12SL	WAC1114-C-AS19-12BK
			3/4"	3/4"	WAC1114-C-AS19-25SL	WAC1114-C-AS19-25BK
			3/4"	1"	WAC1114-C-AS19-30SL	WAC1114-C-AS19-30BK
4	11" x 17"	13-1/2" x 19-1/2"	5/8"	3/4"	WAC1117-C-AS16-25SL	WAC1117-C-AS16-25BK
			5/8"	1"	WAC1117-C-AS16-30SL	WAC1117-C-AS16-30BK
			3/4"	3/4"	WAC1117-C-AS19-25SL	WAC1117-C-AS19-25BK
			3/4"	1"	WAC1117-C-AS19-30SL	WAC1117-C-AS19-30BK
5	18" x 24"	19-3/4" x 26"	5/8"	3/4"	WAC1824-C-AS16-25SL	WAC1824-C-AS16-25BK
			5/8"	1"	WAC1824-C-AS16-30SL	WAC1824-C-AS16-30BK
			3/4"	3/4"	WAC1824-C-AS19-25SL	WAC1824-C-AS19-25BK
			3/4"	1"	WAC1824-C-AS19-30SL	WAC1824-C-AS19-30BK
6	22" x 28"	23-3/4" x 29-3/4"	5/8"	3/4"	WAC2228-C-AS16-25SL	WAC2228-C-AS16-25BK
			5/8"	1"	WAC2228-C-AS16-30SL	WAC2228-C-AS16-30BK
			3/4"	3/4"	WAC2228-C-AS19-25SL	WAC2228-C-AS19-25BK
			3/4"	1"	WAC2228-C-AS19-30SL	WAC2228-C-AS19-30BK
7	24" x 36"	27" x 39"	5/8"	3/4"	WAC2436-C-AS16-25SL	WAC2436-C-AS16-25BK
			5/8"	1"	WAC2436-C-AS16-30SL	WAC2436-C-AS16-30BK
			3/4"	3/4"	WAC2436-C-AS19-25SL	WAC2436-C-AS19-25BK
			3/4"	1"	WAC2436-C-AS19-30SL	WAC2436-C-AS19-30BK
			1"	3/4"	WAC2436-C-AS25-25SL	WAC2436-C-AS25-25BK
			1"	1"	WAC2436-C-AS25-30SL	WAC2436-C-AS25-30BK

## Acrylic Wall Frame Kits



Aluminum Gold (GD)	Aluminum Champagne (BR)	Stainless Steel Satin Brushed (SBSL)	Stainless Steel Polished (SBLP)
WAC0507-C-AS16-12GD	WAC0507-C-AS16-12BR	WAC0507-C-SBSL16-12	WAC0507-C-SBLP16-12
WAC0507-C-AS16-25GD	WAC0507-C-AS16-25BR	WAC0507-C-SBSL16-25	WAC0507-C-SBLP16-25
WAC0507-C-AS16-30GD	WAC0507-C-AS16-30BR	WAC0507-C-SBSL16-30	WAC0507-C-SBLP16-30
WAC8511-C-AS16-12GD	WAC8511-C-AS16-12BR	WAC8511-C-SBSL16-12	WAC8511-C-SBLP16-12
WAC8511-C-AS16-25GD	WAC8511-C-AS16-25BR	WAC8511-C-SBSL16-25	WAC8511-C-SBLP16-25
WAC8511-C-AS16-30GD	WAC8511-C-AS16-30BR	WAC8511-C-SBSL16-30	WAC8511-C-SBLP16-30
WAC8511-C-AS19-12GD	WAC8511-C-AS19-12BR	WAC8511-C-SBSL19-12	WAC8511-C-SBLP19-12
WAC8511-C-AS19-25GD	WAC8511-C-AS19-25BR	WAC8511-C-SBSL19-25	WAC8511-C-SBLP19-25
WAC8511-C-AS19-30GD	WAC8511-C-AS19-30BR	WAC8511-C-SBSL19-30	WAC8511-C-SBLP19-30
WAC1114-C-AS16-12GD	WAC1114-C-AS16-12BR	WAC1114-C-SBSL16-12	WAC1114-C-SBLP16-12
WAC1114-C-AS16-25GD	WAC1114-C-AS16-25BR	WAC1114-C-SBSL16-25	WAC1114-C-SBLP16-25
WAC1114-C-AS16-30GD	WAC1114-C-AS16-30BR	WAC1114-C-SBSL16-30	WAC1114-C-SBLP16-30
WAC1114-C-AS19-12GD	WAC1114-C-AS19-12BR	WAC1114-C-SBSL19-12	WAC1114-C-SBLP19-12
WAC1114-C-AS19-25GD	WAC1114-C-AS19-25BR	WAC1114-C-SBSL19-25	WAC1114-C-SBLP19-25
WAC1114-C-AS19-30GD	WAC1114-C-AS19-30BR	WAC1114-C-SBSL19-30	WAC1114-C-SBLP19-30
WAC1117-C-AS16-25GD	WAC1117-C-AS16-25BR	WAC1117-C-SBSL16-25	WAC1117-C-SBLP16-25
WAC1117-C-AS16-30GD	WAC1117-C-AS16-30BR	WAC1117-C-SBSL16-30	WAC1117-C-SBLP16-30
WAC1117-C-AS19-25GD	WAC1117-C-AS19-25BR	WAC1117-C-SBSL19-25	WAC1117-C-SBLP19-25
WAC1117-C-AS19-30GD	WAC1117-C-AS19-30BR	WAC1117-C-SBSL19-30	WAC1117-C-SBLP19-30
WAC1824-C-AS16-25GD	WAC1824-C-AS16-25BR	WAC1824-C-SBSL16-25	WAC1824-C-SBLP16-25
WAC1824-C-AS16-30GD	WAC1824-C-AS16-30BR	WAC1824-C-SBSL16-30	WAC1824-C-SBLP16-30
WAC1824-C-AS19-25GD	WAC1824-C-AS19-25BR	WAC1824-C-SBSL19-25	WAC1824-C-SBLP19-25
WAC1824-C-AS19-30GD	WAC1824-C-AS19-30BR	WAC1824-C-SBSL19-30	WAC1824-C-SBLP19-30
WAC2228-C-AS16-25GD	WAC2228-C-AS16-25BR	WAC2228-C-SBSL16-25	WAC2228-C-SBLP16-25
WAC2228-C-AS16-30GD	WAC2228-C-AS16-30BR	WAC2228-C-SBSL16-30	WAC2228-C-SBLP16-30
WAC2228-C-AS19-25GD	WAC2228-C-AS19-25BR	WAC2228-C-SBSL19-25	WAC2228-C-SBLP19-25
WAC2228-C-AS19-30GD	WAC2228-C-AS19-30BR	WAC2228-C-SBSL19-30	WAC2228-C-SBLP19-30
WAC2436-C-AS16-25GD	WAC2436-C-AS16-25BR	WAC2436-C-SBSL16-25	WAC2436-C-SBLP16-25
WAC2436-C-AS16-30GD	WAC2436-C-AS16-30BR	WAC2436-C-SBSL16-30	WAC2436-C-SBLP16-30
WAC2436-C-AS19-25GD	WAC2436-C-AS19-25BR	WAC2436-C-SBSL19-25	WAC2436-C-SBLP19-25
WAC2436-C-AS19-30GD	WAC2436-C-AS19-30BR	WAC2436-C-SBSL19-30	WAC2436-C-SBLP19-30
WAC2436-C-AS25-25GD	WAC2436-C-AS25-25BR	WAC2436-C-SBSL25-25	WAC2436-C-SBLP25-25
WAC2436-C-AS25-30GD	WAC2436-C-AS25-30BR	WAC2436-C-SBSL25-30	WAC2436-C-SBLP25-30



## Wooden Standoffs



# Wooden Standoffs

Real Solid Wood for Indoor Use

Bamboo Matte

Beech Matte

Walnut Matte



3 Different Finishes



## Wooden Standoffs



**NEW**

**All In One Kits!**  
4 x Standoffs  
4 x Screws x Anchors  
1 x Installation Guide



Standoff Head Diameter	Material Thickness Accepted	Standoff Height	Material Hole Diameter	Bamboo Matte (MBO)	Beech Matte (MBE)	Walnut Matte (MWA)
5/8"	1/8" to 3/4"	3/4"	1/4"	WS058-075MBO-KIT	WS058-075MBE-KIT	WS058-075MWA-KIT
		1"	1/4"	WS058-100MBO-KIT	WS058-100MBE-KIT	WS058-100MWA-KIT
3/4"	1/8" to 3/4"	3/4"	1/4"	WS075-075MBO-KIT	WS075-075MBE-KIT	WS075-075MWA-KIT
		1"	1/4"	WS075-100MBO-KIT	WS075-100MBE-KIT	WS075-100MWA-KIT
1"	1/8" to 1/2"	3/4"	1/4"	WS100-075MBO-KIT	WS100-075MBE-KIT	WS100-075MWA-KIT
		1"	1/4"	WS100-100MBO-KIT	WS100-100MBE-KIT	WS100-100MWA-KIT
1-1/4"	1/8" to 1/2"	3/4"	1/4"	WS125-075MBO-KIT	WS125-075MBE-KIT	WS125-075MWA-KIT
		1"	1/4"	WS125-100MBO-KIT	WS125-100MBE-KIT	WS125-100MWA-KIT
1-1/2"	1/8" to 1/2"	3/4"	1/4"	WS150-075MBO-KIT	WS150-075MBE-KIT	WS150-075MWA-KIT
		1"	1/4"	WS150-100MBO-KIT	WS150-100MBE-KIT	WS150-100MWA-KIT
2"	1/8" to 1/2"	3/4"	1/4"	WS200-075MBO-KIT	WS200-075MBE-KIT	WS200-075MWA-KIT
		1"	1/4"	WS200-100MBO-KIT	WS200-100MBE-KIT	WS200-100MWA-KIT

\* Contact us for a interchangeable stud for thinner / thicker material thickness

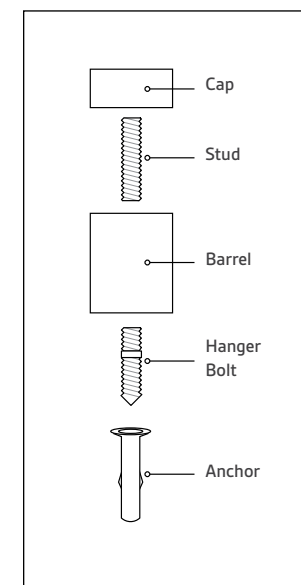

## Brass Standoffs

<b>Product</b>	Heads Washers Barrel
<b>Unique Features</b>	Indoor Use Only Brass Material Wall Mounted 2 Different Heights 3 Different Finishes
<b>Area Of Use</b>	Signage Wayfinder Display Advertising
<b>Additional Details</b>	Tamper Proof Standoffs Non-threaded stud



Standoff Head Diameter A	Material Thickness Accepted B	Standoff Height C	Material Hole Diameter D	Polished Satin Silver (A)	Polished Chrome (AS)	Gold Chrome (GS)
5/8"	0 to 1/2"	7/8"	3/8"	1623A	1623AS	1623GS
7/8"	0 to 9/16"	1"	7/8"	2327A	2327AS	2327GS

Use for drywall: screw 2208 and anchor ANC5, ANC5Z. Use for concrete: screw 2208 and anchor ANC1

## Acrylic Tamper Proof Standoffs

<b>Product</b>	Head Washers Barrel
<b>Unique Features</b>	Indoor & Outdoor Use Wall Mounted 5 Different Heights 4 Different Diameters 2 Different Finishes
<b>Area Of Use</b>	Signage Wayfinder Display Advertising
<b>Additional Details</b>	White Acrylic Standoff is reverse threaded



Standoff Head Diameter	Material Thickness Accepted	Standoff Height	Material Hole Diameter	Acrylic Clear (C)	Acrylic Clear Kit (C)	Acrylic White (W)	Acrylic White Kit (W)
1/2"	0 to 1/4"	1/2"	3/8"	ACS12-12C	ACS12-12C-KIT	ACS12-12W	ACS12-12W-KIT
	0 to 1/2"	3/4"		ACS12-25C	ACS12-25C-KIT	ACS12-25W	ACS12-25W-KIT
	0 to 1/2"	1"		ACS12-30C	ACS12-30C-KIT	ACS12-30W	ACS12-30W-KIT
	0 to 1/2"	1-3/4"		ACS12-50C	ACS12-50C-KIT	ACS12-50W	ACS12-50W-KIT
	0 to 1/2"	2-1/2"		ACS12-70C	ACS12-70C-KIT	N/A	N/A
5/8"	0 to 1/4"	1/2"	7/16"	ACS16-12C	ACS16-12C-KIT	ACS16-12W	ACS16-12W-KIT
	0 to 1/2"	3/4"		ACS16-25C	ACS16-25C-KIT	ACS16-25W	ACS16-25W-KIT
	0 to 1/2"	1"		ACS16-30C	ACS16-30C-KIT	ACS16-30W	ACS16-30W-KIT
	0 to 1/2"	1-3/4"		ACS16-50C	ACS16-50C-KIT	ACS16-50W	ACS16-50W-KIT
	0 to 1/2"	2-1/2"		ACS16-70C	ACS16-70C-KIT	N/A	N/A
3/4"	0 to 1/4"	1/2"	7/16"	ACS19-12C	ACS19-12C-KIT	ACS19-12W	ACS19-12W-KIT
	0 to 1/2"	3/4"		ACS19-25C	ACS19-25C-KIT	ACS19-25W	ACS19-25W-KIT
	0 to 1/2"	1"		ACS19-30C	ACS19-30C-KIT	ACS19-30W	ACS19-30W-KIT
	0 to 1/2"	1-3/4"		ACS19-50C	ACS19-50C-KIT	ACS19-50W	ACS19-50W-KIT
	0 to 1/2"	2-1/2"		ACS19-70C	ACS19-70C-KIT	N/A	N/A
1"	0 to 1/4"	1/2"	7/16"	ACS25-12C	ACS25-12C-KIT	ACS25-12W	ACS25-12W-KIT
	0 to 1/2"	3/4"		ACS25-25C	ACS25-25C-KIT	ACS25-25W	ACS25-25W-KIT
	0 to 1/2"	1"		ACS25-30C	ACS25-30C-KIT	ACS25-30W	ACS25-30W-KIT
	0 to 1/2"	1-3/4"		ACS25-50C	ACS25-50C-KIT	ACS25-50W	ACS25-50W-KIT
	0 to 1/2"	2-1/2"		ACS25-70C	ACS25-70C-KIT	N/A	N/A

1/2" & 5/8" Diameter: Use for drywall: screw 2208 and anchor ANC5, ANC5Z. Use for concrete: screw 2208 and anchor ANC1  
3/4" & 1" Diameter: Use for drywall: screw 2216 and anchor ANC6, ANC6Z. Use for concrete: screw 2216 and anchor ANC2



## Aluminum LED Standoffs

- Product** LED Standoff Hub Transformer 120V
- Unique Features** Indoor Use Only Aluminum Clear Anodized 3 Solid Colors Set of 2 or 4 kits
- Area Of Use** Signage Wayfinder Display Advertising
- Additional Details** Drill a 7/8" hole for best lighting effect. Acrylic and hardware not included.



**LED Standoffs are available in aluminum with a clear anodized finish, offering a selection of color tones in white, blue, and red.**

### Up to 6 LED Standoffs Hub



### Set of 2 or 4 LED Kits

Drill a 7/8" hole for best lighting effect.

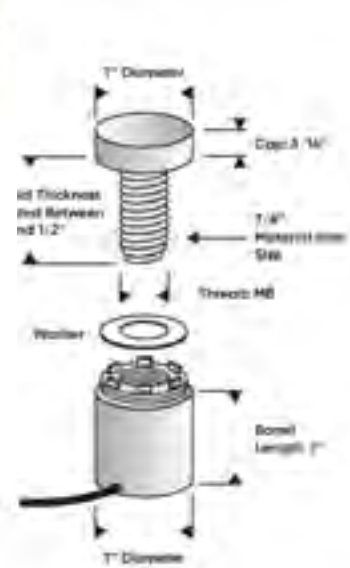

Diameter	Material Thickness Accepted	Height	Required Material Size
1"	1/8" and 1/2"	1"	7/8"

## Aluminum LED Standoffs

- Set of 2 Kits** 2 x LED Standoffs 1 x Hub Connector & Adapter



White LED



LS2W25-25A

Blue LED



LS2B25-25A

Red LED



LS2R25-25A

Use for drywall: screw 2216 and anchor ANC6, ANC6Z. Use for concrete: screw 2216 and anchor ANC2.

- Set of 4 Kits** 4 x LED Standoffs 1 x Hub Connector & Adapter



White LED



LS4W25-25A

Blue LED



LS4B25-25A

Red LED



LS4R25-25A

Use for drywall: screw 2216 and anchor ANC6, ANC6Z. Use for concrete: screw 2216 and anchor ANC2.

## Desktop Standoffs

<b>Product</b>	Head Washers Barrel
<b>Unique Features</b>	Indoor Counter Spaces Tabletops 4 Different Finishes 3 Different Sizes
<b>Area Of Use</b>	Trade Shows Retail Shops Offices Hospital
<b>Additional Details</b>	Beautiful look for any office, business, or professional setting.



## Desktop Standoffs

<b>Product</b>	Head Washers Barrel
<b>Unique Features</b>	Indoor Counter Spaces Tabletops 7 Different Finishes
<b>Area Of Use</b>	Trade Shows Retail Shops Offices Hospital
<b>Additional Details</b>	Beautiful look for any office, business, or professional setting



### 60° Angle Desktop Standoffs

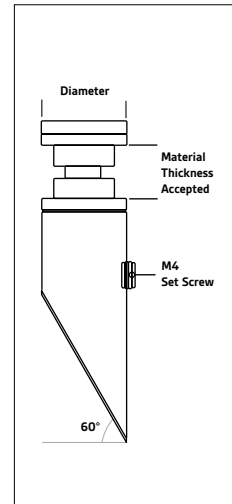

Diameter	Length	Material Thickness Accepted	Angle	Aluminum Clear (A)	Aluminum Matte Black (MB)	Aluminum Champagne (BR)	Stainless Steel Brushed (SS)
1/2"	1-3/8"	5/16"	60°	100.008A	100.008MB	100.008BR	100.008

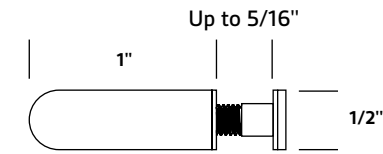

Simply unscrew your desktop stand-off, insert your material, screw the cap back on, and enjoy!



Aluminum Clear (A)

Aluminum Shiny (AS)

Aluminum Black (B)

### 30° Angle and Flat Desktop Standoffs

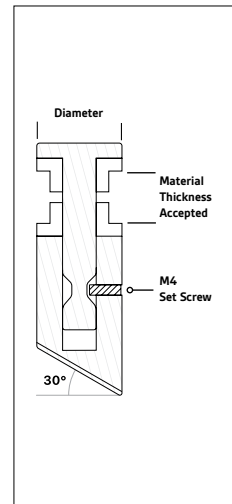

Diameter	Head	Material Thickness Accepted	Angle	Stainless Steel Brushed (SS)
1/2"	Rounded	5/16"	30°	100.102
1/2"	Flat	5/16"	30°	100.002
1/2"	Flat 0.08"	1/8" to 5/16"	0°	100.007



Full Set with Glass  
SKU: FSD3



Aluminum Matte Black (MB)

Aluminum Gold (G)

Aluminum Champagne (BR)

Stainless Steel Satin Brushed (SS)

Diameter	Length	Material Thickness Accepted	Aluminum Clear (A)	Aluminum Shiny (AS)	Aluminum Black (B)	Aluminum Matte Black (MB)	Aluminum Gold (G)	Aluminum Champagne (BR)	Stainless Steel Brushed (SS)
1/2"	1"	1/8" to 5/16"	102.005A	102.005AS	102.005B	102.005MB	102.005G	102.005BR	102.005



## Cylinder & Conical Desktop Standoffs

- Product**  
Cap  
Set Screw  
Barrel
- Unique Features**  
Indoor  
Counter Spaces  
Tabletops
- Area Of Use**  
Trade Shows  
Retail Shops  
Offices  
Hospital
- Additional Details**  
Can be adjusted with different set screw.  
\*Contact us for alternate studs for thickness of material.

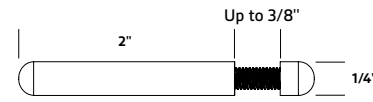

Simply unscrew your desktop standoff, insert your material, screw the cap back on, and enjoy!



Diameter	Length	Material Thickness Accepted	Aluminum Clear (A)	Aluminum Shiny (AS)	Aluminum Black (B)	Aluminum Gold (G)	Aluminum Champagne (BR)	Stainless Steel Brushed (SS)
1/4"	2"	Up to 3/8"	102.001A	N/A	102.001B	102.001G	102.001BR	102.001
1/4"	2-3/4"	Up to 3/8"	102.002A	102.002AS	102.002B	102.002G	102.002BR	102.002

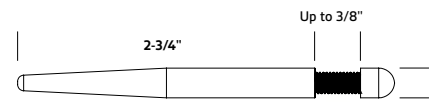

Simply unscrew your desktop standoff, insert your material, screw the cap back on, and enjoy!



Diameter	Length	Material Thickness Accepted	Aluminum Clear (A)	Aluminum Shiny (AS)	Aluminum Black (B)	Aluminum Gold (G)	Aluminum Champagne (BR)	Stainless Steel Brushed (SS)
1/4"	2-3/4"	Up to 3/8"	102.004A	102.004AS	102.004B	102.004G	102.004BR	102.004

\*Contact us for alternate studs for thickness of material

## Cylinder & Conical Desktop Standoffs Kits

### Cylinder Desktop Standoffs Acrylic Kits

- Kit Includes:  
2 x Connectors  
2 x Desktop Standoffs  
2 x Clear Acrylic Frame



Clear Acrylic Holds up to 8 1/2" x 11" paper, photo, or graphic



Frame Size	Insert Size	Aluminum Clear (A)	Aluminum Shiny (AS)	Aluminum Black (B)	Aluminum Gold (G)	Aluminum Champagne (BR)	Stainless Steel Brushed (SS)
12-1/2" x 10"	8.5" x 11"	AC12510-3A	AC12510-3AS	AC12510-3B	AC12510-3G	AC12510-3BR	AC12510-3SS

### Conical Desktop Standoffs Acrylic Kits

- Kit Includes:  
2 x Connectors  
2 x Desktop Standoffs  
2 x Clear Acrylic Frame



Frame Size	Insert Size	Aluminum Clear (A)	Aluminum Shiny (AS)	Aluminum Black (B)	Aluminum Gold (G)	Aluminum Champagne (BR)	Stainless Steel Brushed (SS)
12-1/2" x 10"	8.5" x 11"	AC12510-3TA	AC12510-3TAS	AC12510-3TB	AC12510-3TG	AC12510-3TBR	AC12510-3TSS

## Conical Edge Grip Desktop Standoffs

- Product**: Cap, Barrel
- Unique Features**: Indoor, Counter Spaces, Tabletops, 8 Different Finishes
- Area Of Use**: Trade Shows, Retail Shops, Offices, Hospital
- Additional Details**: Beautiful look for any office, business, or professional setting.

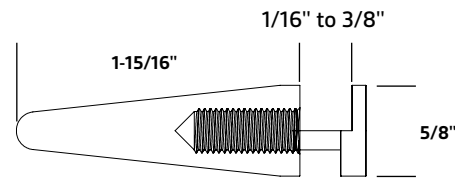

Simply unscrew your desktop standoff, insert your material, screw the cap back on, and enjoy!



Diameter	Length	Material Thickness Accepted	Aluminum Clear (A)	Aluminum Matte Black (MB)	Aluminum Gold (G)	Aluminum Champagne (BR)	Aluminum Bronze (AB)	Aluminum Titanium (T)	Stainless Steel Brushed (S)	Stainless Steel Polished (SP)
5/8"	1-15/16"	1/16" to 3/8"	104.000A	104.000MB	104.000G	104.000BR	104.000AB	104.000T	104.000S	104.000SP

## Material Connectors



Diameter	Head Height	Material Thickness Accepted	Aluminum Clear (A)	Aluminum Black (B)	Stainless Steel Brushed (S)
3/8"	Flat 1/4"	5/16" to 1/2"	MC038A	MC038B	MC038S
3/8"	Flat 1/16"	1/4" to 3/8"	MCS038A	MCS038B	MCS038S
1/2"	Flat 1/16"	3/16" to 3/8"	N/A	N/A	100.020

### 5/16" Diameter Material Connectors

Description	Length	Material Thickness Accepted	Aluminum Clear (A)	Aluminum Shiny (AS)	Aluminum Black (B)	Aluminum Champagne (BR)	Aluminum Gold (G)	Stainless Steel Brushed (SS)
Material Connector	1/4"	1/4" to 3/8"	102.003A*	102.003AS*	102.003B*	102.003BR*	102.003G*	102.003*

\* Can be adjusted with different set screw

Also Available in Matte Black

### 5/8" Desktop Bottom Table Standoffs

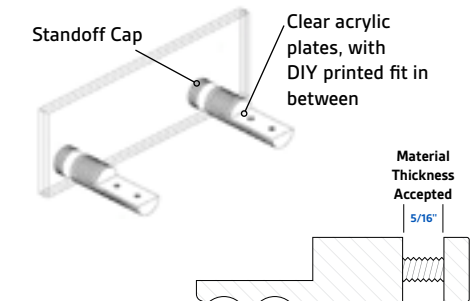

Diameter	Head Height	Material Thickness Accepted	Aluminum Clear (A)	Aluminum Black (B)	Stainless Steel (201) Satin Brushed (SS)
5/8"	Flat 1/4"	5/16"	100.010A	100.010B	100.010SS



## Aluminum Talk Thru Standoffs

- Product** | Heads  
Barrel
- Unique Features** | Indoor & Outdoor  
3 Different Finishes  
5 Different Sizes
- Area Of Use** | Banks  
Ticket Counters  
Stadiums  
DMV's
- Additional Details** | The sound passes through the spacing in the offset of the two panes.



## Stainless Steel Talk Thru Edge Grip Standoffs

- Product** | Standoff
- Unique Features** | Indoor & Outdoor  
2 Different Finishes
- Area Of Use** | Banks  
Ticket Counters  
Stadiums  
DMV's
- Additional Details** | The sound passes through the spacing in the offset of the two panes



### Standoff Selection Guide

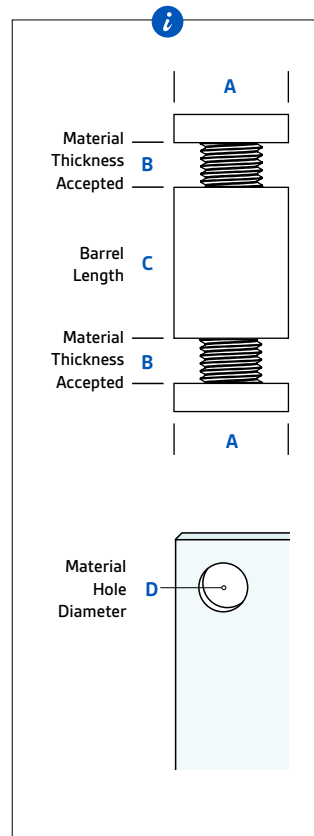

Standoff Head Diameter A	Material Thickness Accepted B	Standoff Height C	Material Hole Diameter D	Clear (A)	Matte Black (MB)	Champagne (BR)
3/8"				ASDS038-100A	ASDS038-100MB	ASDS038-100BR
1/2"				ASDS050-100A	ASDS050-100MB	ASDS050-100BR
7/8"	5/16"	1"	7/8"	ASDS058-100A	ASDS058-100MB	ASDS058-100BR
3/4"				ASDS075-100A	ASDS075-100MB	ASDS075-100BR
1"				ASDS100-100A	ASDS100-100MB	ASDS100-100BR



Our "Talk Thru" Edge Grip Standoffs allow you to attach a glass or Acrylic disc, without drilling. The sound passes through the spacing in the offset of the two panes. This device is fixed on a glass or acrylic window. The "Talk Thru" Edge Grip Standoff are made from Stainless Steel 304 grade. They guarantee you a long hold over time.



Diameter	Thickness Material Accepted	Length	Stainless Steel Satin Brushed (SS)
3/4"	1/4" to 5/16"	7/8"	ST075SS

Diameter	Thickness Material Accepted	Length	Stainless Steel Polished (SP)
3/4"	1/4" to 5/16"	7/8"	ST075SP

## Stainless Steel Panel Mount Standoffs

- Product**
  - Cover Cap
  - Body
  - Threaded Ring
- Unique Features**
  - Indoor & Outdoor
  - 2 Different Finishes
  - Decorative Panels
  - Heavy Duty Signage
  - Substrates
  - Glass & Acrylics
- Area Of Use**
  - Decorative Panels
  - Heavy Duty Signage
  - Substrates
  - Glass
- Additional Details**
  - Made from 316 Marine Grade Stainless Steel.

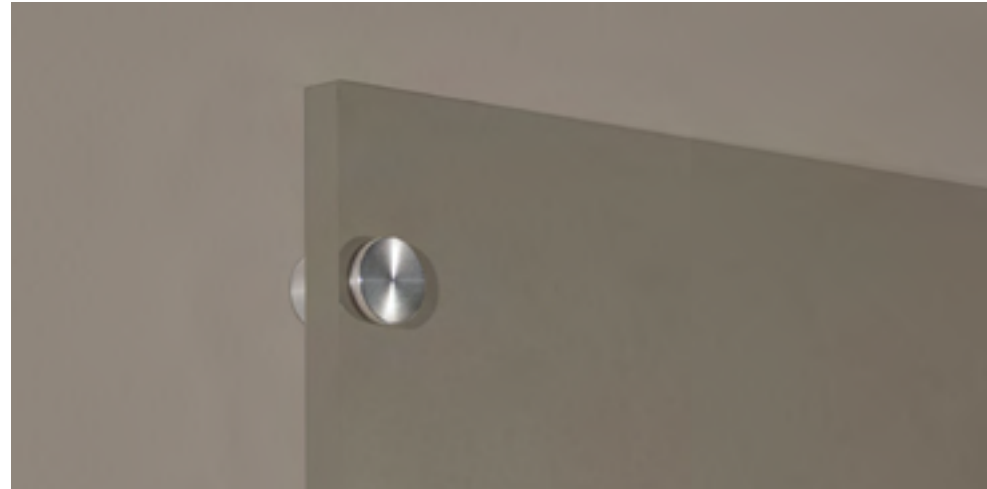
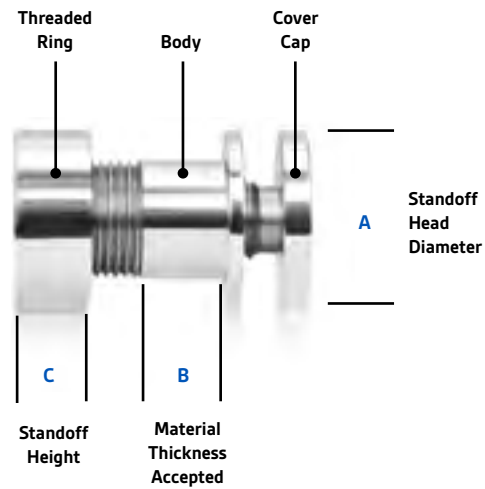

Panel Mount Standoffs are a quick and easy method to mount 5/16" to 3/8" (8 to 10 mm) glass, signage or decorative panels to any substrate without requiring assistance.

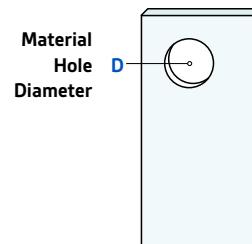

Standoff Head Diameter A	Material Thickness Accepted B	Standoff Height C	Material Hole Diameter D	Stainless Steel Satin Brushed (SS)	Stainless Steel Polished (SP)
3/4"	5/16" to 3/8"	5/16" 6"	9/16"	SOPMBS-316SS	SOPMBS-316SP

## Signage Glass



### Full Kits

Glass Type	Glass Size	Diameter	Barrel Height	# of Holes	SKU
Flat	6" x 3-1/8"	1/2"	2/3"	2	FS1
Flat	6" x 3-1/8"	1/2"	1"	2	FS3
Curved	5-15/16" x 5-15/16"	1/2"	1"	4	FS17

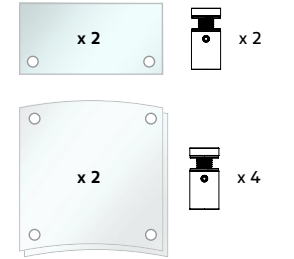

### Glasses Only

0.16" Thickness	Flat - Sold by Unit - With holes - Without holes - Portrait - Landscape	0.16" Thickness	Flat - Sold set of 2 - With holes - Portrait - Landscape	0.16" Thickness	Curved - Sold set of 2 - With holes	3/16" Thickness	Tempered Glass Shelves - No holes
-----------------	--	-----------------	--	-----------------	---	-----------------	--------------------------------------

Glass Type	Glass Size	Thickness	# of Holes	SKU
Flat (1)	6" x 6"	0.16"	4	200.303
	8" x 8"		4	200.305
	5" x 5"		4	200.332
	6-1/8" x 3-1/8"		2	250.011
	6" x 4"		2	250.013.A
	6" x 3-1/8"		2	250.029.A
	8-1/2" x 11"		N/A	250.330
	17" x 11"		N/A	250.360
	17" x 11"		4	250.361
	19-3/8" x 13-3/8"		N/A	250.370
	19-3/8" x 13-3/8"		4	250.371
	10" x 2"		2	260.110
	12" x 2"		2	260.120
	8" x 3"		2	260.130
10" x 3"	2	260.140		
12" x 3"	2	260.150		
12" x 4"	2	260.160		
Flat (2) Portrait	11" x 17"	0.16"	2	250.284
Flat (2) Landscape	17" x 11"	0.16"	4	250.285
Curved (2)	6" x 6"		4	210.303.Q



## Aluminum Non-Adjustable Sign Clamps

- Product** | Sign Clamp
- Unique Features** | Indoor Use Only  
2 Different Finishes  
5 Different Lengths
- Area Of Use** | Retail Shops  
Offices  
Hospitals  
Museums  
Malls
- Additional Details** | Channel  
Non-Adjustable  
Requires (2mm)  
Allen Key

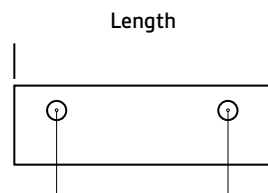
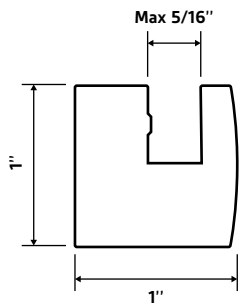

- 2-1/8" (54mm)
- 3-11/16" (94mm)
- 6-1/16" (154mm)
- 10" (254mm)
- 13-15/16" (354mm)



Length	Material Thickness Accepted	Aluminum Clear Satin (ST)	Aluminum Chrome Polished (CP)
3-1/8"		R100-80-ST	R100-80-CP
4-3/4"		R100-120-ST	R100-120-CP
7-1/16"	1/8" to 5/16"	R100-180-ST	R100-180-CP
11"		R100-280-ST	R100-280-CP
14-5/16"		R100-380-ST	R100-380-CP

Use for drywall: Combination of 2 x screw 2216 and 2 x anchor ANC6 or 2 x ANC6Z  
Use for concrete: Combination of 2 x screw 2216 and 2 x anchor ANC2

## Aluminum Adjustable Sign Clamps

- Product** | Sign Clamp
- Unique Features** | Indoor Use Only  
Optional Adjustments  
2 Different Finishes  
5 Different Lengths
- Area Of Use** | Retail Shops  
Offices  
Hospitals  
Museums  
Malls
- Additional Details** | 2 Part Channel  
Adjustable  
Requires (2mm)  
Allen Key

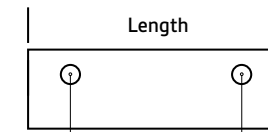
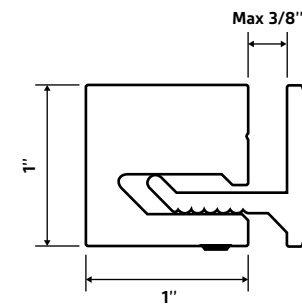

- 2-1/16" (52.50mm)
- 3-21/32" (92.50mm)
- 6" (152.50mm)
- 9-15/16" (252.50mm)
- 13-7/8" (352.50mm)

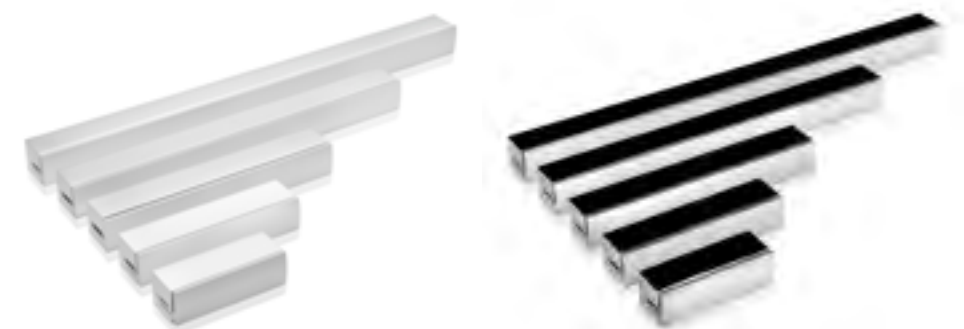

Length	Material Thickness Accepted	Aluminum Clear Satin (ST)	Aluminum Chrome Polished (CP)
3-1/8"		R100A-80-ST	R100A-80-CP
4-3/4"		R100A-120-ST	R100A-120-CP
7-1/16"	1/16" to 3/8"	R100A-180-ST	R100A-180-CP
11"		R100A-280-ST	R100A-280-CP
14-5/16"		R100A-380-ST	R100A-380-CP

Use for drywall: Combination of 2 x screw 2216 and 2 x anchor ANC6 or 2 x ANC6Z  
Use for concrete: Combination of 2 x screw 2216 and 2 x anchor ANC2

## Aluminum LED Sign Clamps

- Product** | Sign Clamp
- Unique Features** | Indoor Use Only  
5 Different Lengths  
3 Color variations + RGB  
120V Transformer Included
- Area Of Use** | Malls  
Retail Shops  
Offices  
Hospitals
- Additional Details** | For better illumination edges of acrylic must be polished. Wires and transformer will need to be hidden inside wall. Requires professional installation



### RGB Color Sign Clamps

- Included:**
- 1 x Sign Clamp
  - 1 x Allen Key
  - 2 x Screw and Anchor
  - 1 x Bluetooth Splitter Hub
  - 1 x Remote Control
  - 1 x 120v Adapter

No subscriptions, hidden fees or credit card required!



### Solid Color Sign Clamps

- Included:**
- 1 x Sign Clamp
  - 1 x Allen Key
  - 2 x Screw and Anchor
  - 1 x Splitter Hub
  - 1 x 120v Adapter

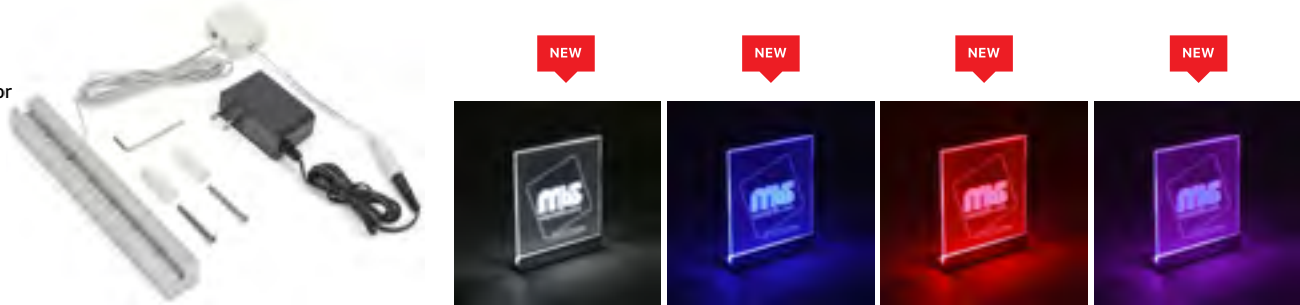

Size	Standoff	Material Thickness Accepted	Standoff Length	Cable Length	White LED	Blue LED	Red LED	RGB LED
1"	1"	1/4" to 5/16"	3-1/8"	77"	LWR100A-80A	LBR100A-80A	LRR100A-80A	LRR100A-80RGB
			4-3/4"		LWR100A-120A	LBR100A-120A	LRR100A-120A	LRR100A-120RGB
			7-1/16"		LWR100A-180A	LBR100A-180A	LRR100A-180A	LRR100A-180RGB
			11"		LWR100A-280A	LBR100A-280A	LRR100A-280A	LRR100A-280RGB
			14-15/16"		LWR100A-380A	LBR100A-380A	LRR100A-380A	LRR100A-380RGB

Use for drywall: screw 2216 and anchor ANC6, ANC6Z. Use for concrete: screw 2216 and anchor ANC2

## Aluminum Rectangular Edge Grip Standoffs

- Product** | Rectangular cap  
Round Barrel
- Unique Features** | Indoor  
6 Different Finishes  
Signage  
Wayfinder  
Display  
Advertising
- Area Of Use** | Retail Shops  
Offices  
Hospitals
- Additional Details** | No holes in material required.  
Requires (2mm) Allen Key



Requires (2mm) Allen Key.

SKU: ALLENM2

Rectangle	Thickness Of Material Accepted	Clear (A)	Clear Kit (A)	Shiny (AS)	Shiny Kit (AS)	Black (B)	Black Kit (B)
3/4" x 1/2"	1/8" to 5/16"	REG050-038A	REG050-038A-KIT	REG050-038AS	REG050-038AS-KIT	REG050-038B	REG050-038B-KIT

Rectangle	Thickness Of Material Accepted	Gold (G)	Gold Kit (G)	Bronze (AB)	Bronze Kit (AB)	Titanium (T)	Titanium Kit (T)
3/4" x 1/2"	1/8" to 5/16"	REG050-038G	REG050-038G-KIT	REG050-038AB	REG050-038AB-KIT	REG050-038T	REG050-038T-KIT

Use for drywall: Screw 2208 anchor ANC5, ANC5Z. Use for concrete: Screw 2208 and anchor ANC1

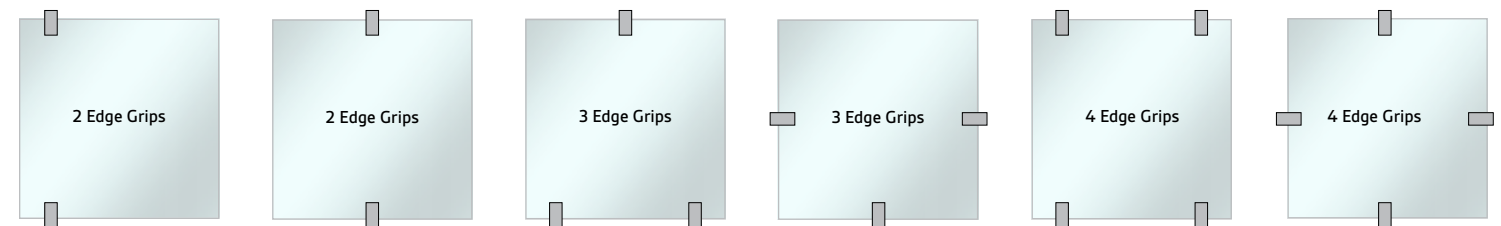



## Adjustable Edge Grip Standoffs

- Product** | Edge Grip
- Unique Features** | Indoor  
6 Different Finishes  
7 Different Diameters  
Signage  
Wayfinder  
Display  
Advertising
- Area Of Use** | Retail Shops  
Offices  
Hospitals
- Additional Details** | No holes in material required.

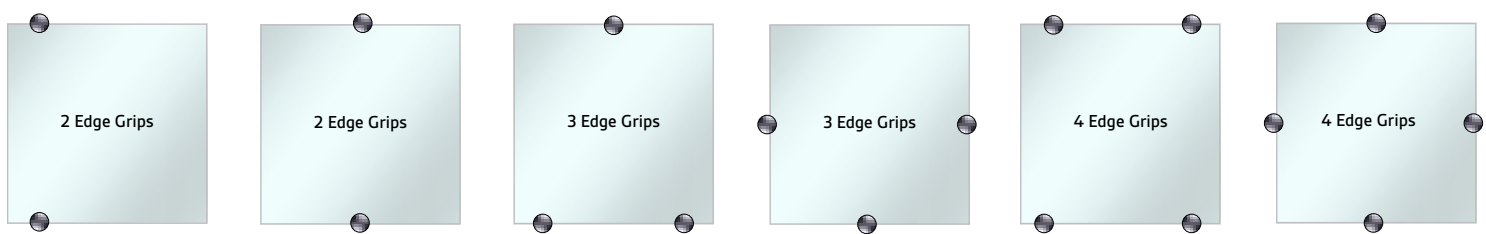

## Adjustable Edge Grip Standoffs

Diameter	Length	Material Thickness Accepted	Aluminum Clear (A)	Aluminum Shiny (AS)	Aluminum Black (B)	Aluminum Gold (G)	Stainless Steel Brushed (S)	Stainless Steel Polished (P)
1/2"	1/2"	0 to 1/4"	EG050-050A	EG050-050AS	EG050-050B	EG050-050G	EG050-050S	EG050-050P
	3/4"	0 to 3/8"	EG050-075A	EG050-075AS	EG050-075B	EG050-075G	EG050-075S	EG050-075P
	1"	0 to 3/8"	EG050-100A	EG050-100AS	EG050-100B	EG050-100G	EG050-100S	EG050-100P
	1-1/2"	0 to 3/8"	EG050-150A	EG050-150AS	EG050-150B	EG050-150G	EG050-150S	EG050-150P
	2"	0 to 3/8"	EG050-200A	EG050-200AS	EG050-200B	EG050-200G	EG050-200S	EG050-200P
5/8"	1/2"	0 to 1/4"	EG058-050A	EG058-050AS	EG058-050B	EG058-050G	EG058-050S	EG058-050P
	3/4"	0 to 3/8"	EG058-075A	EG058-075AS	EG058-075B	EG058-075G	EG058-075S	EG058-075P
	1"	0 to 3/8"	EG058-100A	EG058-100AS	EG058-100B	EG058-100G	EG058-100S	EG058-100P
	1-1/2"	0 to 3/8"	EG058-150A	EG058-150AS	EG058-150B	EG058-150G	EG058-150S	EG058-150P
	2"	0 to 3/8"	EG058-200A	EG058-200AS	EG058-200B	EG058-200G	EG058-200S	EG058-200P
3/4"	1/2"	0 to 1/4"	EG075-050A	EG075-050AS	EG075-050B	EG075-050G	EG075-050S	EG075-050P
	3/4"	0 to 3/8"	EG075-075A	EG075-075AS	EG075-075B	EG075-075G	EG075-075S	EG075-075P
	1"	0 to 1/2"	EG075-100A	EG075-100AS	EG075-100B	EG075-100G	EG075-100S	EG075-100P
	1-1/2"	0 to 1/2"	EG075-150A	EG075-150AS	EG075-150B	EG075-150G	EG075-150S	EG075-150P
	2"	0 to 1/2"	EG075-200A	EG075-200AS	EG075-200B	EG075-200G	EG075-200S	EG075-200P
7/8"	1/2"	0 to 1/4"	EG087-050A	EG087-050AS	EG087-050B	EG087-050G	EG087-050S	EG087-050P
	3/4"	0 to 3/8"	EG087-075A	EG087-075AS	EG087-075B	EG087-075G	EG087-075S	EG087-075P
	1"	0 to 1/2"	EG087-100A	EG087-100AS	EG087-100B	EG087-100G	EG087-100S	EG087-100P
	1-1/2"	0 to 1/2"	EG087-150A	EG087-150AS	EG087-150B	EG087-150G	EG087-150S	EG087-150P
	2"	0 to 1/2"	EG087-200A	EG087-200AS	EG087-200B	EG087-200G	EG087-200S	EG087-200P
1"	1/2"	0 to 1/4"	EG100-050A	EG100-050AS	EG100-050B	EG100-050G	EG100-050S	EG100-050P
	3/4"	0 to 3/8"	EG100-075A	EG100-075AS	EG100-075B	EG100-075G	EG100-075S	EG100-075P
	1"	0 to 1/2"	EG100-100A	EG100-100AS	EG100-100B	EG100-100G	EG100-100S	EG100-100P
	1-1/2"	0 to 1/2"	EG100-150A	EG100-150AS	EG100-150B	EG100-150G	EG100-150S	EG100-150P
	2"	0 to 1/2"	EG100-200A	EG100-200AS	EG100-200B	EG100-200G	EG100-200S	EG100-200P
1-1/4"	1/2"	0 to 1/4"	EG125-050A	EG125-050AS	EG125-050B	EG125-050G	EG125-050S	EG125-050P
	3/4"	0 to 3/8"	EG125-075A	EG125-075AS	EG125-075B	EG125-075G	EG125-075S	EG125-075P
	1"	0 to 1/2"	EG125-100A	EG125-100AS	EG125-100B	EG125-100G	EG125-100S	EG125-100P
	1-1/2"	0 to 1/2"	EG125-150A	EG125-150AS	EG125-150B	EG125-150G	EG125-150S	EG125-150P
	2"	0 to 1/2"	EG125-200A	EG125-200AS	EG125-200B	EG125-200G	EG125-200S	EG125-200P
1-1/2"	1/2"	0 to 1/4"	EG150-050A	EG150-050AS	EG150-050B	EG150-050G	EG150-050S	EG150-050P
	3/4"	0 to 3/8"	EG150-075A	EG150-075AS	EG150-075B	EG150-075G	EG150-075S	EG150-075P
	1"	0 to 1/2"	EG150-100A	EG150-100AS	EG150-100B	EG150-100G	EG150-100S	EG150-100P
	1-1/2"	0 to 1/2"	EG150-150A	EG150-150AS	EG150-150B	EG150-150G	EG150-150S	EG150-150P
	2"	0 to 1/2"	EG150-200A	EG150-200AS	EG150-200B	EG150-200G	EG150-200S	EG150-200P

For 1/2" and 5/8" Diameter: Use for drywall: screw 2208 anchor ANC5, ANC5Z. Use for concrete: anchor 2208 and anchor: ANC1  
For 3/4" to 1-1/2" Diameter: Use for drywall: screw 2216 anchor ANC6, ANC6Z. Use for concrete: screw 2216 and anchor ANC2

## Non-Adjustable Edge Grip Standoffs

- Product** | Edge Grip Standoff
- Unique Features** | Indoor Use Only  
Non adjustable
- Area Of Use** | Signage  
Wayfinder  
Display  
Advertising
- Additional Details** | Design for flat material signs



Single Channel



Single Channel



Double Channel

**!** Requires (2mm) Allen Key.  
SKU: ALLENM2

### Configuration Examples

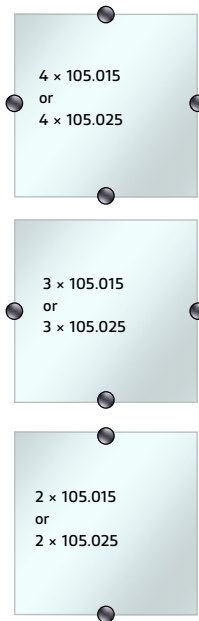
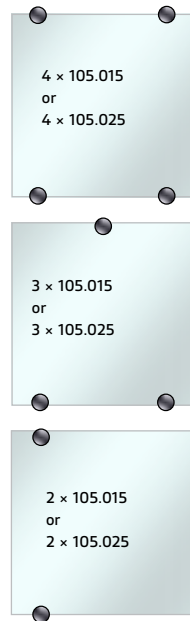
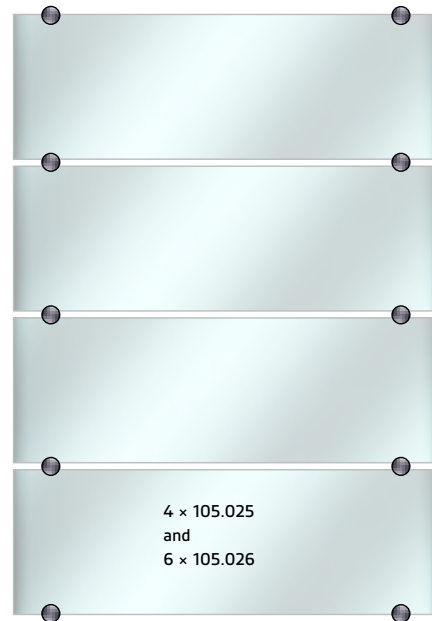
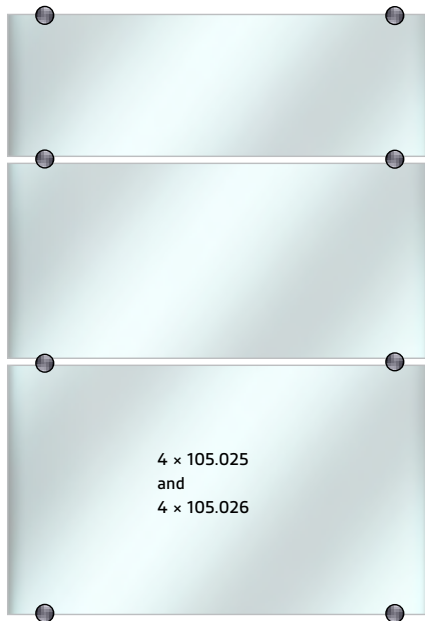

## Non-Adjustable Edge Grip Standoffs

### 7 Finishes



Diameter	Length	Material Thickness Accepted	Type	Aluminum Clear (A)	Aluminum Shiny (AS)	Aluminum Black (B)	Aluminum Gold (G)	Aluminum Bronze (AB)	Aluminum Titanium (T)	Stainless Steel Brushed (SS)
9/16"	9/16"	5/16"	Single Channel	105.015A	105.015AS	105.015B	105.015G	105.015AB	105.015T	105.015
1"	9/16"	5/16"	Single Channel	105.025A	105.025AS	105.025B	105.025G	105.025AB	105.025T	105.025
	9/16"	5/16"	Double Channel	105.026A	105.026AS	105.026B	105.026G	105.026AB	105.026T	105.026

For 9/16" Diameter: Use for drywall: screw 2208 anchor ANC5, ANC5Z. Use for concrete: anchor 2208 and anchor ANC1  
For 1" Diameter: Use for drywall: screw 2216 anchor ANC6, ANC6Z. Use for concrete: screw 2216 and anchor ANC2

### Single Channel



SKU: 105.015

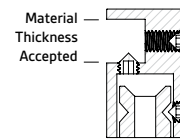

### Single Channel



SKU: 105.025

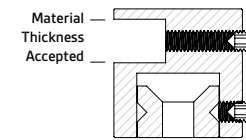

### Double Channel



SKU: 105.026

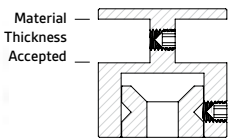

### Edge Grip Kits

- Non adjustable
- Easy access to set screw to lock into place
- Hardware included
- Sold without acrylic



Diameter	Length	Material Thickness Accepted	Aluminum Clear (A)	Aluminum Black (B)	Insert Size	Frame Size	Aluminum Clear (A)	Aluminum Black (B)
3/4"	7/8"	5/16"	ASA1922A	ASA1922B	8-1/2" x 11"	9.69" x 11.12"	ASA1922A-K	ASA1922B-K

Use for drywall: screw 2208 anchor ANC5, ANC5Z.  
Use for concrete: anchor 2208 and anchor ANC1

Use for drywall: screw 2208 anchor ANC5, ANC5Z.  
Use for concrete: anchor 2208 and anchor ANC1

### Edge Grip Kits with 8-1/2" x 11" Acrylic

- Non adjustable
- Easy access to set screw to lock into place
- Hardware included
- Sold with acrylic





## Stainless Steel Glass Standoffs

- Product** Glass Standoffs & Caps
- Unique Features** Indoor & Outdoor  
3 Different Finishes
- Area Of Use** Homes  
Offices  
Malls  
Hotels  
Yacht
- Additional Details** Beautiful look for any home, business, or professional setting



Stainless Steel Brushed Glass Standoffs  
SKU: R50B20SS



Stainless Steel Polished Glass Standoffs  
SKU: R50B20SP

### Caps Only

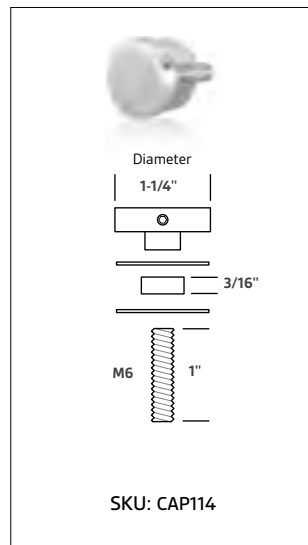
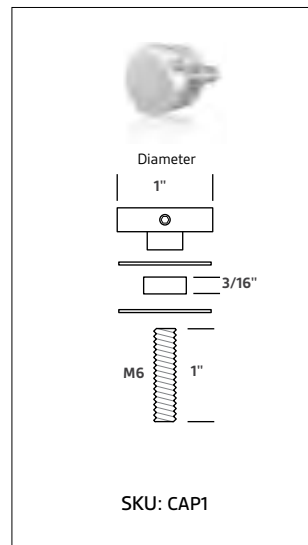

### Caps and Barrel Set

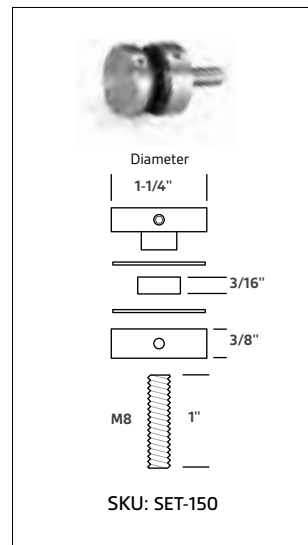

SKU: SF-50M8



SKU: SO-NB48X30  
Available upon request.

## Stainless Steel Glass Standoffs

### For Heavy Duty Glass

Diameter	Material Thickness Accepted	Length	Grade	Matte Black (MB)	Satin Brushed (SS)	Polished (SP)
1-1/2"	3/8" to 13/16"	5/8"	304	AGSB150-058-304MB	AGSB150-058-304SS	AGSB150-058-304SP
			316	AGSB150-058-316MB	AGSB150-058-316SS	AGSB150-058-316SP



### For Strong Glass

Diameter	Material Thickness Accepted	Length	Grade	Matte Black (MB)	Satin Brushed (SS)	Polished (SP)
1-1/2"	3/8" to 13/16"	1"	304	AGSB150-100-304MB	AGSB150-100-304SS	AGSB150-100-304SP
			316	AGSB150-100-316MB	AGSB150-100-316SS	AGSB150-100-316SP
			316L	AGSB150-100-316LMB	AGSB150-100-316LSS	AGSB150-100-316LSP



### For Strong Glass

Diameter	Material Thickness Accepted	Length	Grade	Matte Black (MB)	Satin Brushed (SS)	Polished (SP)
2"	3/8" to 13/16"	2"	304	AGSB200-150-304MB	AGSB200-150-304SS	AGSB200-150-304SP
			316	AGSB200-150-316MB	AGSB200-150-316SS	AGSB200-150-316SP
			316L	AGSB200-150-316LMB	AGSB200-150-316LSS	AGSB200-150-316LSP



### Tools



Adjustable Spanner Wrench  
SKU: SW30



Replaceable 2.30mm Pin (Set of 2)  
SKU: SW30-23



Replaceable 2.90mm Pin (Set of 2)  
SKU: SW30-29

## Stainless Steel Glass Spigot Standoffs

<b>Product</b>	Spigot
<b>Unique Features</b>	Indoor & Outdoor 3 Different Finishes 2 Different Styles
<b>Area Of Use</b>	Pools Balconies Stair Rails Decks
<b>Additional Details</b>	Designed for 3/8" tempered or 1/2" thick laminated glass. Does not require any holes to be drilled in the glass. Two spigot clamps can support up to a 4' panel of glass

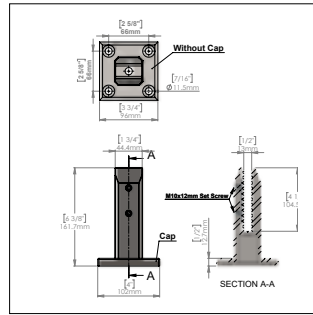
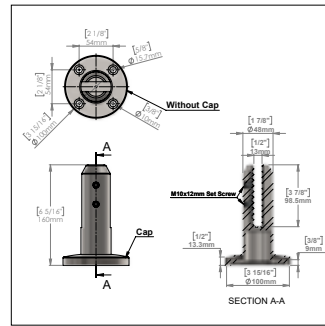

Description	Mounting	Brushed (Square base) (SS)	Polished (Square base) (SP)	Matte Black (Round base) (MB)
304** stainless steel square glass spigots are designed for use when the material will be exposed to humid areas and has excellent corrosion resistance.	(4) 316 or 304 Stainless Steel sleeve and a 5/16" diameter anchor	SPIGOT1316SS	SPIGOT1316SP	SPIGOT2316MB
High Grade 316* stainless steel, square glass spigots are designed for use when the material will be exposed to corrosive elements or exposed to water consistently. Perfect for applications where greater strength is required.		SPIGOT1304SS	SPIGOT1304SP	SPIGOT2304MB

## Mall Front Clamps

<b>Product</b>	Clamps Silicon Washers Screws
<b>Unique Features</b>	Indoor & Outdoor 11 Different Finishes
<b>Area Of Use</b>	Malls Airports Businesses
<b>Additional Details</b>	Perfect for joining vertical interior panels of heavy glass in malls, these Mall Front Clamps offer convenience and safety.

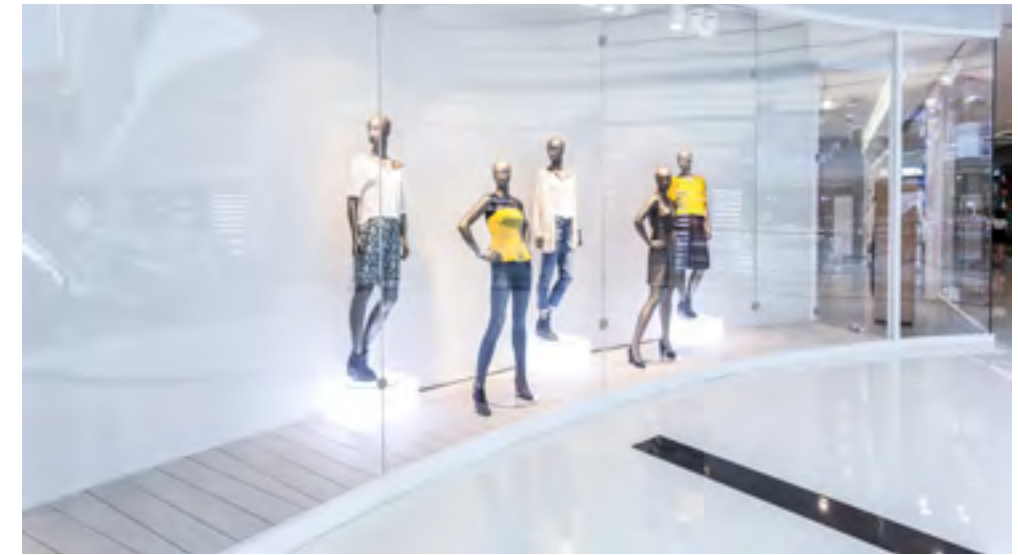

\* More details on back side

### Cylinder Clamps

- What's included Per Unit:**
- 1 x Mall Front Clamps
  - 2 x Clear Silicone Washer
  - 1 x Hex Drive Flat Head Screws M4 x 18mm
  - 1 x Hex Drive Flat Head Screws M4 x 20mm
  - 1 x Hex Drive Flat Head Screws M4 x 30mm
  - 1 x 1/8" Allen Wrench



### Tamper Proof Cylinder Clamps

- What's included Per Unit:**
- 1 x Mall Front Clamps
  - 2 x Clear Silicone Washer
  - 1 x Set Screw M5 x 10mm
  - 1 x Set Screw M5 x 16mm
  - 1 x 1.8 x 50mm pin
  - (Very strong material to tighten cap)



### Tamper Proof Beveled Clamps

- What's included Per Unit:**
- 1 x Mall Front Clamps
  - 2 x Clear Silicone Washer
  - 1 x Set Screw M5 x 10mm
  - 1 x Set Screw M5 x 12mm
  - 1 x 1.8 x 50mm pin
  - (Very strong material to tighten cap)



### Square Clamps

- What's included Per Unit:**
- 1 x Mall Front Clamps
  - 2 x Clear Silicone Washer
  - 2 x Hex Drive Flat Head Screws M4 x 18mm
  - 2 x Hex Drive Flat Head Screws M4 x 20mm
  - 2 x Hex Drive Flat Head Screws M4 x 30mm
  - 1 x 2.5mm Allen Wrench





## Aluminum Mall Front Clamps

### Cylinder Clamps

Diameter	Thickness Material Accepted	NEW				
		Aluminum Clear (A)	Aluminum Shiny (AS)	Aluminum Matte Black (MB)	Aluminum Gold (G)	Aluminum Champagne (BR)
3/4"	1/4" to 1/2"	MFC075A	MFC075AS	MFC075MB	MFC075G	MFC075BR
7/8"		MFC087A	MFC087AS	MFC087MB	MFC087G	MFC087BR
1"		MFC100A	MFC100AS	MFC100MB	MFC100G	MFC100BR
1-1/4"		MFC125A	MFC125AS	MFC125MB	MFC125G	MFC125BR
1-1/2"		MFC150A	MFC150AS	MFC150MB	MFC150G	MFC150BR
2"		MFC200A	MFC200AS	MFC200MB	MFC200G	MFC200BR

### Tamper Proof Cylinder Clamps

Diameter	Thickness Material Accepted	NEW				
		Aluminum Clear (A)	Aluminum Shiny (AS)	Aluminum Matte Black (MB)	Aluminum Gold (G)	Aluminum Champagne (BR)
2"	1/4" to 1/2"	M200A	M200AS	M200MB	M200G	M200BR

### Tamper Proof Beveled Clamps

Diameter	Thickness Material Accepted	NEW				
		Aluminum Clear (A)	Aluminum Shiny (AS)	Aluminum Matte Black (MB)	Aluminum Gold (G)	Aluminum Champagne (BR)
1-1/2"	1/4" to 1/2"	MC150A	MC150AS	MC150MB	MC150G	MC150BR

### Square Clamps

Diameter	Thickness Material Accepted	NEW				
		Aluminum Clear (A)	Aluminum Shiny (AS)	Aluminum Matte Black (MB)	Aluminum Gold (G)	Aluminum Champagne (BR)
1-1/2"	1/4" to 1/2"	MSC2-150A	MSC2-150AS	MSC2-150MB	MSC2-150G	MSC2-150BR
2"		MSC2-200A	MSC2-200AS	MSC2-200MB	MSC2-200G	MSC2-200BR

## Stainless Steel Mall Front Clamps

Diameter	Thickness Material Accepted	NEW					
		Stainless Steel Matte Black 304 (MB)	Stainless Steel Satin Brushed 304 (SS)	Stainless Steel Polished 304 (SP)	Stainless Steel Matte Black 316 (MB)	Stainless Steel Satin Brushed 316 (SS)	Stainless Steel Polished 316 (SP)
3/4"	1/4" to 1/2"	MFC075SS304MB	MFC075SS304S	MFC075SS304P	MFC075SS316MB	MFC075SS316S	MFC075SS316P
7/8"		MFC087SS304MB	MFC087SS304S	MFC087SS304P	MFC087SS316MB	MFC087SS316S	MFC087SS316P
1"		MFC100SS304MB	MFC100SS304S	MFC100SS304P	MFC100SS316MB	MFC100SS316S	MFC100SS316P
1-1/4"		MFC125SS304MB	MFC125SS304S	MFC125SS304P	MFC125SS316MB	MFC125SS316S	MFC125SS316P
1-1/2"		MFC150SS304MB	MFC150SS304S	MFC150SS304P	MFC150SS316MB	MFC150SS316S	MFC150SS316P
2"		MFC200SS304MB	MFC200SS304S	MFC200SS304P	MFC200SS316MB	MFC200SS316S	MFC200SS316P

Diameter	Thickness Material Accepted	NEW					
		Stainless Steel Matte Black 304 (MB)	Stainless Steel Satin Brushed 304 (SS)	Stainless Steel Polished 304 (SP)	Stainless Steel Matte Black 316 (MB)	Stainless Steel Satin Brushed 316 (SS)	Stainless Steel Polished 316 (SP)
2"	1/4" to 1/2"	M200SS304MB	M200SS304S	M200SS304P	M200SS316MB	M200SS316S	M200SS316P

Diameter	Thickness Material Accepted	NEW					
		Stainless Steel Matte Black 304 (MB)	Stainless Steel Satin Brushed 304 (SS)	Stainless Steel Polished 304 (SP)	Stainless Steel Matte Black 316 (MB)	Stainless Steel Satin Brushed 316 (SS)	Stainless Steel Polished 316 (SP)
1-1/2"	1/4" to 1/2"	MC150SS304MB	MC150SS304S	MC150SS304P	MC150SS316MB	MC150SS316S	MC150SS316P





































Diameter	Thickness Material Accepted	NEW					
		Stainless Steel Matte Black 304 (MB)	Stainless Steel Satin Brushed 304 (S)	Stainless Steel Polished 304 (P)	Stainless Steel Satin Brushed 316 (MB)	Stainless Steel Satin Brushed 316 (SS)	Stainless Steel Polished 316 (SP)
1-1/2"	1/4" to 1/2"	MSC2-150SS304MB	MSC2-150SS304S	MSC2-150SS304P	MSC2-150SS316MB	MSC2-150SS316S	MSC2-150SS316P
2"		MSC2-200SS304MB	MSC2-200SS304S	MSC2-200SS304P	MSC2-200SS316MB	MSC2-200SS316S	MSC2-200SS316P

## Hardware for Standoffs

	Description	Diameter	Length	SKU
	Stainless Steel Phillips Flat Head Screw	#6	3/4"	2206
	Stainless Steel Phillips Flat Head Screw	#6	1-1/2"	2208
	Zinc Phillips Flat Head Screw	#6	1-1/2"	2208Z
	Phillips Flat Head Coarse Drywall Screw	#6	1-1/2"	118732
	Phillips Stainless Flat Head	#6	2"	2209
	Concrete/Drywall Plastic Anchor; Drill Size 1/4"	#6	N/A	ANC1
	Low Cost Drywall Nylon Anchor	#6	1-1/4"	SA5P
	Drywall Nylon Anchor	#6	N/A	ANC5
	Drywall Zinc Anchor	#6	N/A	ANC5Z
	Stainless Steel Phillips Flat Head Screw	#8	3/4"	2214
	Stainless Steel Phillips Flat Head Screw	#8	1-1/2"	2216
	Zinc Phillips Flat Head Screw	#8	1-1/2"	2216Z
	Phillips Flat Head Coarse Drywall Screw	#8	1-1/2"	262156
	Stainless Steel Phillips Flat Head Screw	#8	2"	2217
	Concrete/Drywall Plastic Anchor; Drill Size 1/4"	#8	N/A	ANC2
	Low Cost Drywall Nylon Anchor	#8	1-5/8"	LA6P
	Drywall Nylon Anchor	#8	N/A	ANC6
	Drywall Zinc Anchor	#8	1-1/2"	SA6Z
	Drywall Zinc Anchor	#8	1"	LA6Z
	Drywall Zinc Anchor	#8	N/A	ANC6Z
	Phillips Flat Head Screw	#10	1-1/4"	2225
	Concrete/Drywall Plastic Anchor; Drill Size 5/16"	#10	N/A	ANC3
	Phillips Flat Head Screw	#12	1-1/4"	2234
	Concrete/Drywall Plastic Anchor; Drill Size 3/8"	#12	N/A	ANC4
	Drywall Nylon Toggle Wings	#8	Pre-Drill 9/16"	TBW9
	Nylon Toggle Tool Key	N/A	N/A	TBW9K
	Drywall Spring Toggle Wings	#6	N/A	TBW6
	Phillips Flat Head Screw	#6	2-1/2"	2200Z
	Drywall Spring Toggle Wings	#8	N/A	TBW8
	Phillips Flat Head Screw. Phillips Zinc Screw	#8	2-1/2"	2300Z
	Phillips Stainless Steel Truss Head Screws	#6	3/4"	PT6075
		#6	1-1/2"	PT6150
		#8	3/4"	PT8075
		#8	1-1/2"	PT8150

\* Screw and anchor for stronger resistance (select products only)

## Installation Tools for Standoffs

	Description	SKU
	68 Piece Tool Set	SETBIT
	Screw Driver for Hex 1/4" Bit with Ergonomic Rubber Handle	61300
	Mini Stubby Handle for Hex 1/4" Bit	61200
	1/4" Magnetic Bit Holder	MBH1/4
	Phillips Head Insert Bit #1x3"	PH1-3
	Phillips Head Insert Bit #2x2"	PH2-2
	Phillips Head Insert Bit #2x3"	PH2-3
	Hex Tamper Proof: 1.5mmx3-1/8"	611015
	Hex Tamper Proof: 2mmx3-1/8"	611020
	Hex Tamper Proof: 2.5mmx3-1/8"	611025
	Hex Tamper Proof: 3mmx3-1/8"	611030
	Torx Tamper Proof: T10 Bitx3-1/8"	101000
	Torx Tamper Proof: T15 Bitx3-1/8"	101010
	Torx Tamper Proof: T20 Bitx3-1/8"	101020
	Hex Tamper Proof: Stubby Handle 1.5mm	STUBBY15
	Hex Tamper Proof: Stubby Handle 2.0mm	STUBBY2
	Hex Tamper Proof: Stubby Handle 2.5mm	STUBBY25
	Hex Tamper Proof: Stubby Handle 3.0mm	STUBBY3
	Hex Tamper Proof: Stubby Handle	STUBBYSET
	Allen Wrench	ALLENM4
	1.5 Millimeter Allen Wrench, Short Arm	ALLENM15
	2.0 Millimeter Allen Wrench, Short Arm	ALLENM2
	1/8" Allen Wrench, Short Arm	ALLENK1/8
	3/16" Allen Wrench, Short Arm	ALLENK3/16
	3/32" Allen Wrench, Short Arm	ALLENK3/32
	5/32" Allen Wrench, Short Arm	ALLENK5/32
	7/32" Allen Wrench, Short Arm	ALLENK7/32
	1.5 Millimeter Allen Wrench, Ball End, Long Arm	ALLENM15L
	2.5 Millimeter Allen Wrench, Short Arm, Long Arm	ALLENM25
	2.5 Millimeter Allen Wrench, Ball End, Long Arm	ALLENM25L
	2.0 Millimeter Allen Wrench, Ball End, Long Arm	ALLENM2L
	3.0 Millimeter Allen Wrench, Short Arm	ALLENM3
	4.0 Millimeter Allen Wrench, Short Arm	ALLENM4
	4.0 Millimeter Allen Wrench, Ball End, Long Arm	ALLENM4L
	5.0 Millimeter Allen Wrench, Short Arm	ALLENM5
	Standoff Sample Display	DISPLAY-1
	1/4" Cobalt Drill Bit	DB14
	5/32" Cobalt Drill Bit	DB532
	7/32" Cobalt Drill Bit	DB732



(68 Pieces)  
Universal Installation Tool Set  
Dedicated For Signage  
SKU: SETBIT



Screw Driver for Hex 1/4" Bit with Ergonomic rubber handle  
SKU: 61300



Stubby Driver Set for Standoffs and Cable Systems and signage  
SKU: STUBBYSET

Acrylic Sample Display  
SKU: DISPLAY-1

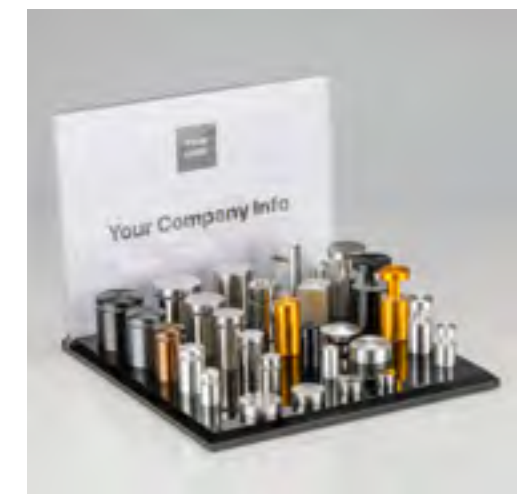





## Standoff Caps & Barrel Systems

	Caps & Barrels	80		Aluminum Hub for Customizable Standoffs	97
	Flat Caps	82		Set Screw Studs	98
	Tamper Proof Caps	82		Plastic Tubing	99
	Rounds Caps	82		Hardware for Customizable Standoffs	100
	Hex-Caps	84		Machine Screws Flat / Pan Head	101
	Multi-Mount Hardware	85		Tools for Customizable Standoffs	102
	Barrels	86			
	Aluminum Square Caps and Barrels	96			

# Caps and Barrels



# CAPS & BARRELS

Affordable! Indoor and Outdoor Signage

**Long Lasting**

Indoor & Outdoor

**Robust**

Solid Material

**Aesthetic**

Elegant Finishes

17 Different Finishes



# Caps and Barrels



Aluminum Clear (A)



Aluminum Shiny (AS\*)



Aluminum Black (B)



Aluminum Bronze (AB)



Aluminum Gold (G)



Aluminum Champagne (BR\*)



Aluminum Blue (BL\*)



Aluminum Copper (CP\*)



Aluminum Green (GN\*)



Aluminum Dark Green (DGN\*)



Aluminum Titanium (T\*)



Aluminum Pink (RP\*)



Aluminum Purple (PL\*)



Aluminum Red (RD\*)



Aluminum Tan (TAN\*)



Stainless Steel Brushed (SS)



Stainless Steel Polished (SP)



Aluminum Clear (A)



Aluminum Shiny (AS\*)



Aluminum Black (B)



Aluminum Bronze (AB)



Aluminum Gold (G)



Aluminum Champagne (BR\*)



Aluminum Blue (BL\*)



Aluminum Copper (CP\*)



Aluminum Green (GN\*)



Aluminum Dark Green (DGN\*)



Aluminum Titanium (T\*)



Aluminum Pink (RP\*)



Aluminum Purple (PL\*)



Aluminum Red (RD\*)



Aluminum Tan (TAN\*)



Stainless Steel Brushed (SS)



Stainless Steel Polished (SP)

(\*) Available upon request minimum order quantity 100



### Flat Caps

Diameter	Cap Height	Type	Thread	Aluminum Clear (A)	Aluminum Shiny (AS)	Aluminum Black (B)	Aluminum Bronze (AB)	Aluminum Gold (G)	Aluminum Champagne (BR)	Aluminum Blue (BL)
1/4"	5/32"	Flat	#6-32	CAP025A	CAP025AS*	CAP025B	CAP025AB*	CAP025G	CAP025BR	CAP025BL*
3/8"	1/4"	Flat	#10-24	CAP038A	CAP038AS	CAP038B	CAP038AB	CAP038G	CAP038BR*	CAP038BL*
1/2"	1/4"	Flat	#10-24	CAP050A	CAP050AS*	CAP050B	CAP050AB*	CAP050G	CAP050BR*	CAP050BL*
5/8"	5/16"	Flat	#10-24	CAP0581024A	CAP0581024AS*	CAP0581024B	CAP0581024AB*	CAP0581024G*	CAP0581024BR*	CAP0581024BL*
	1/4"	Flat	1/4-20	CAP058025A	CAP058025AS*	CAP058025B	CAP058025AB*	CAP058025G	CAP058025BR*	CAP058025BL*
3/4"	5/16"	Flat	5/16-18	CAP058A	CAP058AS*	CAP058B	CAP058AB*	CAP058G	CAP058BR*	CAP058BL*
	3/8"	Flat	#10-24	CAP0751024A	CAP0751024AS*	CAP0751024B	CAP0751024AB*	CAP0751024G*	CAP0751024BR*	CAP0751024BL*
7/8"	1/4"	Flat	1/4-20	CAP075025A	CAP075025AS*	CAP075025B	CAP075025AB*	CAP075025G	CAP075025BR*	CAP075025BL*
	3/8"	Flat	5/16-18	CAP075A	CAP075AS*	CAP075B	CAP075AB*	CAP075G	CAP075BR*	CAP075BL*
1"	1/4"	Flat	#10-24	CAP1001024A	CAP1001024AS*	CAP1001024B	CAP1001024AB*	CAP1001024G*	CAP1001024BR*	CAP1001024BL*
	1/4"	Flat	1/4-20	CAP100025A	CAP100025AS*	CAP100025B	CAP100025AB*	CAP100025G*	CAP100025BR*	CAP100025BL*
	3/8"	Flat	5/16-18	CAP100A	CAP100AS*	CAP100B	CAP100AB	CAP100G	CAP100BR*	CAP100BL*
1-1/4"	1/2"	Flat	5/16-18	CAP125A	CAP125AS*	CAP125B	CAP125AB*	CAP125G	CAP125BR*	CAP125BL*
1-1/2"	1/2"	Flat	5/16-18	CAP150A	CAP150AS*	CAP150B	CAP150AB*	CAP150G	CAP150BR*	CAP150BL*
2"	1/2"	Flat	5/16-18	CAP200A	CAP200AS*	CAP200B	CAP200AB*	CAP200G	CAP200BR*	CAP200BL*

### Tamper Proof Caps

Requires (2mm) Allen Key. SKU: ALLENM2

Diameter	Cap Height	Type	Thread	Aluminum Clear (A)	Aluminum Shiny (AS)	Aluminum Black (B)	Aluminum Bronze (AB)	Aluminum Gold (G)	Aluminum Champagne (BR)	Aluminum Blue (BL)
3/8"	1/4"	Locking	#10-24	CAP038LA	CAP038LAS	CAP038LB	CAP038LAB	CAP038LG	CAP038LBR*	CAP038LBL*
1/2"	1/4"	Locking	#10-24	CAP050LA	CAP050LAS*	CAP050LB	CAP050LAB*	CAP050LG*	CAP050LBR*	CAP050LBL*
5/8"	5/16"	Locking	#10-24	CAP0581024LA	CAP0581024LAS*	CAP0581024LB	CAP0581024LAB*	CAP0581024LG*	CAP0581024LBR*	CAP0581024LBL*
	1/4"	Locking	1/4-20	CAP058025LA	CAP058025LAS*	CAP058025LB	CAP058025LAB*	CAP058025LG	CAP058025LBR*	CAP058025LBL*
3/4"	5/16"	Locking	5/16-18	CAP058LA	CAP058LAS*	CAP058LB*	CAP058LAB*	CAP058LG*	CAP058LBR*	CAP058LBL*
	3/8"	Locking	#10-24	CAP0751024LA	CAP0751024LAS*	CAP0751024LB	CAP0751024LAB*	CAP0751024LG*	CAP0751024LBR*	CAP0751024LBL*
7/8"	1/4"	Locking	1/4-20	CAP075025LA	CAP075025LAS*	CAP075025LB	CAP075025LAB*	CAP075025LG	CAP075025LBR*	CAP075025LBL*
	3/8"	Locking	5/16-18	CAP075LA	CAP075LAS*	CAP075LB	CAP075LAB*	CAP075LG	CAP075LBR*	CAP075LBL*
1"	1/4"	Locking	#10-24	CAP1001024LA	CAP1001024LAS*	CAP1001024LB	CAP1001024LAB*	CAP1001024LG*	CAP1001024LBR*	CAP1001024LBL*
	1/4"	Locking	1/4-20	CAP100025LA	CAP100025LAS*	CAP100025LB	CAP100025LAB*	CAP100025LG	CAP100025LBR*	CAP100025LBL*
	5/16"	Locking	5/16-18	CAP100LA	CAP100LAS*	CAP100LB	CAP100LAB*	CAP100LG	CAP100LBR*	CAP100LBL*
1-1/4"	5/16"	Locking	5/16-18	CAP125LA	CAP125LAS*	CAP125LB	CAP125LAB*	CAP125LG	CAP125LBR*	CAP125LBL*
1-1/2"	5/16"	Locking	5/16-18	CAP150LA	CAP150LAS*	CAP150LB	CAP150LAB*	CAP150LG	CAP150LBR*	CAP150LBL*
2"	1/2"	Locking	5/16-18	CAP200LA	CAP200LAS*	CAP200LB	CAP200LAB*	CAP200LG	CAP200LBR*	CAP200LBL*

### Round Caps

Diameter	Cap Height	Type	Thread	Aluminum Clear (A)	Aluminum Shiny (AS)	Aluminum Black (B)	Aluminum Bronze (AB)	Aluminum Gold (G)	Aluminum Champagne (BR)	Aluminum Blue (BL)
1"	1/8"	Rounded	5/16-18	CAP100RA	CAP100RAS*	CAP100RB	CAP100RAB*	CAP100RG	CAP100RBR*	CAP100RBL*
1-1/4"	1/8"	Rounded	5/16-18	CAP125RA	CAP125RAS*	CAP125RB	CAP125RAB*	CAP125RG	CAP125RBR*	CAP125RBL*
1-1/2"	1/8"	Rounded	5/16-18	CAP150RA	CAP150RAS*	CAP150RB	CAP150RAB*	CAP150RG	CAP150RBR*	CAP150RBL*

### Flat Caps

(\*) Available upon request minimum order quantity 100

Aluminum Copper (CP)	Aluminum Green (GN)	Aluminum Dark Green (DGN)	Aluminum Titanium (T)	Aluminum Pink (RP)	Aluminum Purple (PL)	Aluminum Red (RD)	Aluminum Tan (TAN)	Stainless Steel Brushed (SS)	Stainless Steel Polished (SP)
CAP025CP*	CAP025GN*	CAP025DGN*	CAP025T*	CAP025RP*	CAP025PL*	CAP025RD*	CAP025TAN*	CAP025SS	CAP025SP
CAP038CP*	CAP038GN*	CAP038DGN*	CAP038T*	CAP038RP*	CAP038PL*	CAP038RD*	CAP038TAN*	CAP038SS	CAP038SP
CAP050CP*	CAP050GN*	CAP050DGN*	CAP050T*	CAP050RP*	CAP050PL*	CAP050RD*	CAP050TAN*	CAP050SS	CAP050SP
CAP0581024CP*	CAP0581024GN*	CAP0581024DGN*	CAP0581024T*	CAP0581024RP*	CAP0581024PL*	CAP0581024RD*	CAP0581024TAN*	CAP0581024SS	CAP0581024SP
CAP058025CP*	CAP058025GN*	CAP058025DGN*	CAP058025T*	CAP058025RP*	CAP058025PL*	CAP058025RD*	CAP058025TAN*	CAP058025SS	CAP058025SP
CAP058CP*	CAP058GN*	CAP058DGN*	CAP058T*	CAP058RP*	CAP058PL*	CAP058RD*	CAP058TAN*	CAP058SS	CAP058SP
CAP0751024CP*	CAP0751024GN*	CAP0751024DGN*	CAP0751024T*	CAP0751024RP*	CAP0751024PL*	CAP0751024RD*	CAP0751024TAN*	CAP0751024SS	CAP0751024SP
CAP075025CP*	CAP075025GN*	CAP075025DGN*	CAP075025T*	CAP075025RP*	CAP075025PL*	CAP075025RD*	CAP075025TAN*	CAP075025SS	CAP075025SP
CAP075CP*	CAP075GN*	CAP075DGN*	CAP075T*	CAP075RP*	CAP075PL*	CAP075RD*	CAP075TAN*	CAP075SS	CAP075SP
CAP078025CP*	CAP078025GN*	CAP078025DGN*	CAP078025T*	CAP078025RP*	CAP078025PL*	CAP078025RD*	CAP078025TAN*	CAP078025SS	CAP078025SP
CAP1001024CP*	CAP1001024GN*	CAP1001024DGN*	CAP1001024T*	CAP1001024RP*	CAP1001024PL*	CAP1001024RD*	CAP1001024TAN*	CAP1001024SS	CAP1001024SP
CAP100025CP*	CAP100025GN*	CAP100025DGN*	CAP100025T*	CAP100025RP*	CAP100025PL*	CAP100025RD*	CAP100025TAN*	CAP100025SS	CAP100025SP
CAP100CP*	CAP100GN*	CAP100DGN*	CAP100T*	CAP100RP*	CAP100PL*	CAP100RD*	CAP100TAN*	CAP100SS	CAP100SP
CAP125CP*	CAP125GN*	CAP125DGN*	CAP125T*	CAP125RP*	CAP125PL*	CAP125RD*	CAP125TAN*	CAP125SS	CAP125SP
CAP150CP*	CAP150GN*	CAP150DGN*	CAP150T*	CAP150RP*	CAP150PL*	CAP150RD*	CAP150TAN*	CAP150SS	CAP150SP
CAP200CP*	CAP200GN*	CAP200DGN*	CAP200T*	CAP200RP*	CAP200PL*	CAP200RD*	CAP200TAN*	CAP200SS	CAP200SP

Aluminum Copper (CP)	Aluminum Green (GN)	Aluminum Dark Green (DGN)	Aluminum Titanium (T)	Aluminum Pink (RP)	Aluminum Purple (PL)	Aluminum Red (RD)	Aluminum Tan (TAN)	Stainless Steel Brushed (SS)	Stainless Steel Polished (SP)
CAP038LCP*	CAP038LGN*	CAP038LDGN*	CAP038LT*	CAP038LRP*	CAP038LPL*	CAP038LRD*	CAP038LTAN*	CAP038LSS*	CAP038LSP*
CAP050LCP*	CAP050LGN*	CAP050LDGN*	CAP050LT*	CAP050LRP*	CAP050LPL*	CAP050LRD*	CAP050LTAN*	CAP050LSS	CAP050LSP*
CAP0581024LCP*	CAP0581024LGN*	CAP0581024LDGN*	CAP0581024LT*	CAP0581024LRP*	CAP0581024LPL*	CAP0581024LRD*	CAP0581024LTAN*	CAP0581024LSS	CAP0581024LSP
CAP058025LCP*	CAP058025LGN*	CAP058025LDGN*	CAP058025LT*	CAP058025LRP*	CAP058025LPL*	CAP058025LRD*	CAP058025LTAN*	CAP058025LSS	CAP058025LSP*
CAP058LCP*	CAP058LGN*	CAP058LDGN*	CAP058LT*	CAP058LRP*	CAP058LPL*	CAP058LRD*	CAP058LTAN*	CAP058LSS	CAP058LSP*
CAP0751024LCP*	CAP0751024LGN*	CAP0751024LDGN*	CAP0751024LT*	CAP0751024LRP*	CAP0751024LPL*	CAP0751024LRD*	CAP0751024LTAN*	CAP0751024LSS	CAP0751024LSP
CAP075025LCP*	CAP075025LGN*	CAP075025LDGN*	CAP075025LT*	CAP075025LRP*	CAP075025LPL*	CAP075025LRD*	CAP075025LTAN*	CAP075025LSS	CAP075025LSP
CAP075LCP*	CAP075LGN*	CAP075LDGN*	CAP075LT*	CAP075LRP*	CAP075LPL*	CAP075LRD*	CAP075LTAN*	CAP075LSS	CAP075LSP
CAP078025LCP*	CAP078025LGN*	CAP078025LDGN*	CAP078025LT*	CAP078025LRP*	CAP078025LPL*	CAP078025LRD*	CAP078025LTAN*	CAP078025LSS	CAP078025LSP
CAP1001024LCP*	CAP1001024LGN*	CAP1001024LDGN*	CAP1001024LT*	CAP1001024LRP*	CAP1001024LPL*	CAP1001024LRD*	CAP1001024LTAN*	CAP1001024LSS	CAP1001024LSP
CAP100025LCP*	CAP100025LGN*	CAP100025LDGN*	CAP100025LT*	CAP100025LRP*	CAP100025LPL*	CAP100025LRD*	CAP100025LTAN*	CAP100025LSS	CAP100025LSP
CAP100LCP*	CAP100LGN*	CAP100LDGN*	CAP100LT*	CAP100LRP*	CAP100LPL*	CAP100LRD*	CAP100LTAN*	CAP100LSS	CAP100LSP
CAP125LCP*	CAP125LGN*	CAP125LDGN*	CAP125LT*	CAP125LRP*	CAP125LPL*	CAP125LRD*	CAP125LTAN*	CAP125LSS	CAP125LSP
CAP150LCP*	CAP150LGN*	CAP150LDGN*	CAP150LT*	CAP150LRP*	CAP150LPL*	CAP150LRD*	CAP150LTAN*	CAP150LSS	CAP150LSP
CAP200LCP*	CAP200LGN*	CAP200LDGN*	CAP200LT*	CAP200LRP*	CAP200LPL*	CAP200LRD*	CAP200LTAN*	CAP200LSS	CAP200LSP*

Aluminum Copper (CP)	Aluminum Green (GN)	Aluminum Dark Green (DGN)	Aluminum Titanium (T)	Aluminum Pink (RP)	Aluminum Purple (PL)	Aluminum Red (RD)	Aluminum Tan (TAN)	Stainless Steel Brushed (SS)	Stainless Steel Polished (SP)
CAP100RCP*	CAP100RCGN*	CAP100RDGN*	CAP100RT*	CAP100RCP*	CAP100RPL*	CAP100RRD*	CAP100RTAN*	CAP100RSS	CAP100RSP
CAP125RCP*	CAP125RCGN*	CAP125RDGN*	CAP125RT*	CAP125RCP*	CAP125RPL*	CAP125RRD*	CAP125RTAN*	CAP125RSS	CAP125RSP
CAP150RCP*	CAP150RCGN*	CAP150RDGN*	CAP150RT*	CAP150RCP*	CAP150RPL*	CAP150RRD*	CAP150RTAN*	CAP150RSS	CAP150RSP

## Hex Caps

- Product** | Hex Caps
- Unique Features** | Indoor & Outdoor Use  
Easily Change Out Signs  
4 Different Finish  
Elegant Look
- Area Of Use** | Signage  
Display  
Advertising
- Additional Details** | Hexagon Shape



Size	Height	Thread	Clear (A)	Black (B)	Gold (G)	Champagne (BR)
3/4"			CAP075HXA	CAP075HXB	CAP075HXG	CAP075HXBR
1"	3/8"	5/16-18	CAP100HXA	CAP100HXB	CAP100HXG	CAP100HXBR
1-1/4"			CAP125HXA	CAP125HXB	CAP125HXG	CAP125HXBR

## Multi-Mount Hardware

- Easily change out sign designs
- Use with our customizable line
- Pick the correct barrel
- Pick the correct hardware for the first layer
- Pick the correct hardware for the second layer
- 1/4-20 and 5/16-18 threads available

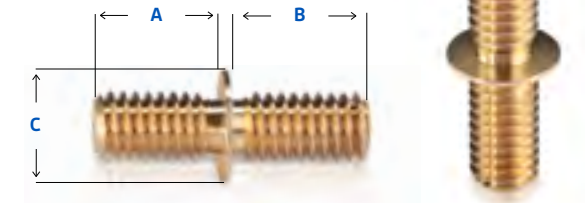
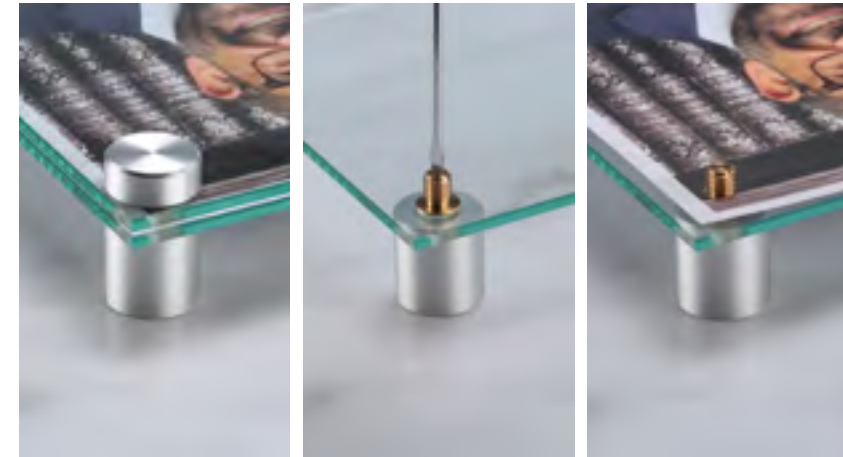
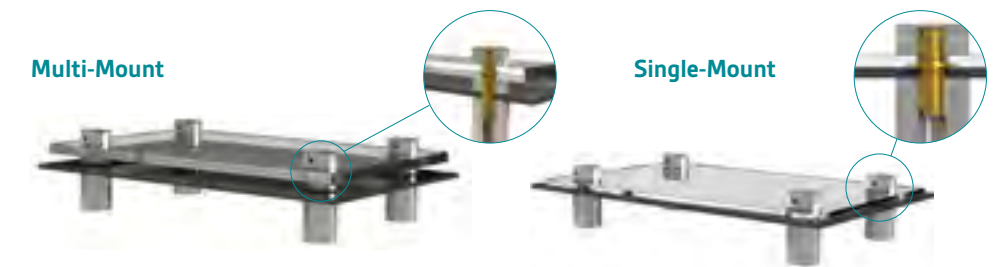

Length A	Length B	Diameter C	Material	1/4-20	5/16-18
1/8"	1/8"			MMH1420-01	MMH516-01
1/8"	1/4"			MMH1420-02	MMH516-02
1/8"	5/16"			MMH1420-03	MMH516-03
1/8"	3/8"			MMH1420-04	MMH516-04
1/8"	1/2"			MMH1420-05	MMH516-05
1/4"	1/4"			MMH1420-06	MMH516-06
1/4"	5/16"	1/2"	Brass	MMH1420-07	MMH516-07
1/4"	3/8"			MMH1420-08	MMH516-08
1/4"	1/2"			MMH1420-09	MMH516-09
5/16"	5/16"			MMH1420-10	MMH516-10
5/16"	3/8"			MMH1420-11	MMH516-11
5/16"	1/2"			MMH1420-12	MMH516-12
3/8"	3/8"			MMH1420-13	MMH516-13
3/8"	1/2"			MMH1420-14	MMH516-14

## Conversion Set Screws

Technical Information	Thread Size	Material	Length	SKU
	5/16-18 to 1/4-20		9/16"	CSC4
	5/16-18 to 1/4-20		7/8"	CSC1
	5/16-18 to 1/4-20	Brass	1-5/16"	CSC2
	5/16-18 to 1/4-20		1-13/16"	CSC3
	5/16-18 to 1/4-20		3-1/16"	CSC5



Barrels

Diameter	Barrel Height	Thread	Tapped Length							
				Aluminum Clear (A)	Aluminum Shiny (AS)	Aluminum Black (B)	Aluminum Gold (G)	Aluminum Bronze (AB)	Aluminum Champagne (BR)	Aluminum Blue (BL)
1/4"	1/4"	#6-32	Thru	S025-025A	S025-025AS*	S025-025B	S025-025G	S025-025AB*	S025-025BR*	S025-025BL*
	1/2"	#6-32	Thru	S025-050A	S025-050AS*	S025-050B	S025-050G	S025-050AB*	S025-050BR*	S025-050BL*
	3/4"	#6-32	Thru	S025-075A	S025-075AS*	S025-075B	S025-075G	S025-075AB*	S025-075BR*	S025-075BL*
	1"	#6-32	Thru	S025-100A	S025-100AS*	S025-100B	S025-100G	S025-100AB*	S025-100BR*	S025-100BL*
3/8"	1/4"	#10-24	Thru	S038-025A	S038-025AS*	S038-025B	S038-025G*	S038-025AB*	S038-025BR*	S038-025BL*
	1/2"	#10-24	Thru	S038-050A	S038-050AS*	S038-050B	S038-050G	S038-050AB*	S038-050BR*	S038-050BL*
	3/4"	#10-24	Thru	S038-075A	S038-075AS*	S038-075B	S038-075G	S038-075AB*	S038-075BR*	S038-075BL*
	1"	#10-24	Thru	S038-100A	S038-100AS*	S038-100B	S038-100G	S038-100AB*	S038-100BR*	S038-100BL*
1/2"	1/4"	#10-24	Thru	S050-025A	S050-025AS*	S050-025B*	S050-025G*	S050-025AB*	S050-025BR*	S050-025BL*
	1/2"	#10-24	Thru	S050-050A	S050-050AS*	S050-050B	S050-050G	S050-050AB*	S050-050BR*	S050-050BL*
	3/4"	#10-24	Thru	S050-075A	S050-075AS*	S050-075B	S050-075G	S050-075AB*	S050-075BR*	S050-075BL*
	1"	#10-24	Thru	S050-100A	S050-100AS*	S050-100B	S050-100G	S050-100AB*	S050-100BR*	S050-100BL*
	1-1/2"	#10-24	Thru	S050-150A	S050-150AS*	S050-150B	S050-150G	S050-150AB*	S050-150BR*	S050-150BL*
	2"	#10-24	Thru	S050-200A	S050-200AS*	S050-200B	S050-200G	S050-200AB*	S050-200BR*	S050-200BL*
	5"	#10-24	1" Both Ends	S050-500A	S050-500AS*	S050-500B*	S050-500G*	S050-500AB*	S050-500BR*	S050-500BL*
	7"	#10-24	1" Both Ends	S050-700A	S050-700AS*	S050-700B*	S050-700G*	S050-700AB*	S050-700BR*	S050-700BL*

\* Available upon request minimum order quantity 100.

Barrels

(\*) Available upon request minimum order quantity 100

									
Aluminum Copper (CP)	Aluminum Green (GN)	Aluminum Dark Green (DGN)	Aluminum Titanium (T)	Aluminum Pink (RP)	Aluminum Purple (PL)	Aluminum Red (RD)	Aluminum Tan (TAN)	Stainless Steel Brushed (SS)	Stainless Steel Polished (SP)
S025-025CP*	S025-025GN*	S025-025DGN*	S025-025T*	S025-025RP*	S025-025PL*	S025-025RD*	S025-025TAN*	S025-025SS	S025-025SP
S025-050CP*	S025-050GN*	S025-050DGN*	S025-050T*	S025-050RP*	S025-050PL*	S025-050RD*	S025-050TAN*	S025-050SS	S025-050SP
S025-075CP*	S025-075GN*	S025-075DGN*	S025-075T*	S025-075RP*	S025-075PL*	S025-075RD*	S025-075TAN*	S025-075SS	S025-075SP*
S025-100CP*	S025-100GN*	S025-100DGN*	S025-100T*	S025-100RP*	S025-100PL*	S025-100RD*	S025-100TAN*	S025-100SS	S025-100SP*
S038-025CP*	S038-025GN*	S038-025DGN*	S038-025T*	S038-025RP*	S038-025PL*	S038-025RD*	S038-025TAN*	S038-025SS*	S038-025SP*
S038-050CP*	S038-050GN*	S038-050DGN*	S038-050T*	S038-050RP*	S038-050PL*	S038-050RD*	S038-050TAN*	S038-050SS	S038-050SP
S038-075CP*	S038-075GN*	S038-075DGN*	S038-075T*	S038-075RP*	S038-075PL*	S038-075RD*	S038-075TAN*	S038-075SS	S038-075SP
S038-100CP*	S038-100GN*	S038-100DGN*	S038-100T*	S038-100RP*	S038-100PL*	S038-100RD*	S038-100TAN*	S038-100SS	S038-100SP
S050-025CP*	S050-025GN*	S050-025DGN*	S050-025T*	S050-025RP*	S050-025PL*	S050-025RD*	S050-025TAN*	S050-025SS	S050-025SP*
S050-050CP*	S050-050GN*	S050-050DGN*	S050-050T*	S050-050RP*	S050-050PL*	S050-050RD*	S050-050TAN*	S050-050SS	S050-050SP
S050-075CP*	S050-075GN*	S050-075DGN*	S050-075T*	S050-075RP*	S050-075PL*	S050-075RD*	S050-075TAN*	S050-075SS	S050-075SP*
S050-100CP*	S050-100GN*	S050-100DGN*	S050-100T*	S050-100RP*	S050-100PL*	S050-100RD*	S050-100TAN*	S050-100SS	S050-100SP*
S050-150CP*	S050-150GN*	S050-150DGN*	S050-150T*	S050-150RP*	S050-150PL*	S050-150RD*	S050-150TAN*	S050-150SS	S050-150SP*
S050-200CP*	S050-200GN*	S050-200DGN*	S050-200T*	S050-200RP*	S050-200PL*	S050-200RD*	S050-200TAN*	S050-200SS	S050-200SP*
S050-500CP*	S050-500GN*	S050-500DGN*	S050-500T*	S050-500RP*	S050-500PL*	S050-500RD*	S050-500TAN*	S050-500SS*	S050-500SP*
S050-700CP*	S050-700GN*	S050-700DGN*	S050-700T*	S050-700RP*	S050-700PL*	S050-700RD*	S050-700TAN*	S050-700SS*	S050-700SP*

\* Available upon request minimum order quantity 100.

Barrels

Diameter	Barrel Height	Thread	Tapped Length							
				Aluminum Clear (A)	Aluminum Shiny (AS)	Aluminum Black (B)	Aluminum Gold (G)	Aluminum Bronze (AB)	Aluminum Champagne (BR)	Aluminum Blue (BL)
5/8"	1/4"	#10-24	Thru	S058-025-1024A	S058-025-1024AS*	S058-025-1024B	S058-025-1024G*	S058-025-1024AB*	S058-025-1024BR*	S058-025-1024BL*
	1/4"	1/4-20	Thru	S058-02525A	S058-02525AS*	S058-02525B	S058-02525G*	S058-02525AB*	S058-02525BR*	S058-02525BL*
	1/4"	5/16-18	Thru	S058-025A	S058-025AS*	S058-025B*	S058-025G*	S058-025AB*	S058-025BR*	S058-025BL*
	1/2"	#10-24	Thru	S058-050-1024A	S058-050-1024AS*	S058-050-1024B	S058-050-1024G*	S058-050-1024AB*	S058-050-1024BR*	S058-050-1024BL*
	1/2"	1/4-20	Thru	S058-05025A	S058-05025AS*	S058-05025B	S058-05025G	S058-05025AB*	S058-05025BR*	S058-05025BL*
	1/2"	5/16-18	Thru	S058-050A	S058-050AS*	S058-050B	S058-050G	S058-050AB*	S058-050BR*	S058-050BL*
	3/4"	#10-24	Thru	S058-075-1024A	S058-075-1024AS*	S058-075-1024B	S058-075-1024G*	S058-075-1024AB*	S058-075-1024BR*	S058-075-1024BL*
	3/4"	1/4-20	Thru	S058-07525A	S058-07525AS*	S058-07525B	S058-07525G	S058-07525AB*	S058-07525BR*	S058-07525BL*
	3/4"	5/16-18	Thru	S058-075A	S058-075AS*	S058-075B	S058-075G	S058-075AB*	S058-075BR*	S058-075BL*
	1"	#10-24	Thru	S058-100-1024A	S058-100-1024AS*	S058-100-1024B	S058-100-1024G*	S058-100-1024AB*	S058-100-1024BR*	S058-100-1024BL*
	1"	1/4-20	Thru	S058-10025A	S058-10025AS*	S058-10025B	S058-10025G	S058-10025AB*	S058-10025BR*	S058-10025BL*
	1"	5/16-18	Thru	S058-100A	S058-100AS*	S058-100B	S058-100G	S058-100AB*	S058-100BR*	S058-100BL*
	1-1/2"	1/4-20	Thru	S058-15025A	S058-15025AS*	S058-15025B	S058-15025G	S058-15025AB*	S058-15025BR*	S058-15025BL*
	1-1/2"	5/16-18	Thru	S058-150A	S058-150AS*	S058-150B	S058-150G	S058-150AB*	S058-150BR*	S058-150BL*
	2"	1/4-20	Thru	S058-20025A	S058-20025AS*	S058-20025B	S058-20025G	S058-20025AB*	S058-20025BR*	S058-20025BL*
	2"	5/16-18	Thru	S058-200A	S058-200AS*	S058-200B	S058-200G	S058-200AB*	S058-200BR*	S058-200BL*
3"	1/4-20	1" Both Ends	S058-30025A	S058-30025AS*	S058-30025B	S058-30025G	S058-30025AB*	S058-30025BR*	S058-30025BL*	
3"	5/16-18	1" Both Ends	S058-300A	S058-300AS*	S058-300B	S058-300G	S058-300AB*	S058-300BR*	S058-300BL*	

\* Available upon request minimum order quantity 100.

Barrels

(\* Available upon request minimum order quantity 100)

									
Aluminum Copper (CP)	Aluminum Green (GN)	Aluminum Dark Green (DGN)	Aluminum Titanium (T)	Aluminum Pink (RP)	Aluminum Purple (PL)	Aluminum Red (RD)	Aluminum Tan (TAN)	Stainless Steel Brushed (SS)	Stainless Steel Polished (SP)
S058-025-1024CP*	S058-025-1024GN*	S058-025-1024DGN*	S058-025-1024T*	S058-025-1024RP*	S058-025-1024PL*	S058-025-1024RD*	S058-025-1024TAN*	S058-025-1024SS	S058-025-1024SP
S058-02525CP*	S058-02525GN*	S058-02525DGN*	S058-02525T*	S058-02525RP*	S058-02525PL*	S058-02525RD*	S058-02525TAN*	S058-02525SS	S058-02525SP*
S058-025CP*	S058-025GN*	S058-025DGN*	S058-025T*	S058-025RP*	S058-025PL*	S058-025RD*	S058-025TAN*	S058-025SS	S058-025SP*
S058-025-1024CP*	S058-025-1024GN*	S058-025-1024DGN*	S058-025-1024T*	S058-025-1024RP*	S058-025-1024PL*	S058-025-1024RD*	S058-025-1024TAN*	S058-025-1024SS	S058-025-1024SP
S058-05025CP*	S058-05025GN*	S058-05025DGN*	S058-05025T*	S058-05025RP*	S058-05025PL*	S058-05025RD*	S058-05025TAN*	S058-05025SS	S058-05025SP
S058-050CP*	S058-050GN*	S058-050DGN*	S058-050T*	S058-050RP*	S058-050PL*	S058-050RD*	S058-050TAN*	S058-050SS	S058-050SP
S058-050-1024CP*	S058-050-1024GN*	S058-050-1024DGN*	S058-050-1024T*	S058-050-1024RP*	S058-050-1024PL*	S058-050-1024RD*	S058-050-1024TAN*	S058-050-1024SS	S058-050-1024SP
S058-07525CP*	S058-07525GN*	S058-07525DGN*	S058-07525T*	S058-07525RP*	S058-07525PL*	S058-07525RD*	S058-07525TAN*	S058-07525SS	S058-07525SP
S058-075CP*	S058-075GN*	S058-075DGN*	S058-075T*	S058-075RP*	S058-075PL*	S058-075RD*	S058-075TAN*	S058-075SS	S058-075SP
S058-075-1024CP*	S058-075-1024GN*	S058-075-1024DGN*	S058-075-1024T*	S058-075-1024RP*	S058-075-1024PL*	S058-075-1024RD*	S058-075-1024TAN*	S058-075-1024SS	S058-075-1024SP
S058-10025CP*	S058-10025GN*	S058-10025DGN*	S058-10025T*	S058-10025RP*	S058-10025PL*	S058-10025RD*	S058-10025TAN*	S058-10025SS	S058-10025SP
S058-100CP*	S058-100GN*	S058-100DGN*	S058-100T*	S058-100RP*	S058-100PL*	S058-100RD*	S058-100TAN*	S058-100SS	S058-100SP
S058-15025CP*	S058-15025GN*	S058-15025DGN*	S058-15025T*	S058-15025RP*	S058-15025PL*	S058-15025RD*	S058-15025TAN*	S058-15025SS	S058-15025SP
S058-150CP*	S058-150GN*	S058-150DGN*	S058-150T*	S058-150RP*	S058-150PL*	S058-150RD*	S058-150TAN*	S058-150SS	S058-150SP
S058-20025CP*	S058-20025GN*	S058-20025DGN*	S058-20025T*	S058-20025RP*	S058-20025PL*	S058-20025RD*	S058-20025TAN*	S058-20025SS	S058-20025SP
S058-200CP*	S058-200GN*	S058-200DGN*	S058-200T*	S058-200RP*	S058-200PL*	S058-200RD*	S058-200TAN*	S058-200SS	S058-200SP
S058-30025CP*	S058-30025GN*	S058-30025DGN*	S058-30025T*	S058-30025RP*	S058-30025PL*	S058-30025RD*	S058-30025TAN*	S058-30025SS	S058-30025SP
S058-300CP*	S058-300GN*	S058-300DGN*	S058-300T*	S058-300RP*	S058-300PL*	S058-300RD*	S058-300TAN*	S058-300SS	S058-300SP*

\* Available upon request minimum order quantity 100.



Barrels

Diameter	Barrel Height	Thread	Tapped Length							
				Aluminum Clear (A)	Aluminum Shiny (AS)	Aluminum Black (B)	Aluminum Gold (G)	Aluminum Bronze (AB)	Aluminum Champagne (BR)	Aluminum Blue (BL)
3/4"	1/4"	#10-24	Thru	S075-025-1024A	S075-025-1024AS*	S075-025-1024B	S075-025-1024G*	S075-025-1024AB*	S075-025-1024BR*	S075-025-1024BL*
	1/4"	1/4-20	Thru	S075-02525A	S075-02525AS*	S075-02525B*	S075-02525G*	S075-02525AB*	S075-02525BR*	S075-02525BL*
	1/4"	5/16-18	Thru	S075-025A	S075-025AS*	S075-025B*	S075-025G*	S075-025AB*	S075-025BR*	S075-025BL*
	1/2"	#10-24	Thru	S075-050-1024A	S075-050-1024AS*	S075-050-1024B	S075-050-1024G*	S075-050-1024AB*	S075-050-1024BR*	S075-050-1024BL*
	1/2"	1/4-20	Thru	S075-05025A	S075-05025AS*	S075-05025B	S075-05025G	S075-05025AB*	S075-05025BR*	S075-05025BL*
	1/2"	5/16-18	Thru	S075-050A	S075-050AS*	S075-050B	S075-050G	S075-050AB*	S075-050BR*	S075-050BL*
	3/4"	#10-24	Thru	S075-075-10024A*	S075-075-10024AS*	S075-075-10024B*	S075-075-10024G*	S075-075-10024AB*	S075-075-10024BR*	S075-075-10024BL*
	3/4"	5/16-18	Thru	S075-075A	S075-075AS*	S075-075B	S075-075G	S075-075AB*	S075-075BR*	S075-075BL*
	1"	#10-24	Thru	S075-100-10024A*	S075-100-10024AS*	S075-100-10024B*	S075-100-10024G*	S075-100-10024AB*	S075-100-10024BR*	S075-100-10024BL*
	1"	1/4-20	Thru	S075-10025A	S075-10025AS*	S075-10025B	S075-10025G	S075-10025AB*	S075-10025BR*	S075-10025BL*
3/4"	1"	5/16-18	Thru	S075-100A	S075-100AS*	S075-100B	S075-100G	S075-100AB*	S075-100BR*	S075-100BL*
	1-1/2"	1/4-20	Thru	S075-15025A	S075-15025AS*	S075-15025B	S075-15025G	S075-15025AB*	S075-15025BR*	S075-15025BL*
	1-1/2"	5/16-18	Thru	S075-150A	S075-150AS*	S075-150B	S075-150G	S075-150AB*	S075-150BR*	S075-150BL*
	2"	1/4-20	Thru	S075-20025A	S075-20025AS*	S075-20025B	S075-20025G	S075-20025AB*	S075-20025BR*	S075-20025BL*
	2"	5/16-18	Thru	S075-200A	S075-200AS*	S075-200B	S075-200G	S075-200AB*	S075-200BR*	S075-200BL*
	2-1/2"	5/16-18	1" Both Ends	S075-250A*	S075-250AS*	S075-250B*	S075-250G*	S075-250AB*	S075-250BR*	S075-250BL*
	2-3/4"	5/16-18	1" Both Ends	S075-275A*	S075-275AS*	S075-275B*	S075-275G*	S075-275AB*	S075-275BR*	S075-275BL*
	3"	1/4-20	1" Both Ends	S075-30025A	S075-30025AS*	S075-30025B	S075-30025G	S075-30025AB*	S075-30025BR*	S075-30025BL*
	3"	5/16-18	1" Both Ends	S075-300A	S075-300AS*	S075-300B	S075-300G	S075-300AB*	S075-300BR*	S075-300BL*
	3-1/4"	5/16-18	1" Both Ends	S075-325A*	S075-325AS*	S075-325B*	S075-325G*	S075-325AB*	S075-325BR*	S075-325BL*
7/8"	4"	5/16-18	1" Both Ends	S075-400A	S075-400AS*	S075-400B*	S075-400G*	S075-400AB*	S075-400BR*	S075-400BL*
	1/2"	1/4-20	Thru	S078-05025A	S078-05025AS*	S078-05025B	S078-05025G	S078-05025AB*	S078-05025BR*	S078-05025BL*
	1"	1/4-20	Thru	S078-10025A	S078-10025AS*	S078-10025B	S078-10025G	S078-10025AB*	S078-10025BR*	S078-10025BL*
	1-1/2"	1/4-20	Thru	S078-15025A	S078-15025AS*	S078-15025B	S078-15025G	S078-15025AB*	S078-15025BR*	S078-15025BL*
	2"	1/4-20	Thru	S078-20025A	S078-20025AS*	S078-20025B	S078-20025G	S078-20025AB*	S078-20025BR*	S078-20025BL*
	3"	1/4-20	Thru	S078-30025A	S078-30025AS*	S078-30025B	S078-30025G	S078-30025AB*	S078-30025BR*	S078-30025BL*

\* Available upon request minimum order quantity 100.

Barrels

(\* Available upon request minimum order quantity 100)

									
Aluminum Copper (CP)	Aluminum Green (GN)	Aluminum Dark Green (DGN)	Aluminum Titanium (T)	Aluminum Pink (RP)	Aluminum Purple (PL)	Aluminum Red (RD)	Aluminum Tan (TAN)	Stainless Steel Brushed (SS)	Stainless Steel Polished (SP)
S075-025-1024CP*	S075-025-1024GN*	S075-025-1024DGN*	S075-025-1024ST*	S075-025-1024RP*	S075-025-1024PL*	S075-025-1024RD*	S075-025-1024TAN*	S075-025-1024SS	S075-025-1024SP
S075-02525CP*	S075-02525GN*	S075-02525DGN*	S075-02525ST*	S075-02525RP*	S075-02525PL*	S075-02525RD*	S075-02525TAN*	S075-02525SS	S075-02525SP*
S075-025CP*	S075-025GN*	S075-025DGN*	S075-025ST*	S075-025RP*	S075-025PL*	S075-025RD*	S075-025TAN*	S075-025SS	S075-025SP*
S075-050-1024CP*	S075-050-1024GN*	S075-050-1024DGN*	S075-050-1024ST*	S075-050-1024RP*	S075-050-1024PL*	S075-050-1024RD*	S075-050-1024TAN*	S075-050-1024SS	S075-050-1024SP
S075-05025CP*	S075-05025GN*	S075-05025DGN*	S075-05025ST*	S075-05025RP*	S075-05025PL*	S075-05025RD*	S075-05025TAN*	S075-05025SS	S075-05025SP
S075-050CP*	S075-050GN*	S075-050DGN*	S075-050T*	S075-050RP*	S075-050PL*	S075-050RD*	S075-050TAN*	S075-050SS	S075-050SP
S075-075-10024CP*	S075-075-10024GN*	S075-075-10024DGN*	S075-075-10024T*	S075-075-10024RP*	S075-075-10024PL*	S075-075-10024RD*	S075-075-10024TAN*	S075-075-10024SS*	S075-075-10024SP*
S075-075CP*	S075-075GN*	S075-075DGN*	S075-075T*	S075-075RP*	S075-075PL*	S075-075RD*	S075-075TAN*	S075-075SS	S075-075SP
S075-100-10024CP*	S075-100-10024GN*	S075-100-10024DGN*	S075-100-10024T*	S075-100-10024RP*	S075-100-10024PL*	S075-100-10024RD*	S075-100-10024TAN*	S075-100-10024SS*	S075-100-10024SP*
S075-10025CP*	S075-10025GN*	S075-10025DGN*	S075-10025T*	S075-10025RP*	S075-10025PL*	S075-10025RD*	S075-10025TAN*	S075-10025SS	S075-10025SP
S075-100CP*	S075-100GN*	S075-100DGN*	S075-100T*	S075-100RP*	S075-100PL*	S075-100RD*	S075-100TAN*	S075-100SS	S075-100SP
S075-15025CP*	S075-15025GN*	S075-15025DGN*	S075-15025T*	S075-15025RP*	S075-15025PL*	S075-15025RD*	S075-15025TAN*	S075-15025SS	S075-15025SP
S075-150CP*	S075-150GN*	S075-150DGN*	S075-150T*	S075-150RP*	S075-150PL*	S075-150RD*	S075-150TAN*	S075-150SS	S075-150SP
S075-20025CP*	S075-20025GN*	S075-20025DGN*	S075-20025T*	S075-20025RP*	S075-20025PL*	S075-20025RD*	S075-20025TAN*	S075-20025SS	S075-20025SP
S075-200CP*	S075-200GN*	S075-200DGN*	S075-200T*	S075-200RP*	S075-200PL*	S075-200RD*	S075-200TAN*	S075-200SS	S075-200SP
S075-250CP*	S075-250GN*	S075-250DGN*	S075-250T*	S075-250RP*	S075-250PL*	S075-250RD*	S075-250TAN*	S075-250SS*	S075-250SP*
S075-275CP*	S075-275GN*	S075-275DGN*	S075-275T*	S075-275RP*	S075-275PL*	S075-275RD*	S075-275TAN*	S075-275SS*	S075-275SP*
S075-30025CP*	S075-30025GN*	S075-30025DGN*	S075-30025T*	S075-30025RP*	S075-30025PL*	S075-30025RD*	S075-30025TAN*	S075-30025SS	S075-30025SP
S075-300CP*	S075-300GN*	S075-300DGN*	S075-300T*	S075-300RP*	S075-300PL*	S075-300RD*	S075-300TAN*	S075-300SS	S075-300SP*
S075-325CP*	S075-325GN*	S075-325DGN*	S075-325T*	S075-325RP*	S075-325PL*	S075-325RD*	S075-325TAN*	S075-325SS*	S075-325SP*
S075-400CP*	S075-400GN*	S075-400DGN*	S075-400T*	S075-400RP*	S075-400PL*	S075-400RD*	S075-400TAN*	S075-400SS*	S075-400SP*
S078-05025CP*	S078-05025GN*	S078-05025DGN*	S078-05025T*	S078-05025RP*	S078-05025PL*	S078-05025RD*	S078-05025TAN*	S078-05025SS	S078-05025SP
S078-10025CP*	S078-10025GN*	S078-10025DGN*	S078-10025T*	S078-10025RP*	S078-10025PL*	S078-10025RD*	S078-10025TAN*	S078-10025SS	S078-10025SP
S078-15025CP*	S078-15025GN*	S078-15025DGN*	S078-15025T*	S078-15025RP*	S078-15025PL*	S078-15025RD*	S078-15025TAN*	S078-15025SS	S078-15025SP
S078-20025CP*	S078-20025GN*	S078-20025DGN*	S078-20025T*	S078-20025RP*	S078-20025PL*	S078-20025RD*	S078-20025TAN*	S078-20025SS	S078-20025SP
S078-30025CP*	S078-30025GN*	S078-30025DGN*	S078-30025T*	S078-30025RP*	S078-30025PL*	S078-30025RD*	S078-30025TAN*	S078-30025SS	S078-30025SP

\* Available upon request minimum order quantity 100.

Barrels

Diameter	Barrel Height	Thread	Tapped Length							
				Aluminum Clear (A)	Aluminum Shiny (AS)	Aluminum Black (B)	Aluminum Gold (G)	Aluminum Bronze (AB)	Aluminum Champagne (BR)	Aluminum Blue (BL)
1"	1/4"	#10-24	Thru	S100-025-1024A	S100-025-1024AS*	S100-025-1024B	S100-025-1024G*	S100-025-1024AB*	S100-025-1024BR*	S100-025-1024BL*
	1/4"	1/4-20	Thru	S100-02525A*	S100-02525AS*	S100-02525B*	S100-02525G*	S100-02525AB*	S100-02525BR*	S100-02525BL*
	1/4"	5/16-18	Thru	S100-025A	S100-025AS*	S100-025B*	S100-025G	S100-025AB*	S100-025BR*	S100-025BL*
	1/2"	#10-24	Thru	S100-050-1024A	S100-050-1024AS*	S100-050-1024B	S100-050-1024G*	S100-050-1024AB*	S100-050-1024BR*	S100-050-1024BL*
	1/2"	1/4-20	Thru	S100-05025A	S100-05025AS*	S100-05025B	S100-05025G	S100-05025AB*	S100-05025BR*	S100-05025BL*
	1/2"	5/16-18	Thru	S100-050A	S100-050AS*	S100-050B	S100-050G	S100-050AB*	S100-050BR*	S100-050BL*
	3/4"	#10-24	Thru	S100-075-1024A	S100-075-1024AS*	S100-075-1024B	S100-075-1024G*	S100-075-1024AB*	S100-075-1024BR*	S100-075-1024BL*
	3/4"	5/16-18	Thru	S100-075A	S100-075AS*	S100-075B	S100-075G	S100-075AB*	S100-075BR*	S100-075BL*
	1"	#10-24	Thru	S100-100-1024A	S100-100-1024AS*	S100-100-1024B	S100-100-1024G*	S100-100-1024AB*	S100-100-1024BR*	S100-100-1024BL*
	1"	1/4-20	Thru	S100-10025A	S100-10025AS*	S100-10025B	S100-10025G	S100-10025AB*	S100-10025BR*	S100-10025BL*
	1"	5/16-18	Thru	S100-100A	S100-100AS*	S100-100B	S100-100G	S100-100AB	S100-100BR*	S100-100BL*
	1-1/2"	1/4-20	Thru	S100-15025A	S100-15025AS*	S100-15025B	S100-15025G	S100-15025AB*	S100-15025BR*	S100-15025BL*
	1-1/2"	5/16-18	Thru	S100-150A	S100-150AS*	S100-150B	S100-150G	S100-150AB*	S100-150BR*	S100-150BL*
	2"	1/4-20	Thru	S100-20025A	S100-20025AS*	S100-20025B	S100-20025G	S100-20025AB*	S100-20025BR*	S100-20025BL*
	2"	5/16-18	Thru	S100-200A	S100-200AS*	S100-200B	S100-200G	S100-200AB*	S100-200BR*	S100-200BL*
	3"	1/4-20	1" Both Ends	S100-30025A	S100-30025AS*	S100-30025B	S100-30025G	S100-30025AB*	S100-30025BR*	S100-30025BL*
3"	5/16-18	1" Both Ends	S100-300A	S100-300AS*	S100-300B	S100-300G	S100-300AB*	S100-300BR*	S100-300BL*	
4"	5/16-18	1" Both Ends	S100-400A	S100-400AS*	S100-400B	S100-400G*	S100-400AB*	S100-400BR*	S100-400BL*	
6"	5/16-18	1" Both Ends	S100-600A	S100-600AS*	S100-600B*	S100-600G*	S100-600AB*	S100-600BR*	S100-600BL*	
8"	5/16-18	1" Both Ends	S100-800A	S100-800AS*	S100-800B*	S100-800G*	S100-800AB*	S100-800BR*	S100-800BL*	
10"	5/16-18	1" Both Ends	S100-1000A	S100-1000AS*	S100-1000B*	S100-1000G*	S100-1000AB*	S100-1000BR*	S100-1000BL*	
12"	5/16-18	1" Both Ends	S100-1200A	S100-1200AS*	S100-1200B*	S100-1200G*	S100-1200AB*	S100-1200BR*	S100-1200BL*	

\* Available upon request minimum order quantity 100.

Barrels

(\*) Available upon request minimum order quantity 100

									
Aluminum Copper (CP)	Aluminum Green (GN)	Aluminum Dark Green (DGN)	Aluminum Titanium (T)	Aluminum Pink (RP)	Aluminum Purple (PL)	Aluminum Red (RD)	Aluminum Tan (TAN)	Stainless Steel Brushed (SS)	Stainless Steel Polished (SP)
S100-025-1024CP*	S100-025-1024GN*	S100-025-1024DGN*	S100-025-1024T*	S100-025-1024RP*	S100-025-1024PL*	S100-025-1024RD*	S100-025-1024TAN*	S100-025-1024SS	S100-025-1024SP
S100-02525CP*	S100-02525GN*	S100-02525DGN*	S100-02525T*	S100-02525RP*	S100-02525PL*	S100-02525RD*	S100-02525TAN*	S100-02525SS	S100-02525SP*
S100-025CP*	S100-025GN*	S100-025DGN*	S100-025T*	S100-025RP*	S100-025PL*	S100-025RD*	S100-025TAN*	S100-025SS	S100-025SP*
S100-050-1024CP*	S100-050-1024GN*	S100-050-1024DGN*	S100-050-1024T*	S100-050-1024RP*	S100-050-1024PL*	S100-050-1024RD*	S100-050-1024TAN	S100-050-1024SS	S100-050-1024SP
S100-05025CP*	S100-05025GN*	S100-05025DGN*	S100-05025T*	S100-05025RP*	S100-05025PL*	S100-05025RD*	S100-05025TAN*	S100-05025SS	S100-05025SP
S100-050CP*	S100-050GN*	S100-050DGN*	S100-050T*	S100-050RP*	S100-050PL*	S100-050RD*	S100-050TAN*	S100-050SS	S100-050SP
S100-075-1024CP*	S100-075-1024GN*	S100-075-1024DGN*	S100-075-1024T*	S100-075-1024RP*	S100-075-1024PL*	S100-075-1024RD*	S100-075-1024TAN	S100-075-1024SS	S100-075-1024SP
S100-075CP*	S100-075GN*	S100-075DGN*	S100-075T*	S100-075RP*	S100-075PL*	S100-075RD*	S100-075TAN*	S100-075SS*	S100-075SP*
S100-100-1024CP*	S100-100-1024GN*	S100-100-1024DGN*	S100-100-1024T*	S100-100-1024RP*	S100-100-1024PL*	S100-100-1024RD*	S100-100-1024TAN	S100-100-1024SS	S100-100-1024SP
S100-10025CP*	S100-10025GN*	S100-10025DGN*	S100-10025T*	S100-10025RP*	S100-10025PL*	S100-10025RD*	S100-10025TAN*	S100-10025SS	S100-10025SP
S100-100CP*	S100-100GN*	S100-100DGN*	S100-100T*	S100-100RP*	S100-100PL*	S100-100RD*	S100-100TAN*	S100-100SS	S100-100SP
S100-15025CP*	S100-15025GN*	S100-15025DGN*	S100-15025T*	S100-15025RP*	S100-15025PL*	S100-15025RD*	S100-15025TAN*	S100-15025SS	S100-15025SP
S100-150CP*	S100-150GN*	S100-150DGN*	S100-150T*	S100-150RP*	S100-150PL*	S100-150RD*	S100-150TAN*	S100-150SS	S100-150SP
S100-20025CP*	S100-20025GN*	S100-20025DGN*	S100-20025T*	S100-20025RP*	S100-20025PL*	S100-20025RD*	S100-20025TAN*	S100-20025SS	S100-20025SP
S100-200CP*	S100-200GN*	S100-200DGN*	S100-200T*	S100-200RP*	S100-200PL*	S100-200RD*	S100-200TAN*	S100-200SS	S100-200SP
S100-30025CP*	S100-30025GN*	S100-30025DGN*	S100-30025T*	S100-30025RP*	S100-30025PL*	S100-30025RD*	S100-30025TAN*	S100-30025SS	S100-30025SP
S100-300CP*	S100-300GN*	S100-300DGN*	S100-300T*	S100-300RP*	S100-300PL*	S100-300RD*	S100-300TAN*	S100-300SS	S100-300SP*
S100-400CP*	S100-400GN*	S100-400DGN*	S100-400T*	S100-400RP*	S100-400PL*	S100-400RD*	S100-400TAN*	S100-400SS	S100-400SP
S100-600CP*	S100-600GN*	S100-600DGN*	S100-600DT*	S100-600RP*	S100-600PL*	S100-600RD*	S100-600TAN*	S100-600SS	S100-600SP
S100-800CP*	S100-800GN*	S100-800DGN*	S100-800DT*	S100-800RP*	S100-800PL*	S100-800RD*	S100-800TAN*	S100-800SS	S100-800SP
S100-1000CP*	S100-1000GN*	S100-1000DGN*	S100-1000DT*	S100-1000RP*	S100-1000PL*	S100-1000RD*	S100-1000TAN*	S100-1000SS	S100-1000SP
S100-1200CP*	S100-1200GN*	S100-1200DGN*	S100-1200DT*	S100-1200RP*	S100-1200PL*	S100-1200RD*	S100-1200TAN*	S100-1200SS	S100-1200SP

\* Available upon request minimum order quantity 100.



Barrels

Diameter	Barrel Height	Thread	Tapped Length							
				Aluminum Clear (A)	Aluminum Shiny (AS)	Aluminum Black (B)	Aluminum Gold (G)	Aluminum Bronze (AB)	Aluminum Champagne (BR)	Aluminum Blue (BL)
1-1/4"	1/4"	5/16-18	Thru	S125-025A	S125-025AS*	S125-025B	S125-025G	S125-025AB*	S125-025BR*	S125-025BL*
	1/2"	5/16-18	Thru	S125-050A	S125-050AS*	S125-050B	S125-050G	S125-050AB*	S125-050BR*	S125-050BL*
	5/8"	5/16-18	Thru	S125-058A	S125-058AS*	S125-058B	S125-058G	S125-058AB*	S125-058BR*	S125-058BL*
	1"	5/16-18	Thru	S125-100A	S125-100AS*	S125-100B	S125-100G	S125-100AB*	S125-100BR*	S125-100BL*
	1-1/2"	5/16-18	Thru	S125-150A	S125-150AS*	S125-150B	S125-150G	S125-150AB*	S125-150BR*	S125-150BL*
	2"	5/16-18	Thru	S125-200A	S125-200AS*	S125-200B	S125-200G	S125-200AB*	S125-200BR*	S125-200BL*
	3"	5/16-18	1" Both Ends	S125-300A	S125-300AS*	S125-300B	S125-300G	S125-300AB*	S125-300BR*	S125-300BL*
	4"	5/16-18	1" Both Ends	S125-400A	S125-400AS*	S125-400B	S125-400G	S125-400AB*	S125-400BR*	S125-400BL*
	5"	5/16-18	1" Both Ends	S125-500A	S125-500AS*	S125-500B	S125-500G	S125-500AB*	S125-500BR*	S125-500BL*
	6"	5/16-18	1" Both Ends	S125-600A	S125-600AS*	S125-600B	S125-600G	S125-600AB*	S125-600BR*	S125-600BL*
	7"	5/16-18	1" Both Ends	S125-700A	S125-700AS*	S125-700B	S125-700G	S125-700AB*	S125-700BR*	S125-700BL*
	8"	5/16-18	1" Both Ends	S125-800A	S125-800AS*	S125-800B	S125-800G	S125-800AB*	S125-800BR*	S125-800BL*
9"	5/16-18	1" Both Ends	S125-900A	S125-900AS*	S125-900B	S125-900G	S125-900AB*	S125-900BR*	S125-900BL*	
10"	5/16-18	1" Both Ends	S125-1000A	S125-1000AS*	S125-1000B	S125-1000G	S125-1000AB*	S125-1000BR*	S125-1000BL*	
12"	5/16-18	1" Both Ends	S125-1200A	S125-1200AS*	S125-1200B	S125-1200G	S125-1200AB*	S125-1200BR*	S125-1200BL*	
1-1/2"	1/4"	5/16-18	Thru	S150-025A*	S150-025AS*	S150-025B*	S150-025G*	S150-025AB*	S150-025BR*	S150-025BL*
	1/2"	5/16-18	Thru	S150-050A	S150-050AS*	S150-050B	S150-050G	S150-050AB*	S150-050BR*	S150-050BL*
	1"	5/16-18	Thru	S150-100A	S150-100AS*	S150-100B	S150-100G	S150-100AB*	S150-100BR*	S150-100BL*
	2"	5/16-18	Thru	S150-200A	S150-200AS*	S150-200B	S150-200G	S150-200AB*	S150-200BR*	S150-200BL*
	3"	5/16-18	1" Both Ends	S150-300A	S150-300AS*	S150-300B	S150-300G	S150-300AB*	S150-300BR*	S150-300BL*
	4"	5/16-18	1" Both Ends	S150-400A	S150-400AS*	S150-400B	S150-400G	S150-400AB*	S150-400BR*	S150-400BL*
2"	1/4"	5/16-18	Thru	S200-025A*	S200-025AS*	S200-025B*	S200-025G*	S200-025AB*	S200-025BR*	S200-025BL*
	1/2"	5/16-18	Thru	S200-050A	S200-050AS*	S200-050B	S200-050G	S200-050AB*	S200-050BR*	S200-050BL*
	1"	5/16-18	Thru	S200-100A	S200-100AS*	S200-100B	S200-100G	S200-100AB*	S200-100BR*	S200-100BL*
	2"	5/16-18	Thru	S200-200A	S200-200AS*	S200-200B	S200-200G	S200-200AB*	S200-200BR*	S200-200BL*
	3"	5/16-18	1" Both Ends	S200-300A	S200-300AS*	S200-300B	S200-300G	S200-300AB*	S200-300BR*	S200-300BL*
4"	5/16-18	1" Both Ends	S200-400A	S200-400AS*	S200-400B	S200-400G	S200-400AB*	S200-400BR*	S200-400BL*	

\* Available upon request minimum order quantity 100.

Barrels

(\*) Available upon request minimum order quantity 100

									
Aluminum Copper (CP)	Aluminum Green (GN)	Aluminum Dark Green (DGN)	Aluminum Titanium (T)	Aluminum Pink (RP)	Aluminum Purple (PL)	Aluminum Red (RD)	Aluminum Tan (TAN)	Stainless Steel Brushed (SS)	Stainless Steel Polished (SP)
S125-025CP*	S125-025GN*	S125-025DGN*	S125-025T*	S125-025RP*	S125-025PL*	S125-025RD*	S125-025TAN*	S125-025SS	S125-025SP
S125-050CP*	S125-050GN*	S125-050DGN*	S125-050T*	S125-050RP*	S125-050PL*	S125-050RD*	S125-050TAN*	S125-050SS	S125-050SP*
S125-058CP*	S125-058GN*	S125-058DGN*	S125-058T*	S125-058RP*	S125-058PL*	S125-058RD*	S125-058TAN*	S125-058SS	S125-058SP
S125-100CP*	S125-100GN*	S125-100DGN*	S125-100T*	S125-100RP*	S125-100PL*	S125-100RD*	S125-100TAN*	S125-100SS	S125-100SP
S125-150CP*	S125-150GN*	S125-150DGN*	S125-150T*	S125-150RP*	S125-150PL*	S125-150RD*	S125-150TAN*	S125-150SS	S125-150SP
S125-200CP*	S125-200GN*	S125-200DGN*	S125-200T*	S125-200RP*	S125-200PL*	S125-200RD*	S125-200TAN*	S125-200SS	S125-200SP
S125-300CP*	S125-300GN*	S125-300DGN*	S125-300T*	S125-300RP*	S125-300PL*	S125-300RD*	S125-300TAN*	S125-300SS*	S125-300SP*
S125-400CP*	S125-400GN*	S125-400DGN*	S125-400T*	S125-400RP*	S125-400PL*	S125-400RD*	S125-400TAN*	S125-400SS	S125-400SP
S125-500CP*	S125-500GN*	S125-500DGN*	S125-500T*	S125-500RP*	S125-500PL*	S125-500RD*	S125-500TAN*	S125-500SS*	S125-500SP*
S125-600CP*	S125-600GN*	S125-600DGN*	S125-600T*	S125-600RP*	S125-600PL*	S125-600RD*	S125-600TAN*	S125-600SS	S125-600SP
S125-700CP*	S125-700GN*	S125-700DGN*	S125-700T*	S125-700RP*	S125-700PL*	S125-700RD*	S125-700TAN*	S125-700SS*	S125-700SP*
S125-800CP*	S125-800GN*	S125-800DGN*	S125-800T*	S125-800RP*	S125-800PL*	S125-800RD*	S125-800TAN*	S125-800SS	S125-800SP
S125-900CP*	S125-900GN*	S125-900DGN*	S125-900T*	S125-900RP*	S125-900PL*	S125-900RD*	S125-900TAN*	S125-900SS*	S125-900SP*
S125-1000CP*	S125-1000GN*	S125-1000DGN*	S125-1000T*	S125-1000RP*	S125-1000PL*	S125-1000RD*	S125-1000TAN*	S125-1000SS	S125-1000SP
S125-1200CP*	S125-1200GN*	S125-1200DGN*	S125-1200T*	S125-1200RP*	S125-1200PL*	S125-1200RD*	S125-1200TAN*	S125-1200SS	S125-1200SP
S150-025CP*	S150-025GN*	S150-025DGN*	S150-025T*	S150-025RP*	S150-025PL*	S150-025RD*	S150-025TAN*	S150-025SS	S150-025SP*
S150-050CP*	S150-050GN*	S150-050DGN*	S150-050T*	S150-050RP*	S150-050PL*	S150-050RD*	S150-050TAN*	S150-050SS	S150-050SP
S150-100CP*	S150-100GN*	S150-100DGN*	S150-100T*	S150-100RP*	S150-100PL*	S150-100RD*	S150-100TAN*	S150-100SS	S150-100SP
S150-200CP*	S150-200GN*	S150-200DGN*	S150-200T*	S150-200RP*	S150-200PL*	S150-200RD*	S150-200TAN*	S150-200SS	S150-200SP
S150-300CP*	S150-300GN*	S150-300DGN*	S150-300T*	S150-300RP*	S150-300PL*	S150-300RD*	S150-300TAN*	S150-300SS*	S150-300SP*
S150-400CP*	S150-400GN*	S150-400DGN*	S150-400T*	S150-400RP*	S150-400PL*	S150-400RD*	S150-400TAN*	S150-400SS	S150-400SP
S150-600CP*	S150-600GN*	S150-600DGN*	S150-600T*	S150-600RP*	S150-600PL*	S150-600RD*	S150-600TAN*	S150-600SS	S150-600SP
S200-025CP*	S200-025GN*	S200-025DGN*	S200-025T*	S200-025RP*	S200-025PL*	S200-025RD*	S200-025TAN*	S200-025SS	S200-025SP*
S200-050CP*	S200-050GN*	S200-050DGN*	S200-050T*	S200-050RP*	S200-050PL*	S200-050RD*	S200-050TAN*	S200-050SS	S200-050SP
S200-100CP*	S200-100GN*	S200-100DGN*	S200-100T*	S200-100RP*	S200-100PL*	S200-100RD*	S200-100TAN*	S200-100SS	S200-100SP
S200-200CP*	S200-200GN*	S200-200DGN*	S200-200T*	S200-200RP*	S200-200PL*	S200-200RD*	S200-200TAN*	S200-200SS	S200-200SP
S200-300CP*	S200-300GN*	S200-300DGN*	S200-300T*	S200-300RP*	S200-300PL*	S200-300RD*	S200-300TAN*	S200-300SS*	S200-300SP*
S200-400CP*	S200-400GN*	S200-400DGN*	S200-400T*	S200-400RP*	S200-400PL*	S200-400RD*	S200-400TAN*	S200-400SS*	S200-400SP*

\* Available upon request minimum order quantity 100.

## Aluminum Square Caps and Barrels

- Wall mounted standoffs
- Designed from high quality aluminum
- Caps need your choice of stud length and don't forget your combination screws and anchors (page 51)

IDEAL FOR MULTI-MOUNT PROJECTS!

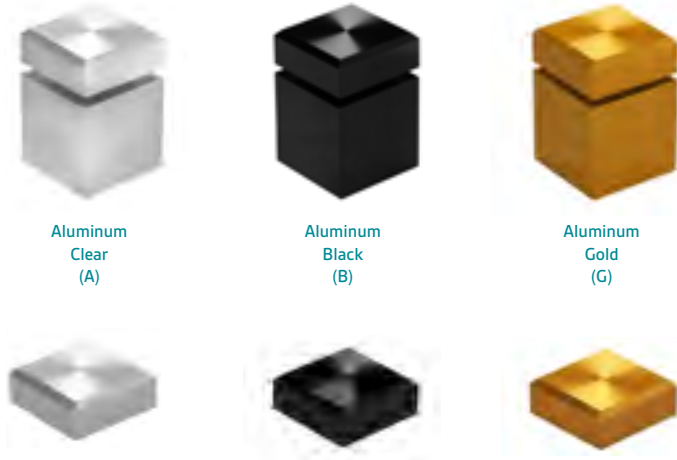

### Square Caps 5/16 – 18 Threaded

Diameter	Length	Clear (A)	Black (B)	Gold (G)
3/4"	3/4"	CAP075SQA	CAP075SQB	CAP075SQG
1"	1"	CAP100SQA	CAP100SQB	CAP100SQG



### Square Barrels 5/16 – 18 Threaded

Diameter	Length	Tapped	Clear (A)	Black (B)	Gold (G)
3/4"	3/4"	Thru	S075-075SQA	S075-075SQB	S075-075SQG
	1"	Thru	S075-100SQA	S075-100SQB	S075-100SQG
1"	3/4"	Thru	S100-075SQA	S100-075SQB	S100-075SQG
	1"	Thru	S100-100SQA	S100-100SQB	S100-100SQG

Use for drywall: screw HB5/16-125 and anchor ANC6, ANC6Z  
Use for concrete: screw HB5/16-125 and anchor ANC2

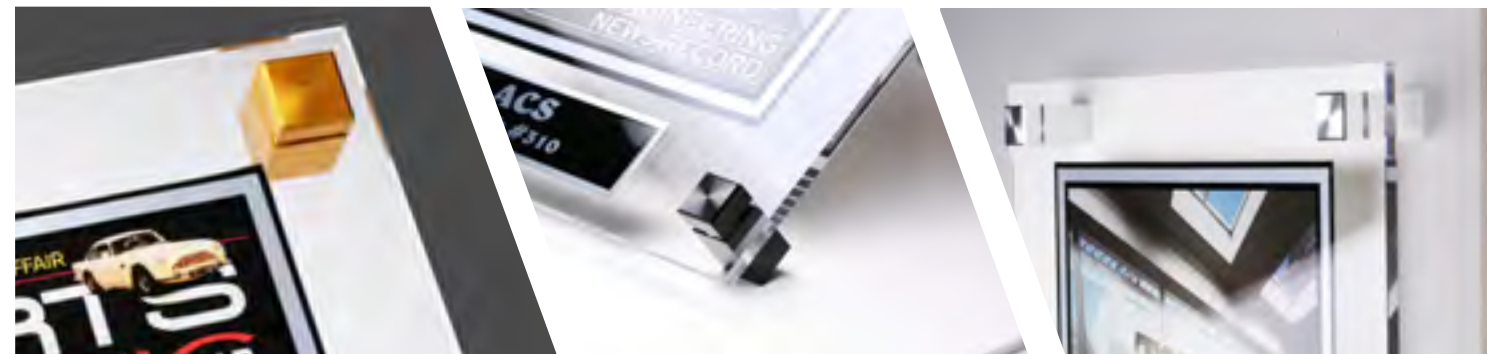

## Aluminum Hub for Customizable Standoffs

- Can hold 4 panels on the corner
- 3 Different diameters
- 3 Different material thickness's
- 2 Different Finishes
- Requires 2mm allen key

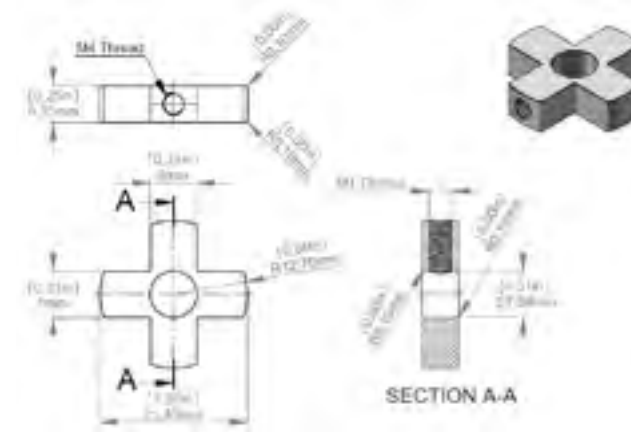

Diameter	Material Thickness Accepted	Aluminum Clear (A)	Aluminum Black (B)
1" 3/8" Material Hole Diameter	1/4"	H100-025A	H100-025B
	3/8"	H100-038A	H100-038B
	1/2"	H100-050A	H100-050B
1-1/4" 3/8" Material Hole Diameter	1/4"	H125-025A	H125-025B
	3/8"	H125-038A	H125-038B
	1/2"	H125-050A	H125-050B
1-1/2" 3/8" material Hole Diameter	1/4"	H150-025A	H150-025B
	3/8"	H150-038A	H150-038B
	1/2"	H150-050A	H150-050B









## Hardware for Customizable Standoffs

### Set Screw Studs 304 Stainless Steel Grade

Studs are used to join the cap and barrel. Because this is a custom setup, you will need to determine the length that is required.



















Technical Information	Thread Size	Hole Diameter	Allen Key Size	Length	SKU
 <p>For Caps &amp; Barrels 1/4" Diameter. Add 3/8" to material thickness to pick correct stud</p>	#6-32	1/8"	1/16"	1/4"	SC6/32-01
				3/8"	SC6/32-02
				1/2"	SC6/32-03
				5/8"	SC6/32-06
				3/4"	SC6/32-04
				1"	SC6/32-05
 <p>For Caps &amp; Barrels 3/8", 1/2", 3/4", 1", #10-24 thread Diameter. Add 3/8" to material thickness to pick correct stud</p>	#10-24	7/32"	3/32"	1/4"	SC10/24-02
				3/8"	SC10/24-03
				1/2"	SC10/24-04
				5/8"	SC10/24-05
				3/4"	SC10/24-09
				7/8"	SC10/24-12
				1"	SC10/24-06
				1-1/4"	SC10/24-10
1-1/2"	SC10/24-07				
 <p>Add 3/8" to material thickness to pick correct stud</p>	1/4-20	5/16"	1/8"	5/16"	SC1/420-03
				3/8"	SC1/420-04
				1/2"	SC1/420-05
				5/8"	SC1/420-06
				3/4"	SC1/420-07
				1"	SC1/420-08
				1-1/4"	SC1/420-09
				1-1/2"	SC1/420-10
				2"	SC1/420-11
				 <p>Add 1/2" to material thickness to pick correct stud</p>	5/16-18
1/4"	SC5/16-02				
3/8"	SC5/16-03				
1/2"	SC5/16-04				
5/8"	SC5/16-05				
3/4"	SC5/16-06				
7/8"	SC5/16-07				
1"	SC5/16-08				
1-1/8"	SC5/16-09				
1-1/4"	SC5/16-10				
1-1/2"	SC5/16-11				
1-3/4"	SC5/16-12				
2"	SC5/16-13				
3"	SC5/16-30				
4"	SC5/16-40				

Tempered glass is most vulnerable on its edges and may break from contact with the metal standoff. We recommend using washers and plastic tubing with glass materials. Washers protect the glass from the metal standoff preventing breakage.

### Plastic Tubing



























Technical Information	Inside Diameter	Outside Diameter	Length	SKU
 <p>For 1/4-20 Stud</p>	1/4"	3/8"	1/4"	PT025250
			3/8"	PT025375
			1/2"	PT025500
			3/4"	PT025750
<p>For 5/16-18 Stud</p>	5/16"	7/16"	1/4"	PT250
			3/8"	PT375
			1/2"	PT500
			3/4"	PT750

## Hardware for Customizable Standoffs

Technical Information	Description	For	Diameter	Length	SKU			
	Zinc Combination Screw	Anchor: ANC1, ANC5, ANC5Z	#6-32	1"	HB632			
			#6-32	3/4"	HB632-075Z			
			#6-32	1-1/2"	HB632-150Z			
	Bit Driver	Combination Screw	#6-32	N/A	16766			
	Zinc Combination Screw	Anchor: ANC1, ANC5, ANC5Z	#10-24	1"	HB1024			
			#10-24	1-1/2"	HB1024-12			
			#10-24	2"	HB1024-2			
				Anchor with Combination Screw	Anchor Included	#10-24	N/A	ANC5Z1024S
				Bit Driver	Combination Screw	#10-24	N/A	400.424
	Stainless Steel	ANC1, ANC5, AN CZ, ANC5Z	1/4-20	1"	HB1/4-100			
			Zinc	ANC1, ANC5, AN CZ, ANC5Z	1/4-20	1"	HB1/4-100Z	
			Zinc	Anchor: ANC4	1/4-20	1-1/2"	HB1/4-150	
			Zinc Combination Screw	N/A	1/4-20	2"	HB1/4-200	
	Bit Driver	Combination Screw	1/4-20	N/A	16769			
	Stainless Steel Combination Screw	Anchor: ANC1, ANC5, ANC5Z	5/16-18 to #6	1"	HB5/16-100			
			Zinc Combination Screw	Anchor: ANC1, ANC5, ANC5Z	5/16-18 to #6	1"	HB5/16-100Z	
	Zinc Anchor with Combination Screw HB5/16-100	Anchor Included	5/16-18	1-1/4"	ANC5ZS			
	Hex Head Insert Bit 1/8"	Combination Screw	N/A	N/A	HEXBIT1/8			
	Stainless Steel Combination Screw	Anchor: ANC2, ANC6, ANC6Z	5/16-18 to #8	1-1/4"	HB5/16-125			
			Zinc Combination Screw	Anchor: ANC2, ANC6, ANC6Z	5/16-18 to #8	1-1/4"	HB5/16-125Z	
	Zinc Anchor with Combination Screw HB5/16-125	Anchor Included	5/16-18	N/A	ANC6ZS			
	Hex Head Insert Bit 5/32"	Combination Screw	N/A	N/A	HEXBIT5/32			
	Stainless Steel Combination Screw	Anchor : TBW8	5/16-18	2"	HB5/16-200			
	Toggle Bolt Wings	2300Z or HB5/16-200	8-32	N/A	TBW8			
	Small Nylon Speed Anchor	N/A	#6	1-1/4"	SA5P			
	Large Nylon Speed Anchor	N/A	#8	1-5/8"	LA6P			
	Zinc Speed Anchor	N/A	#6	1"	LA6Z			
	Small Zinc Speed Anchor	N/A	#8	1-1/2"	SA6Z			

## Hardware for Customizable Standoffs

For Drywall and Concrete

Technical Information	Description	For	Diameter	Length	SKU
 	Plastic Anchor for Concrete Drill Size 1/4"	Screw: #6	#6	1-1/8"	LANC1
 	Plastic Anchor for Concrete Drill Size 1/4"	Screw: #6	#6	1-1/8"	ANC1
 	Plastic Anchor for Concrete Drill Size 1/4"	Screw: #8	#8	1-1/8"	ANC2
 	Plastic Anchor for Drywall	Screw: #6	#6	N/A	ANC5
	Zinc Anchor for Drywall	Screw: #6	#6	N/A	ANC5Z
 	Plastic Anchor for Drywall	Screw: #8	#8	N/A	ANC6
	Zinc Anchor for Drywall	Screw: #8	#8	N/A	ANC6Z
	Nylon Toggle Wings	Screw: #8	Pre-Drill 9/16"	N/A	TBW9
	Nylon Toggle Tool	Anchor: TBW9	N/A	N/A	TBW9K
	Zinc Steel Combination Screw For Toggle Wing #6	Anchor: TBW6	1/4-20 to 6-32	2"	HB025-200
	Spring Toggle Wings	Screw: HB025-200	Pre-Drill 3/8"	N/A	TBW6
	Combination Screw For Toggle Wing #6	Anchor: TBW8	5/16-18 to 8-32	2"	HB5/16-200
	Spring Toggle Wings	Screw: HB5/16-200	Pre-Drill 9/16"	N/A	TBW8
	Zinc Hanger Bolt	None	5/16-18 to #12	1-1/2"	HB5/16-150
	Zinc Hanger Bolt	None	#8	1-1/4"	HB5/16-150Z
	Zinc Hanger Bolt	None	5/16 to #12	2"	HB5/16-2
	Zinc Hanger Bolt	None	5/16 to #12	4"	HB5/16-4
	Stainless Steel M4 Combination Screw	N/A	M4	N/A	400.700
	5/16 Thread Insert Sold without Screw	N/A	5/16"	1/4"	Insert516
	Screw for Insert 5/16	Anchor: TBW6	6/32"	2-1/2"	2200Z
	Hex Head Insert Bit	N/A	1/8"	2"	HEXBIT1/8
	Hex Head Insert Bit	N/A	5/32"	2"	HEXBIT5/32

## Machine Screws, Flat / Pan Head

Machine screws Zinc plated



Description	Thread	Length	Flat #	Pan #		
#6-32 Machine Screws, Phillips, Zinc Plated Steel	#6-32	3/16"	9325	N/A		
		1/4"	7601	N/A		
		5/16"	9326	N/A		
		3/8"	1487	N/A		
		7/16"	9327	N/A		
		1/2"	1488	1542		
		5/8"	1489	1543		
		3/4"	1490	1544		
		7/8"	9328	9228		
		1"	1491	1545		
		1-1/4"	1492	1546		
		1-1/2"	1493	1547		
		2"	1494	1548		
		#10-24 Machine Screws, Phillips, Zinc Plated Steel	#10-24	5/16"	9545	9242
1/4"	N/A			9241		
3/8"	1507			1561		
1/2"	1508			1562		
5/8"	1509			1563		
3/4"	1510			1564		
7/8"	9546			N/A		
1"	1511			1565		
1-1/4"	1512			1566		
1-1/2"	1513			1567		
1-3/4"	9547			N/A		
2"	1514			1568		
1/4-20 Machine Screws, Phillips, Zinc Plated Steel	1/4-20			3/8"	1529	N/A
				1/2"	1530	1584
		5/8"	1531	N/A		
		3/4"	1532	1586		
		7/8"	9573	N/A		
		1"	1533	1587		
		1-1/4"	1534	N/A		
		1-1/2"	1535	N/A		
		1-3/4"	9574	N/A		
		2"	1536	N/A		
		5/16-18 Machine Screws, Phillips, Zinc Plated Steel	5/16-18	1/2"	9580	N/A
				3/4"	9581	9284
				7/8"	N/A	9285
				1"	N/A	9286
1-1/4"	9583			9287		
1-1/2"	9584			9288		
1-3/4"	9585			N/A		
2"	9586	N/A				



### Tools for Customizable Standoffs

Technical Information	Description	For	SKU
	68 Piece Tool Set	N/A	SETBIT
	Screw Driver for Hex 1/4" Bit with Ergonomic Rubber Handle	N/A	61300
	Mini Stubby Handle for Hex 1/4" Bit	N/A	61200
	1/4" Magnetic Bit Holder	N/A	MBH1/4
	Allen Wrench	N/A	ALLENM4
	1.5 Millimeter Allen Wrench, Short Arm	N/A	ALLENM15
	2.0 Millimeter Allen Wrench, Short Arm	N/A	ALLENM2
	1/8" Allen Wrench, Short Arm	N/A	ALLENK1/8
	3/16" Allen Wrench, Short Arm	N/A	ALLENK3/16
	3/32" Allen Wrench, Short Arm	N/A	ALLENK3/32
	5/32" Allen Wrench, Short Arm	N/A	ALLENK5/32
	7/32" Allen Wrench, Short Arm	N/A	ALLENK7/32
	1.5 Millimeter Allen Wrench, Ball End, Long Arm	N/A	ALLENM15L
	2.5 Millimeter Allen Wrench, Short Arm, Long Arm	N/A	ALLENM25
	2.5 Millimeter Allen Wrench, Ball End, Long Arm	N/A	ALLENM25L
	2.0 Millimeter Allen Wrench, Ball End, Long Arm	N/A	ALLENM2L
	3.0 Millimeter Allen Wrench, Short Arm	N/A	ALLENM3
	4.0 Millimeter Allen Wrench, Short Arm	N/A	ALLENM4
	4.0 Millimeter Allen Wrench, Ball End, Long Arm	N/A	ALLENM4L
	5.0 Millimeter Allen Wrench, Short Arm	N/A	ALLENM5
	Bit Driver 6-32	HB632 Screws	16766
	Bit Driver 10-24	HB1024, HB1024-2, HB1024-12	400.424
	Bit Driver 1/4-20	HB1/4-100(Z) & HB1/4-150(Z)	16769
	Hex Head Insert Bit 1/8"	HB5/16-100(Z)	HEXBIT1/8
	Hex Head Insert Bit 5/32"	HB5/16-125(Z)	HEXBIT5/32
	Steel Hex Drill Bit 5/32"	N/A	HDB532
	Steel Hex Drill Bit 1/4"	N/A	HDB14
	Cobalt Drill Bit 3"	N/A	DB732
	Locking Cap Tool	For Aluminum and Stainless Steel Locking Caps	LS01



SKU: 61200









SKU: 61300



SKU: SETBIT

### Tools for Customizable Standoffs

Technical Information	Description	For	SKU
	Bit Driver 6-32	HB632 Screws	16766
	Bit Driver 10-24	HB1024, HB1024-2, HB1024-12	400.424
	Bit Driver 1/4-20	HB1/4-100(Z) & HB1/4-150(Z)	16769
	Hex Head Insert Bit 1/8"	HB5/16-100(Z)	HEXBIT1/8
	Hex Head Insert Bit 5/32"	HB5/16-125(Z)	HEXBIT5/32
	Steel Hex Drill Bit 5/32"	N/A	HDB532
	Steel Hex Drill Bit 1/4"	N/A	HDB14
	Cobalt Drill Bit 3"	N/A	DB732
	Locking Cap Tool	For Aluminum and Stainless Steel Locking Caps	LS01



SKU: 61200





SKU: 61300



SKU: SETBIT



## Screw Cap Covers

<b>NEW</b> Products Added		Aluminum Screw Cap Covers	106
<b>NEW</b> Products Added		Stainless Steel & Brass Screw Cap Covers	107
<b>NEW</b> Products Added		Tapcon Screw Cap Covers	108
		Snap Caps for Screw	109
		Stemfix, Bifix Caps and Washers	110
		Aluminum Panel Clip	111
		Stainless Steel Tamper Proof Screws	112



## Aluminum Screw Cap Covers

Set of 4 Screw Covers – For Indoor and Outdoor Use

### Flat Head

Diameter	Cap Height								
		Aluminum Clear (A)	Aluminum Shiny (AS)	Aluminum Black (B)	Aluminum Matte Black (MB) <b>NEW</b>	Aluminum Gold (G)	Aluminum Champagne (BR) <b>NEW</b>	Aluminum Bronze (AB)	Aluminum Titanium (T)
1/2"	1/4"	SC12A	SC12AS	SC12B	SC12MB	SC12G	SC12BR	SC12AB	SC12T
5/8"		SC16A	SC16AS	SC16B	SC16MB	SC16G	SC16BR	SC16AB	SC16T
11/16"		SC18A	SC18AS	SC18B	SC18MB	SC18G	SC18BR	SC18AB	SC18T
13/16"		SC20A	SC20AS	SC20B	SC20MB	SC20G	SC20BR	SC20AB	SC20T
7/8"		SC22A	SC22AS	SC22B	SC22MB	SC22G	SC22BR	SC22AB	SC22T
1"		SC25A	SC25AS	SC25B	SC25MB	SC25G	SC25BR	SC25AB	SC25T

### Flat Head Tamper Proof

Requires M3 allen key

Diameter	Cap Height							
		Aluminum Clear (A) <b>NEW</b>	Aluminum Shiny (AS) <b>NEW</b>	Aluminum Black (B) <b>NEW</b>	Aluminum Gold (G) <b>NEW</b>	Aluminum Champagne (BR) <b>NEW</b>	Aluminum Bronze (AB) <b>NEW</b>	Aluminum Titanium (T) <b>NEW</b>
5/8"	1/4"	SC16LA	SC16LAS	SC16LB	SC16LG	SC16LBR	SC16LAB	SC16LT
11/16"		SC18LA	SC18LAS	SC18LB	SC18LG	SC18LBR	SC18LAB	SC18LT
13/16"		SC20LA	SC20LAS	SC20LB	SC20LG	SC20LBR	SC20LAB	SC20LT
7/8"		SC22LA	SC22LAS	SC22LB	SC22LG	SC22LBR	SC22LAB	SC22LT
1"		SC25LA	SC25LAS	SC25LB	SC25LG	SC25LBR	SC25LAB	SC25LT

### Conical

Diameter	Cap Height							
		Aluminum Clear (A) <b>NEW</b>	Aluminum Shiny (AS) <b>NEW</b>	Aluminum Black (B) <b>NEW</b>	Aluminum Gold (G) <b>NEW</b>	Aluminum Champagne (BR) <b>NEW</b>	Aluminum Bronze (AB) <b>NEW</b>	Aluminum Titanium (T) <b>NEW</b>
1/2"	1/4"	SC12CA	SC12CAS	SC12CB	SC12CG	SC12CBR	SC12CAB	SC12CT
5/8"		SC16CA	SC16CAS	SC16CB	SC16CG	SC16CBR	SC16CAB	SC16CT
11/16"		SC18CA	SC18CAS	SC18CB	SC18CG	SC18CBR	SC18CAB	SC18CT
13/16"		SC20CA	SC20CAS	SC20CB	SC20CG	SC20CBR	SC20CAB	SC20CT
7/8"		SC22CA	SC22CAS	SC22CB	SC22CG	SC22CBR	SC22CAB	SC22CT
1"		SC25CA	SC25CAS	SC25CB	SC25CG	SC25CBR	SC25CAB	SC25CT

### Conical Tamper Proof

Requires M3 allen key

Diameter	Cap Height							
		Aluminum Clear (A) <b>NEW</b>	Aluminum Shiny (AS) <b>NEW</b>	Aluminum Black (B) <b>NEW</b>	Aluminum Gold (G) <b>NEW</b>	Aluminum Champagne (BR) <b>NEW</b>	Aluminum Bronze (AB) <b>NEW</b>	Aluminum Titanium (T) <b>NEW</b>
5/8"	1/4"	SC16CLA	SC16CLAS	SC16CLB	SC16CLG	SC16CLBR	SC16CLAB	SC16CLT
11/16"		SC18CLA	SC18CLAS	SC18CLB	SC18CLG	SC18CLBR	SC18CLAB	SC18CLT
13/16"		SC20CLA	SC20CLAS	SC20CLB	SC20CLG	SC20CLBR	SC20CLAB	SC20CLT
7/8"		SC22CLA	SC22CLAS	SC22CLB	SC22CLG	SC22CLBR	SC22CLAB	SC22CLT
1"		SC25CLA	SC25CLAS	SC25CLB	SC25CLG	SC25CLBR	SC25CLAB	SC25CLT

## Stainless Steel & Brass Screw Cap Covers

Set of 4 Screw Covers – For Indoor and Outdoor Use

### Flat Head

Diameter	Cap Height					
		Stainless Steel Satin Brushed (201) (SS)	Stainless Steel Polished (201) (SP)	Stainless Steel Satin Brushed (304) (SS)	Stainless Steel Polished (304) (SP)	Brass (BRA) <b>NEW</b>
1/2"	1/4"	SC12SSS	SC12SSP	SC12SS304	SC12SSP304	SC12BRA
5/8"		SC16SSS	SC16SSP	SC16SS304	SC16SSP304	SC16BRA
11/16"		SC18SSS	SC18SSP	SC18SS304	SC18SSP304	SC18BRA
13/16"		SC20SSS	SC20SSP	SC20SS304	SC20SSP304	SC20BRA
7/8"		SC22SSS	SC22SSP	SC22SS304	SC22SSP304	SC22BRA
1"		SC25SSS	SC25SSP	SC25SS304	SC25SSP304	SC25BRA

### Flat Head Tamper Proof

Requires M3 allen key

Diameter	Cap Height					
		Stainless Steel Satin Brushed (201) (SS) <b>NEW</b>	Stainless Steel Polished (201) (SP) <b>NEW</b>	Stainless Steel Satin Brushed (304) (SS) <b>NEW</b>	Stainless Steel Polished (304) (SP) <b>NEW</b>	Brass (BRA) <b>NEW</b>
5/8"	1/4"	SC16LSSS	SC16LSSP	SC16LSS304	SC16LSSP304	SC16LBRA
11/16"		SC18LSSS	SC18LSSP	SC18LSS304	SC18LSSP304	SC18LBRA
13/16"		SC20LSSS	SC20LSSP	SC20LSS304	SC20LSSP304	SC20LBRA
7/8"		SC22LSSS	SC22LSSP	SC22LSS304	SC22LSSP304	SC22LBRA
1"		SC25LSSS	SC25LSSP	SC25LSS304	SC25LSSP304	SC25LBRA

### Conical

Diameter	Cap Height					
		Stainless Steel Satin Brushed (201) (SS) <b>NEW</b>	Stainless Steel Polished (201) (SP) <b>NEW</b>	Stainless Steel Satin Brushed (304) (SS) <b>NEW</b>	Stainless Steel Polished (304) (SP) <b>NEW</b>	Brass (BRA) <b>NEW</b>
1/2"	1/4"	SC12CSSS	SC12CSSP	SC12CSS304	SC12CSSP304	SC12CBRA
5/8"		SC16CSSS	SC16CSSP	SC16CSS304	SC16CSSP304	SC16CBRA
11/16"		SC18CSSS	SC18CSSP	SC18CSS304	SC18CSSP304	SC18CBRA
13/16"		SC20CSSS	SC20CSSP	SC20CSS304	SC20CSSP304	SC20CBRA
7/8"		SC22CSSS	SC22CSSP	SC22CSS304	SC22CSSP304	SC22CBRA
1"		SC25CSSS	SC25CSSP	SC25CSS304	SC25CSSP304	SC25CBRA

### Conical Tamper Proof

Requires M3 allen key

Diameter	Cap Height					
		Stainless Steel Satin Brushed (201) (SS) <b>NEW</b>	Stainless Steel Polished (201) (SP) <b>NEW</b>	Stainless Steel Satin Brushed (304) (SS) <b>NEW</b>	Stainless Steel Polished (304) (SP) <b>NEW</b>	Brass (BRA) <b>NEW</b>
5/8"	1/4"	SC16CLSSS	SC16CLSSP	SC16CLSS304	SC16CLSSP304	SC16CLBRA
11/16"		SC18CLSSS	SC18CLSSP	SC18CLSS304	SC18CLSSP304	SC18CLBRA
13/16"		SC20CLSSS	SC20CLSSP	SC20CLSS304	SC20CLSSP304	SC20CLBRA
7/8"		SC22CLSSS	SC22CLSSP	SC22CLSS304	SC22CLSSP304	SC22CLBRA
1"		SC25CLSSS	SC25CLSSP	SC25CLSS304	SC25CLSSP304	SC25CLBRA

## Tapcon Screw Cap Covers

- Product** | Screw Covers
- Unique Features** | Indoor & Outdoor  
Set of 4 Screws  
9 Different Finishes  
2 Different Materials
- Area Of Use** | Designed for flush mounted projects on concrete.  
Blocks  
Bricks
- Additional Details** | Tapcon Screws are corrosion resistant sold separately.



### Flat Head Aluminum

Diameter	Cap Height	NEW						
		Aluminum Clear (A)	Aluminum Shiny (AS)	Aluminum Black (B)	Aluminum Gold (G)	Aluminum Champagne (BR)	Aluminum Bronze (AB)	Aluminum Titanium (T)
5/8"	1/4"	SC058T316A	SC058T316AS	SC058T316B	SC058T316G	SC058T316BR	SC058T316AB	SC058T316T
3/4"		SC075T316A	SC075T316AS	SC075T316B	SC075T316G	SC075T316BR	SC075T316AB	SC075T316T
1"		SC100T316A	SC100T316AS	SC100T316B	SC100T316G	SC100T316BR	SC100T316AB	SC100T316T

### Flat Head Stainless Steel

Diameter	Cap Height	NEW			
		Stainless Steel Satin Brushed 304 (SS)	Stainless Steel Polished 304 (SP)	Stainless Steel Satin Brushed 316 (SS)	Stainless Steel Polished 316 (SP)
5/8"	1/4"	SC058T316SS304	SC058T316SSP304	SC058T316SS316	SC058T316SSP316
3/4"		SC075T316SS304	SC075T316SSP304	SC075T316SS316	SC075T316SSP316
1"		SC100T316SS304	SC100T316SSP304	SC100T316SS316	SC100T316SSP316

### Concrete Screws

<b>NEW</b>	<b>NEW</b>	<b>NEW</b>
3/16" x 1-1/4"	3/16" x 1-3/4"	3/16" x 2-1/4"
SKU: 10816	SKU: 10817	SKU: 10818



## Stainless Steel Tamper Proof Screws

For Indoor and Outdoor use

Description	Drive	Length	SKU
 #8 Sheet Metal Screws Torx – Flat Head Stainless Steel 18-8	T20	1/2"	91800
	T20	5/8"	91805
	T20	3/4"	91810
	T20	1"	91820
	T20	1-1/4"	91830
 #10-24 Machine Screw Torx – Flat Head Stainless Steel 18-8	T20	1-1/2"	91840
	T20	3/8"	91600
	T20	1/2"	91605
	T20	5/8"	91608
	T20	3/4"	91610
	T20	1"	91615
	T20	1-1/4"	91620
	T20	1-1/2"	91625

## Stainless Steel Tamper Proof Washer and Torx Screw

For Indoor and Outdoor use

### 18-8 stainless steel Set of 4

5/8" Diameter washer with #8 Sheet Metal screws – torx – flat head

Diameter	Material Thickness Accepted	Driver	SKU
5/8"	up to 1/2"	T20	WSC-1
Torx Bit Driver		T20	101020

Drywall Hardware: anchor ANC6, ANC6Z  
Concrete Hardware: anchor ANC2





## Screw Cover Caps

Cover Up Exposed Fixings with Screw Caps



### Snap-Caps

Snap-Caps are the best and most secure way to cover and protect screws, fixings and fasteners. Available in a variety of colors for that custom look.



### Stemfix Caps

Stemfix (aka "Pin Caps") are low-profile plastic caps, which achieve a secure grip when used in special "drilled-hole" screws, such as "SupaChip" or Confirmat screws. Stemfix have a positive grip that is easy to fit, but not-so easy to remove.



### Bifix Caps

Low-profile Press-in caps for "Pozi" & "Phillips" screws, Bifix Caps are the ultimate "Pozi" caps, that press into the drive recess of countersunk screws. Bifix Caps fit Pozi and Phillips head screws that have a No.2 drive recess.

### Snap Cap Washers

Washers	For Cap	For Screw	SKU
For Counter Sink Screw	All SC6/8	2208, 2216	W6/8CS
	All SC10/12	2225, 2234	W10/12CS
For Flat Head Screw	All SC6/8	PT6075, PT6150, PT8075, PT8150	W6/8FB
	All SC10/12		W10/12FB

### Screws

Screw	Material	Length	For Screw	SKU
Flat Countersunk Head Screw	Stainless Steel	3/4"	#6	2206
	Zinc Plated	1"	#6	2431
	Stainless Steel	1-1/2"	#6	2208
	Stainless Steel	2"	#6	2209
	Stainless Steel	3/4"	#8	2214
	Stainless Steel	1-1/2"	#8	2216
	Stainless Steel	2"	#8	2217
	Stainless Steel	1-1/4"	#12	2234
	Zinc Plated	1"	#8	2438
	Flat Countersunk Head Screw Made for Steamfix Caps	Galvanized	1-1/8"	#9



### Electroplated Snap-Caps

High-quality finish on polished metal, mirrors, glass, and other high-gloss surfaces. The finish is tough and durable, and is resistant to most household cleaning products.

Diameter	Finish	Fit Screw Sizes	SKU
1/2"	White	#6, #8, M3, M4	BFXWH
1/2"	Black		BFBK

Diameter	Finish	Fit Screw Sizes	SKU
1/2"	White	#6, #8, M3, M4	STFWH
1/2"	Black		STFBK

## Snap Caps for Screw

For Indoor and Outdoor Use



Diameter	Finish	Fit Screw Sizes	SKU
1/2"	Black Gloss	#6, #8, M3, M4	SC6/8BG
5/8"		#10, #12, #14, M5, M6	SC10/12BG
1/2"	Blaze Gloss	#6, #8, M3, M4	SC6/8BLG
5/8"		#10, #12, #14, M5, M6	SC10/12BLG
1/2"	Caspian Blue Gloss	#6, #8, M3, M4	SC6/8CBG
5/8"		#10, #12, #14, M5, M6	SC10/12CBG
1/2"	Charcoal Gloss	#6, #8, M3, M4	SC6/8CG
5/8"		#10, #12, #14, M5, M6	SC10/12CG
1/2"	Fern Green Gloss	#6, #8, M3, M4	SC6/8FEG
5/8"		#10, #12, #14, M5, M6	SC10/12FEG
1/2"	Forest Green Gloss	#6, #8, M3, M4	SC6/8FGG
5/8"		#10, #12, #14, M5, M6	SC10/12FGG
1/2"	Fog Grey Gloss	#6, #8, M3, M4	SC6/8FOG
5/8"		#10, #12, #14, M5, M6	SC10/12FOG
1/2"	Heritage Green Gloss	#6, #8, M3, M4	SC6/8HGG
5/8"		#10, #12, #14, M5, M6	SC10/12HGG
1/2"	Mandarin Gloss	#6, #8, M3, M4	SC6/8MG
5/8"		#10, #12, #14, M5, M6	SC10/12MG
1/2"	Medium Slate Gloss	#6, #8, M3, M4	SC6/8MSG
5/8"		#10, #12, #14, M5, M6	SC10/12MSG
1/2"	Light Grey Gloss	#6, #8, M3, M4	SC6/8LGG
5/8"		#10, #12, #14, M5, M6	SC10/12LGG
1/2"	Red Gloss	#6, #8, M3, M4	SC6/8RG
5/8"		#10, #12, #14, M5, M6	SC10/12RG
1/2"	Royal Blue Gloss	#6, #8, M3, M4	SC6/8RBG
5/8"		#10, #12, #14, M5, M6	SC10/12RBG
1/2"	Sea Blue Gloss	#6, #8, M3, M4	SC6/8SBG
5/8"		#10, #12, #14, M5, M6	SC10/12SBG
1/2"	Space Blue Gloss	#6, #8, M3, M4	SC6/8SPG
5/8"		#10, #12, #14, M5, M6	SC10/12SPG
1/2"	Silver Grey Gloss	#6, #8, M3, M4	SC6/8SGG
5/8"		#10, #12, #14, M5, M6	SC10/12SGG
1/2"	White Gloss	#6, #8, M3, M4	SC6/8WG
5/8"		#10, #12, #14, M5, M6	SC10/12WG
1/2"	Yellow Gloss	#6, #8, M3, M4	SC6/8YG
5/8"		#10, #12, #14, M5, M6	SC10/12YG
1/2"	Electroplated Polished Chrome	#6, #8, M3, M4	SC6/8EPC
5/8"		#10, #12, #14, M5, M6	SC10/12EPC
1/2"	Electroplated Satin Chrome	#6, #8, M3, M4	SC6/8ESC
5/8"		#10, #12, #14, M5, M6	SC10/12ESC
1/2"	Electroplated Gold	#6, #8, M3, M4	SC6/8EPG
5/8"		#10, #12, #14, M5, M6	SC10/12EPG

## Aluminum Panel Clip

**Product** Panel Clip  
Disc  
Vinyl Shims  
Screw and Anchor

**Unique Features** Indoor & Outdoor Use

**Area Of Use** Signage  
Wayfinder  
Display  
Advertising

**Additional Details** Designed for flat material signs



### Instructions

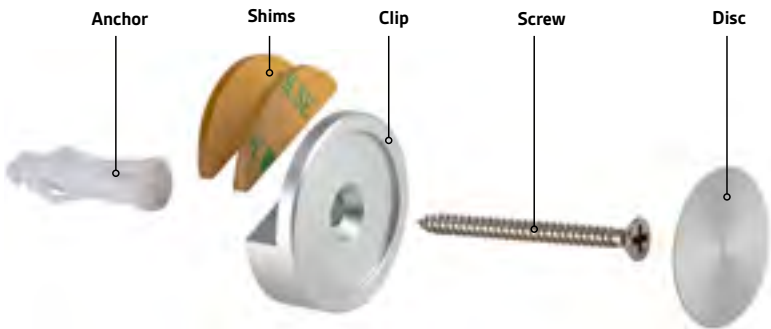

1. Mark the wall 3/16" above and below your desired location of the panel edges.
2. Pre-drill 1/4" holes in your surface, then insert nylon anchors into the holes and tap them flush.
3. Drive oval head screws into anchor to mount lower clips. Slide in panel and install upper clips.
4. Remove the adhesive backing from discs and place one into the recess on the face of each clip.

## Aluminum Panel Clip

### Panel Mounting Kit

- 4 x Discs
- 4 x Barrels
- 8 x Shims
- 4 x Screws
- 4 x Anchors



Diameter	Distance From Wall	Material Thickness Accepted	Clear (A)	Shiny (AS)	Matte Black (MB)	Champagne (BR)
5/8"	3/8"	1/8", 3/16", 1/4"	APC-058A	APC-058AS	APC-058MB	APC-058BR
3/4"			APC-075A	APC-075AS	APC-075MB	APC-075BR
1"			APC-100A	APC-100AS	APC-100MB	APC-100BR
1-1/4"			APC-125A	APC-125AS	APC-125MB	APC-125BR

Diameter: Drywall Hardware: screw 2208 anchor ANC5, ANC5Z. Concrete Hardware: anchor 2208

### Spare Discs

Set of 4 Discs with 3M Adhesive



For Diameter	Clear (A)	Shiny (AS)	Matte Black (MB)	Champagne (BR)
5/8"	DISC058A	DISC058AS	DISC058MB	DISC058BR
3/4"	DISC075A	DISC075AS	DISC075MB	DISC075BR
1"	DISC100A	DISC100AS	DISC100MB	DISC100BR
1-1/4"	DISC125A	DISC125AS	DISC125MB	DISC125BR

### Spare Shims

Set of 4 Shims with 3M Adhesive



For Diameter	Shim
5/8"	VS058
3/4"	VS075
1"	VS100
1-1/4"	VS125





## Panel Mount Systems

	Aluminum Z-Clip Panel Mounts	116		Button-Fix	132		
<b>NEW</b> Products Added		Aluminum Z-Clip Panel Mounts Kits	120	<b>NEW</b> Products Added		Button-Fix with Tools	136
<b>NEW</b> Products Added		Acrylic French Cleat Kits	122	<b>NEW</b> Products Added		Spacers	138
		Stainless Steel Flush Hangers	124				
		Quick Snap Standoffs	126				
		Quick Snap Adhesives	129				
		Quick Snap Expander Standoffs	130				
		Letter Mounting Studs	131				



## Z-Clip Panel Mounts

<b>Product</b>	Panel Mount
<b>Unique Features</b>	Aluminum Indoor Use Only Long lasting Easy to install Versatile Invisible
<b>Area Of Use</b>	Mirrors Panels Artwork Cabinet
<b>Additional Details</b>	5/16" Projection, 5/8" Lift-Off All Pre-drilled for Easy Installation



### Quick and Easy to Install

With the help of few simple tools, you can quickly and easily install our reliable Z-Clips.

The Z-CLIP system is a fast, easy, and a cost effective method to lock in place any kind of wall panel, including acoustical panels, partitions, cabinets, signage, artwork, etc. The "Z" shaped clips wedge together locking panels in place which allows 50% cut in cost and installation time. The Z-CLIP system provides ample access to easy mounting and removal of panels for any changes or replacements.

Z-Clips are discreet and allow for a pre-finished look without the time consuming face nailing and costly on-the-job finishing.



Long Lasting



Easy to Install



Versatile



Invisible

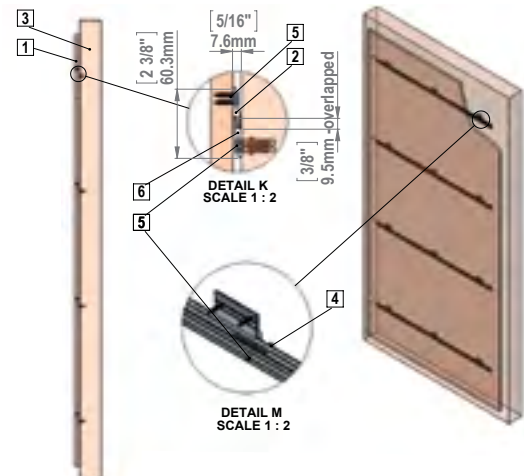
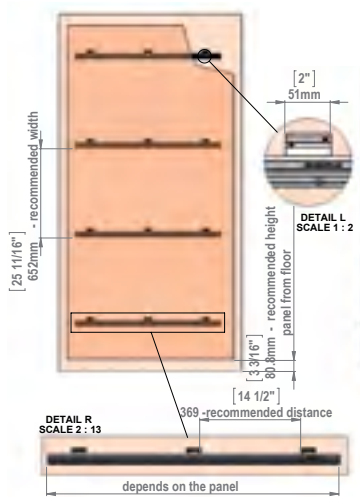

## Z-Clip Panel Mounts



### ZCP1 - Medium to Heavy Duty Applications

Wood and metal panels, large picture frames, wall decorations, shelves.

### ZCP2 - Light to Medium Duty Applications

Picture frames, wall decorations, signs, shelves.

### ZCP3 - Medium to Heavy Duty Applications

Cabinets, wood and metal panels, large picture frames, wall decorations, shelves.



NEW

### Z-Clip Panel Mount Kits



Page 120

NEW

### Acrylic Z-Clip Panel Mounts



Page 122



## Z-Clip Panel Mounts

### ZCP1 - Medium to Heavy Duty Applications



Width	SKU
2"	ZCP1
36"	ZCP1-3
72"	ZCP1-6
Lift 3/8"	

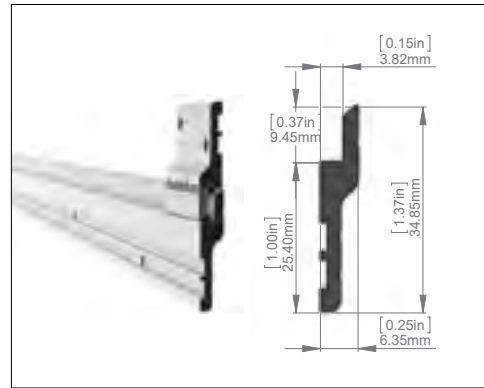

## Z-Clip Panel Mounts

### ZCP3 - Medium to Heavy Duty Applications



Width	SKU
2-1/2"	ZCP3
36"	ZCP3-3
72"	ZCP3-6
Lift 1/2"	

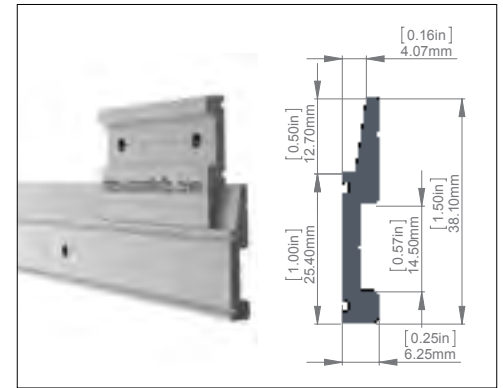

### ZCP2 - Light to Medium Duty Applications

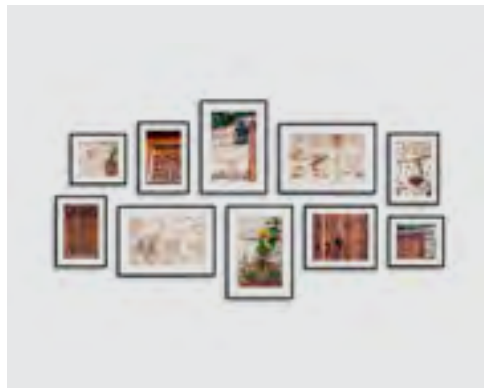

Width	SKU
1-1/2"	ZCP2
36"	ZCP2-3
72"	ZCP2-6
Lift 5/8"	

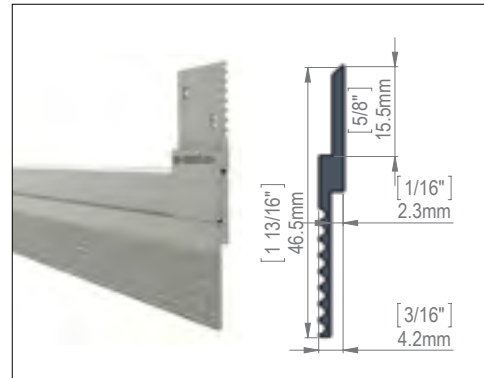

### Z-Clip Sample Box With Instruction Guide



Description	SKU
ZCP Sample Box with 2 Pieces of ZCP1, ZCP2, ZCP3; Instruction Guide and Description	ZCPSAMPLEBOX



## Z-Clip Panel Mount Kits

**Product** | Panel Mount Kits

**Unique Features** | Aluminum  
Indoor Use Only  
Sold as a Kit  
Hardware included

**Area Of Use** | Mirrors  
Panels  
Artwork  
Cabinet  
Whiteboard

**Additional Details** | 5/16" Projection,  
5/8" Lift-Off

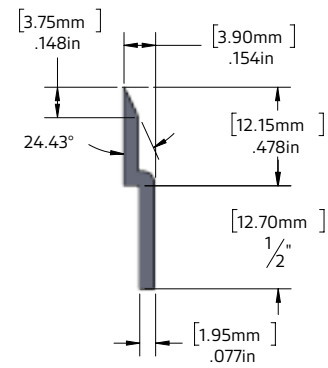

### 2" Aluminum French Cleat Kit

12 x French Cleats (6 pairs)  
12 x 7mm diameter x 24mm screw  
12 x 7mm diameter x 10mm screw  
12 x Anchor for concrete or drywall  
12 x Clear bumpers with adhesive  
1 x Installation guide

SKU: ZCPO-2



### 4" Aluminum French Cleat Kit

10 x French Cleats (5 pairs)  
10 x 7mm diameter x 24mm screw  
10 x 7mm diameter x 10mm screw  
10 x Anchor for concrete or drywall  
10 x Clear bumpers with adhesive  
1 x Installation guide

SKU: ZCPO-4



## Z-Clip Panel Mount Kits

### 6" Aluminum French Cleat Kit

6 x French Cleats (3 pairs)  
12 x 7mm diameter x 24mm screw  
12 x 7mm diameter x 10mm screw  
12 x Anchor for concrete or drywall  
6 x Clear bumpers with adhesive  
1 x Installation guide

SKU: ZCPO-6



### 12" Aluminum French Cleat Kit

4 x French Cleats (2 pairs)  
10 x 7mm diameter x 24mm screw  
10 x 7mm diameter x 10mm screw  
10 x Anchor for concrete or drywall  
4 x Clear bumpers with adhesive  
1 x Installation guide

SKU: ZCPO-12



### 18" Aluminum French Cleat Kit

2 x French Cleats (1 pair)  
8 x 7mm diameter x 24mm screw  
8 x 7mm diameter x 10mm screw  
8 x Anchor for concrete or drywall  
4 x Clear bumpers with adhesive  
1 x Installation guide

SKU: ZCPO-18



### 24" Aluminum French Cleat Kit

2 x French Cleats (1 pair)  
11 x 7mm diameter x 24mm screw  
11 x 7mm diameter x 10mm screw  
11 x Anchor for concrete or drywall  
4 x Clear bumpers with adhesive  
1 x Installation guide

SKU: ZCPO-24



### 30" Aluminum French Cleat Kit

2 x French Cleats (1 pair)  
14 x 7mm diameter x 24mm screw  
14 x 7mm diameter x 10mm screw  
14 x Anchor for concrete or drywall  
4 x Clear bumpers with adhesive  
1 x Installation guide

SKU: ZCPO-30



## Acrylic French Cleat Kits

**Product** Acrylic French Cleats

**Unique Features** Indoor Use Only  
1/2" Thick Acrylic  
Comes with Hardware

**Area Of Use** Acrylics  
Artwork  
Pictures  
Frames

**Additional Details** For items weighing over 100 pounds, we recommend using Butterfly anchors.

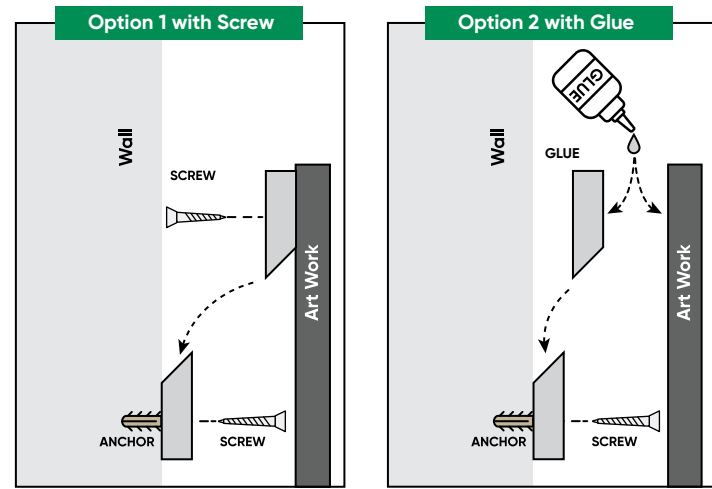
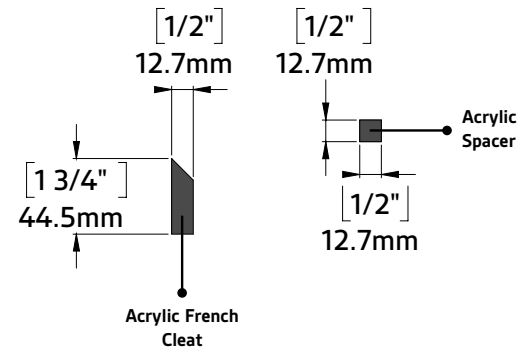
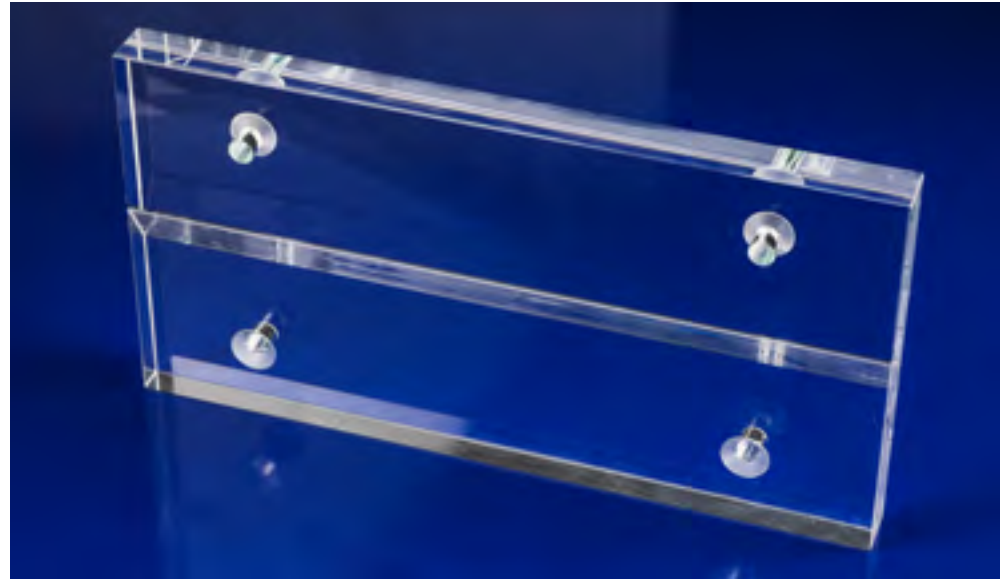

\*Hardware included

\*Does not come with adhesive

### 2" Acrylic French Cleat Kit

2 x Acrylic French Cleats  
2 x Acrylic Spacers  
4 x 4mm diameter x 40mm screw  
4 x Anchor for concrete or drywall  
1 x Installation guide

SKU: AFC2



### 4" Acrylic French Cleat Kit

2 x Acrylic French Cleats  
4 x Acrylic Spacers  
4 x 4mm diameter x 40mm screw  
4 x Anchor for concrete or drywall  
1 x Installation guide

SKU: AFC4



## Acrylic French Cleat Kits

### 6" Acrylic French Cleat Kit

2 x Acrylic French Cleats  
4 x Acrylic Spacers  
4 x 4mm diameter x 40mm screw  
4 x Anchor for concrete or drywall  
1 x Installation guide

SKU: AFC6



### 8" Acrylic French Cleat Kit

2 x Acrylic French Cleats  
4 x Acrylic Spacers  
4 x 4mm diameter x 40mm screw  
4 x Anchor for concrete or drywall  
1 x Installation guide

SKU: AFC8



### 10" Acrylic French Cleat Kit

2 x Acrylic French Cleats  
4 x Acrylic Spacers  
6 x 4mm diameter x 40mm screw  
6 x Anchor for concrete or drywall  
1 x Installation guide

SKU: AFC10



### 12" Acrylic French Cleat Kit

2 x Acrylic French Cleats  
4 x Acrylic Spacers  
8 x 4mm diameter x 40mm screw  
8 x Anchor for concrete or drywall  
1 x Installation guide

SKU: AFC12



### 14" Acrylic French Cleat Kit

2 x Acrylic French Cleats  
4 x Acrylic Spacers  
8 x 4mm diameter x 40mm screw  
8 x Anchor for concrete or drywall  
1 x Installation guide

SKU: AFC14



### 16" Acrylic French Cleat Kit

2 x Acrylic French Cleats  
4 x Acrylic Spacers  
12 x 4mm diameter x 40mm screw  
12 x Anchor for concrete or drywall  
1 x Installation guide

SKU: AFC16





## Flush Hangers

**Product** | Flush Hangers

**Unique Features** | Indoor Use Only  
Easily Removable  
Screw Mounted  
Heavy Duty

**Area Of Use** | Large Picture Frames  
Home Decorations  
Acrylics  
Artworks  
Panels

**Additional Details** | Weight Load:  
66lb / 30kg  
Sold as Pair



## Flush Hangers

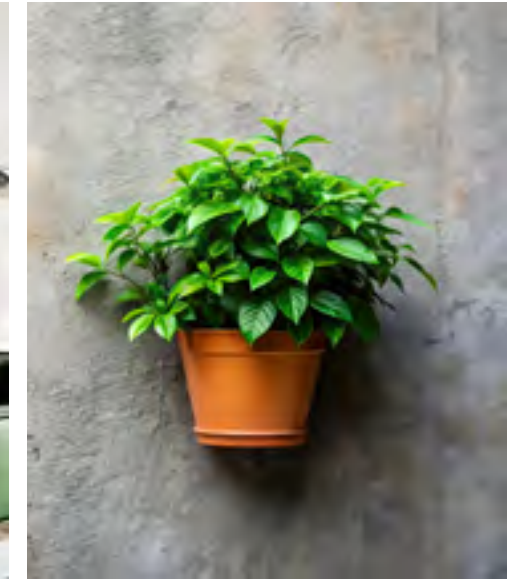

### Small Flush Mount Hanger (2 hole)



### Big Flush Mount Hanger (4 hole)



Material	Length	Thickness	SKU
Steel	1-5/8"	0.17"	FMH1Z

Use for drywall: 2208 and anchor ANC5, ANC5Z  
Use for concrete 2208 and anchor ANC1

Material	Length	Thickness	SKU
Zinc Plated	2-1/16"	0.17"	FMH2Z

Use for drywall: 2208 and anchor ANC5, ANC5Z  
Use for concrete 2208 and anchor ANC1

## Quick Snap Standoffs

- Adhesive or screw mounted options
- 8 different sizes
- 3 different colors

**UV PROOF**



The Quick Snap system is used for the installation of letters in relief. No drilling required and no screws visible on the face of the letters. The system is very simple and quick to use.

### Select the Best item with this Easy to Use Chart

Item	Maximum Height for Letter	Maximum weight per "QS"	Use
Mini	7-7/8"	0.55 lb (250 g)	Indoor & Outdoor
Small	7-7/8"	0.55 lb (250 g)	Indoor & Outdoor
Medium	9-13/16"	0.55 lb (250 g)	Indoor & Outdoor
Large	9-13/16"	0.55 lb (250 g)	Indoor & Outdoor
Big	9-3/16"	0.55 lb (250 g)	Indoor & Outdoor
Extra Big	15-3/4"	0.88 lb (400 g)	Indoor & Outdoor
Jumbo	27-9/16"	1.54 lb (700 g)	Indoor & Outdoor
Giant	27-9/16"	1.54 lb (700 g)	Indoor & Outdoor



## Quick Snap Standoffs

### Installation 5 Easy Steps

The directions below are general installation recommendations. The weight of each fastener depends on the conditions of use. To avoid unnecessary tension it is advised to avoid over tightening of the body support.

#### Technical Information

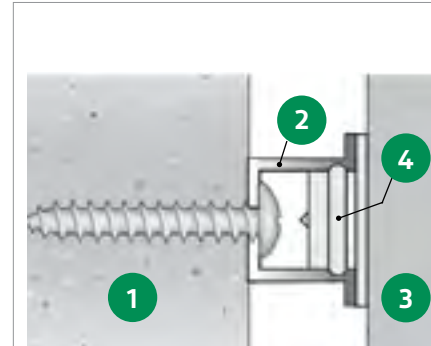

1. Surface
2. Body with screw
3. Letter
4. Head with adhesive

#### Screw Mounted

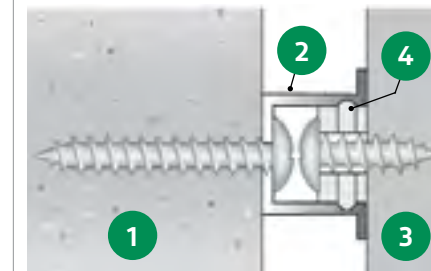

1. Surface
2. Body with screw
3. Letter
4. Head with screw



1

Using the proper adhesive glue the Head support on the back of the letters. Allow for appropriate cure time before mounting letter.



2

Place the letter against the template and use pressure to mark placement of pilot holes.



3

Place template and drill appropriately.



4

Attach Body ends in correct positions.



5

Securely Snap the letters into place using slight pressure.

**PRODUCT INFO**

Snap fasteners can be properly secured by using our Quick Snap adhesive for all letters made from acrylic or expanded PVC, or, by using our 2 component adhesive for letters out of aluminum, brass, stainless or multi layer aluminum enamel.

**SAFETY INSTRUCTIONS**

Always use stainless steel screws. Tighten the screws through the fastener, then loosen a quarter of a turn. The fasteners must be used exclusively for letters. Use one fastener per 4".



## Quick Snap Standoffs



Mini

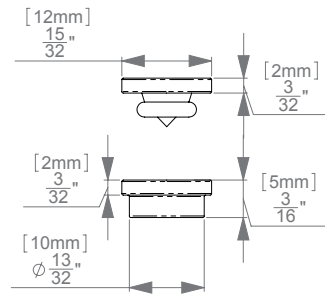

Large / Screw

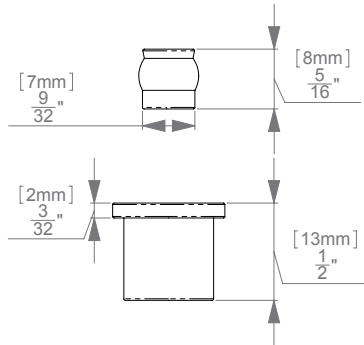

Small

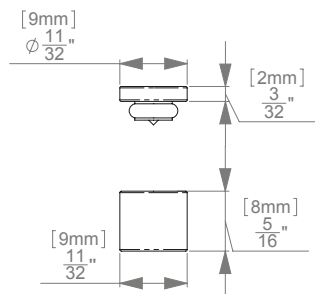

Big

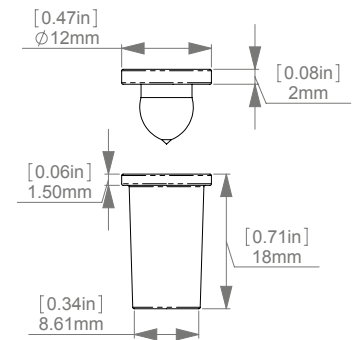

Medium

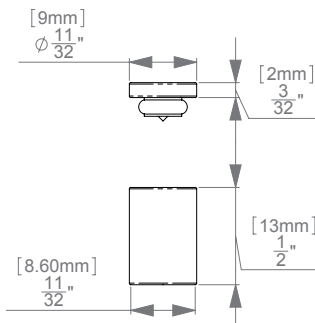

Extra Big

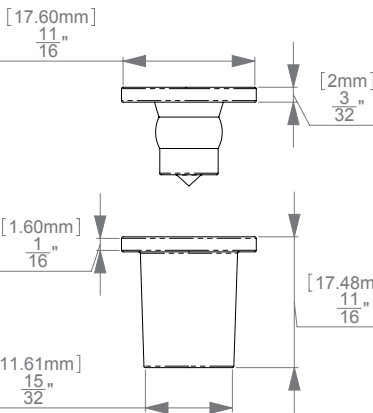

Large

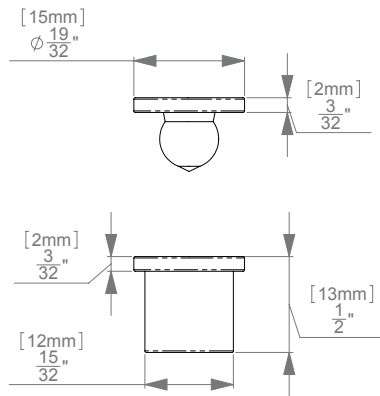

Extra Big/Screw

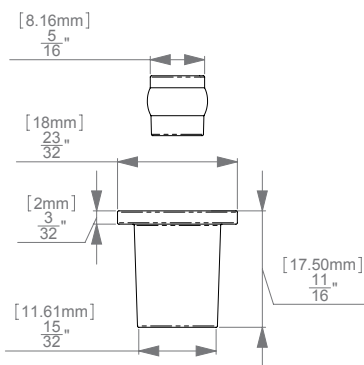

## Quick Snap Standoffs

### Sold by the Unit

Name	Diameter	Rated Strength per Quick Snap	Distance from the wall	Tightening Method	Plastic Black	Plastic White	Plastic Clear
Mini	1/2"	0.55 lbs	1/4"	Adhesive mounted head	QSASB1HK	QSASB2HK	QSASB4HK
Small	3/8"	0.55 lbs	3/8"	Adhesive mounted head	QSBSB1HK	QSBSB2HK	QSBSB4HK
Medium	3/8"	0.55 lbs	1/2"	Adhesive mounted head	QSCSB1HK	QSCSB2HK	QSCSB4HK
Large	5/8"	0.55 lbs	5/8"	Adhesive mounted head	QSDSB1HK	QSDSB2HK	QSDSB4HK
			1/2"	Screw mounted head	QSDSB1HS	QSDSB2HS	QSDSB4HS
Big	1/2"	0.55 lbs	3/4"	Adhesive mounted head	QSESB1HK	QSESB2HK	QSESB4HK
Extra Big	3/4"	0.88 lbs	3/4"	Adhesive mounted head	QSFBS1HK	QSFBS2HK	QSFBS4HK
			3/4"	Screw mounted head	QSFBS1HS	QSFBS2HS	QSFBS4HS
Jumbo	3/4"	1.54 lbs	1"	Adhesive mounted head	QSGSB1HK	QSGSB2HK	QSGSB4HK
			7/8"	Screw mounted head	QSGSB1HS	QSGSB2HS	QSGSB4HS
Giant	3/4"	1.54 lbs	1-1/8"	Adhesive mounted head	QSHSB1HK	QSHSB2HK	QSHSB4HK
			1-1/16"	Screw mounted head	N/A	N/A	QSHSB4HS

### Sold by the Kit of 100



SKU: QS050C



SKU: QS075C



SKU: QS050C



SKU: QS075C

Name	Diameter	Rated Strength per Quick Snap	Distance from the wall	Tightening Method	Clear Polycarbonate
Small	9/16	0.55 lbs	9/16"	Adhesive mounted head	QS050C
Large	3/4"	0.55 lbs	3/4"	Adhesive mounted head	QS075C

### Sample Kit

Assorted sizes for your review.  
Refunded with your first order of 250 pcs or more

SKU: QSSAMPLE



### Glue



Quick Snap Letter System Glue  
0.71 oz (20 gr)

SKU: QSXGLU1



Quick Snap Letter System 2 component Glue  
1.69 fl oz (50 ml)

SKU: QSXGLU2

## Quick Snap Expander Standoffs

- Product** Expander Standoffs
- Unique Features** Indoor Use Only  
Easily Removable  
Adhesive or Screw Mounted
- Area Of Use** Acrylics  
Artworks  
Letter Signs
- Additional Details** TREATED ANTI U.V.  
Standard: V-2 UL 94 temp.  
122 Ca 1.8 Mpa & EN 50107



### Expander I & Expander II

Diameter	Mount	Adjustable Standoff From	Expander I	Expander II
7/8"	Adhesive or screw mounted	1-5/8" to 2-1/8"	QSJSB4H	QLSB4H
Glue QSXGLU1 and QSXGLU2				

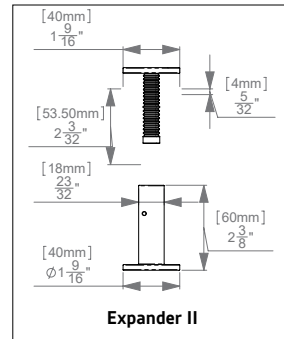
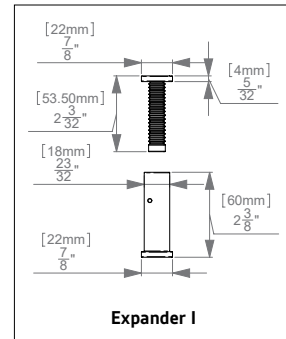

### Expander I XL & Expander II XL

Diameter	Mount	Adjustable Standoff From	Expander I XL	Expander II XL
1-5/8"	Adhesive or screw mounted	2-1/2" to 3-3/8"	QSKSB4H	QSMSB4H
Glue QSXGLU1 and QSXGLU2				

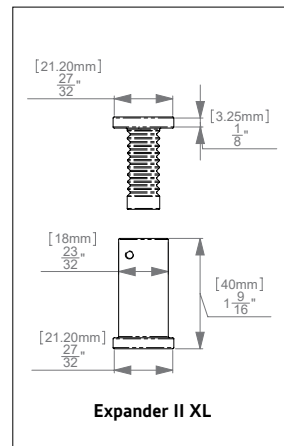
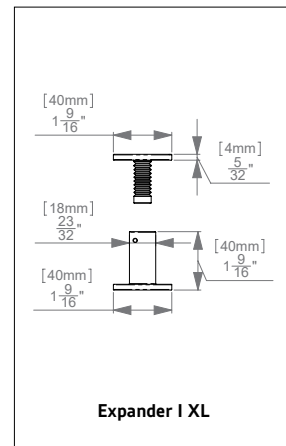

## Studs Full Threaded

304 Stainless Steel and Aluminum Studs for Letter Mounting

Technical Information	Thread	Material	Length	SKU
	#4-40	304 Stainless Steel	1"	SST440-100
			2"	SST440-200
	#6-32	304 Stainless Steel	5/8"	SST632-100
			1"	SST632-100
			1-1/2"	SST632-150
			2"	SST632-200
			3"	SST632-300
			5/8"	SST1024-062
	#10-24	304 Stainless Steel	1"	SST1024-100
			1-1/2"	SST1024-150
			2"	SST1024-200
			3"	SST1024-300
			4"	SST1024-400
			5"	SST1024-500
	1/4-20	304 Stainless Steel	6"	SST1024-600
			1"	SST1420-100
			2"	SST1420-200
			3"	SST1420-300
			4"	SST1420-400
			5"	SST1420-500
	5/16-18	304 Stainless Steel	6"	SST1420-600
			5/8"	SST51618-062
			1"	SST51618-100
			1-1/2"	SST51618-150
			2"	SST51618-200
			3"	SST51618-300
	3/8-16	304 Stainless Steel	4"	SST51618-400
			5"	SST51618-500
			6"	SST51618-600
			4"	SST3816-400
			5"	SST3816-500
			6"	SST3816-600

Technical Information	Thread	Material	Length	SKU
	#6-32	Aluminum	1-1/2"	AST632-150
			2"	AST632-200
	#10-24	Aluminum	1"	AST1024-100
			1-1/2"	AST1024-150
			2"	AST1024-200
			3"	AST1024-300
			4"	AST1024-400
			5"	AST1024-500
	1/4-20	Aluminum	6"	AST1024-600
			2"	AST1420-200
			3"	AST1420-300
			4"	AST1420-400
			5"	AST1420-500
			6"	AST1420-600
	5/16-18	Aluminum	5/8"	AST51618-062
			1"	AST51618-100
			1-1/2"	AST51618-150
			2"	AST51618-200
			3"	AST51618-300
			4"	AST51618-400
	3/8-16	Aluminum	5"	AST51618-500
			6"	AST51618-600





## Button-Fix

**Product** Button-fix

**Unique Features** Indoor Use Only  
Removable  
Push on Assembly  
Slide Down and Up  
Assembly

**Area Of Use** Wall/vertical panels  
Ceiling/horizontal panels  
Shelf/cantilever loading

**Additional Details** We also offer complementary accessories to help make the Button-fix installation quick and easy.



### A Flush Mount Hanging Solution

Button-fix is a hidden flush mount system that allows one to hang signs and panels with ease. Choose from either a screw mounted application or adhesive.



## Button-Fix

### Type 1

- Ideal for acoustic, wall and ceiling panels

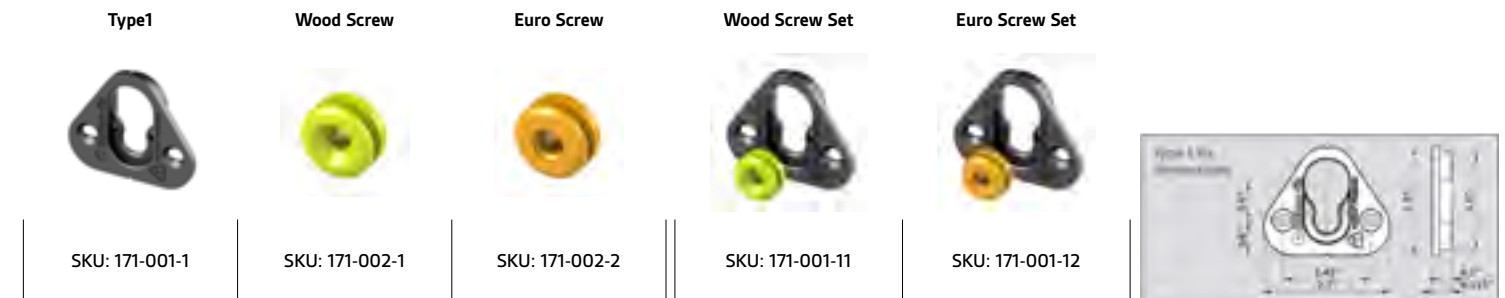

### Type 1 Flush

- Ideal for furniture assembly

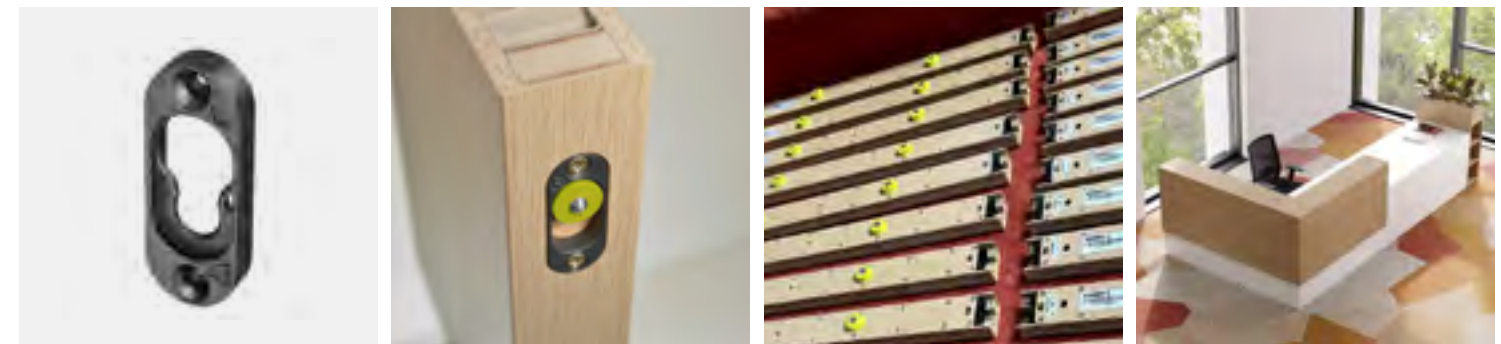



Panel Mounts

### Button-Fix

#### Type 1 Bonded

- Ideal for signage and exhibition displays



Type1 Bonded



SKU: 171-017-1

Wood Screw



SKU: 171-002-1

Euro Screw



SKU: 171-002-2

Wood Screw Set



SKU: 171-017-11

Euro Screw Set



SKU: 171-017-12



Panel Mounts

### Button-Fix

#### Type 2

- Ideal for service access such as bath panels



Type 2 Side Fix



SKU: 171-004-1

Wood Screw



SKU: 171-002-1

Euro Screw



SKU: 171-002-2

Wood Screw Set



SKU: 171-004-11

Euro Screw Set



SKU: 171-004-12

Button-fix Type 2



SKU: 171-004-21



### Type 1 Metal

- Ideal for marine and other transport interiors

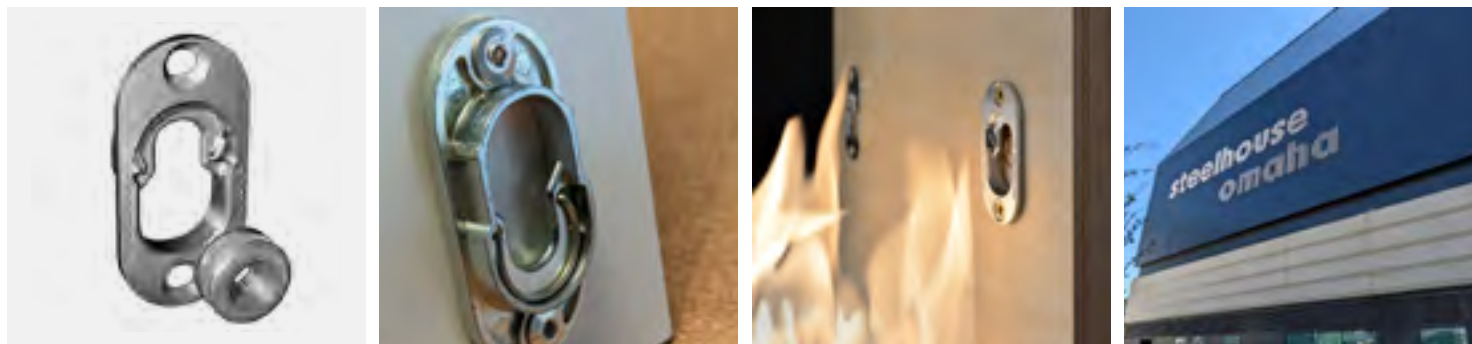

Metal Set



SKU: 171-021-11

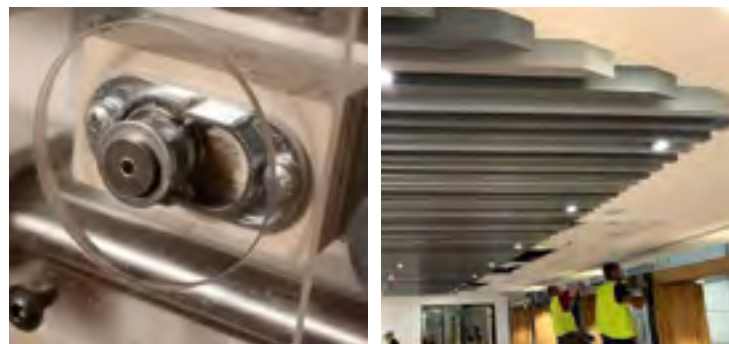
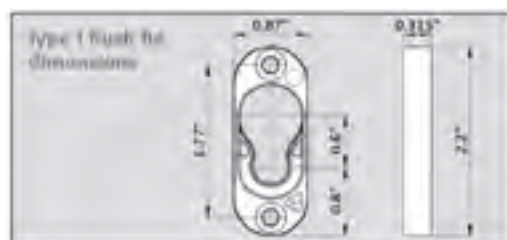

### Type 3

- Ideal for acoustic, wall and ceiling panels



NEW

Type 3



SKU: 171-030-1

NEW

Type 3 Button



SKU: 171-030-2

NEW

Button-fix Type 3



SKU: 171-030-3-K1

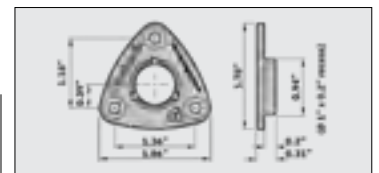



## Button-Fix Sets with Tools

### Type 1 with Wood Screw



Sets	SKU
1	171-001-11
2	171-001-11-K2
4	171-001-11-K4
10	171-001-11-K10
12	171-001-11-K12
20	171-001-11-K20
50	171-001-11-K50
100	171-001-11-K100

### Type 1 with Euro Screw



Sets	SKU
1	171-001-12

### Type 1 with Wood Screw + Marker Tool



Sets	Qty	SKU
2	2	171-001-11-K22
10	1	171-001-11-K101
20	1	171-001-11-K201



### Type 1 Flush with Wood Screw



Sets	SKU
1	171-018-11
2	171-018-11-K2
4	171-018-11-K4
10	171-018-11-K10
12	171-018-11-K12
20	171-018-11-K20
50	171-018-11-K50
100	171-018-11-K100
250	171-018-11-K250

### Type 1 Flush with Euro Screw



Sets	SKU
1	171-018-12

### Type 1 Flush with Wood Screw + Marker Tool



Sets	Qty	SKU
4	1	171-018-11-KT41
10	1	171-018-11-KT101
20	1	171-018-11-KT201

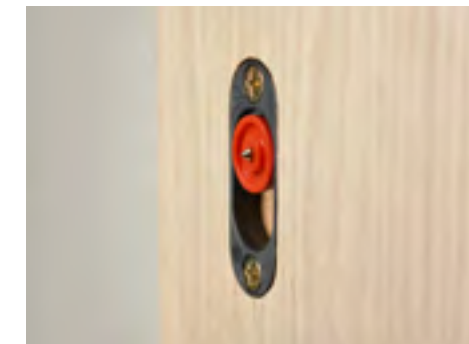

### Type 1 Bonded with Wood Screw



Sets	SKU
1	171-017-11
2	171-017-11-K2
4	171-017-11-K4
10	171-017-11-K10
12	171-017-11-K12
20	171-017-11-K20
50	171-017-11-K50
100	171-017-11-K100
250	171-017-11-K250

### Type 1 Bonded with Euro Screw



Sets	SKU
1	171-017-12

### Type 1 Bonded with Wood Screw + Marker Tool



Sets	Qty	SKU
10	1	171-017-11-K101
20	1	171-017-11-K201



## Button-Fix Sets with Tools

### Type 1 Metal with Wood Screw



Sets	SKU
1	171-021-11
2	171-021-11-K2
4	171-021-11-K4
10	171-021-11-K10
20	171-021-11-K20
30	171-021-11-K30
40	171-021-11-K40
50	171-021-11-K50
60	171-021-11-K60
70	171-021-11-K70
80	171-021-11-K80
90	171-021-11-K90
100	171-021-11-K100

### Type 1 Metal with + Marker Tool



Sets	Qty	SKU
10	10	171-021-11-KT1010
2	2	171-021-11-KT22
4	4	171-021-11-KT44
6	6	171-021-11-KT66
8	8	171-021-11-KT88



### Type 2 with Wood Screw



Sets	SKU
1	171-004-11
2	171-004-21-K2
4	171-004-21-K4
10	171-004-21-K10
12	171-004-21-K12
20	171-004-21-K20
50	171-004-21-K50
100	171-004-21-K100
250	171-004-21-K250

### Type 2 Bonded with Euro Screw



Sets	SKU
1	171-004-21

### Type 2 Metal with + Marker Tool



Sets	Qty	SKU
4	1	171-004-21-KT41
4	2	171-004-21-KT42
4	4	171-004-21-KT44
6	6	171-004-21-KT66
10	1	171-004-21-KT101
10	4	171-004-21-KT104
10	6	171-004-21-KT106
10	10	171-004-21-KT1010
12	1	171-004-21-KT121
12	6	171-004-21-KT126
12	10	171-004-21-KT1210
20	1	171-004-21-KT201
20	10	171-004-21-KT2012
50	10	171-004-21-KT5010
100	10	171-004-21-KT10010
250	10	171-004-21-KT25010
250	50	171-004-21-KT25050

### Type 3



Sets	SKU
1	171-030-3-K1
2	171-030-3-K2
4	171-030-3-K4
10	171-030-3-K10
12	171-030-3-K12
20	171-030-3-K20
50	171-030-3-K50
100	171-030-3-K100
250	171-030-3-K250



## Spacers

**Product** | Spacer Barrels

**Unique Features**

- Indoor
- Outdoor
- 3 Different Materials
- 6 Different Finishes
- 2 Different Diameters
- 8 Different Heights

**Area Of Use**

- Signage
- Wayfinder
- Display
- Advertising
- Sign Lettering

**Additional Details** | Spacing one letter on top of another



### 3/8" Diameter Aluminum Spacers

Outer Diameter	Inner Diameter	Barrel Height	Aluminum Clear (A)	Aluminum Matte Black (MB)	Aluminum Mill (MF)
3/8"	1/4"	1/4"	QSA038-025A	QSA038-025MB	QSA038-025MF
		1/2"	QSA038-050A	QSA038-050MB	QSA038-050MF
		3/4"	QSA038-075A	QSA038-075MB	QSA038-075MF
		1"	QSA038-100A	QSA038-100MB	QSA038-100MF
		1-1/4"	QSA038-125A	QSA038-125MB	QSA038-125MF
		1-1/2"	QSA038-150A	QSA038-150MB	QSA038-150MF
		1-3/4"	QSA038-175A	QSA038-175MB	QSA038-175MF
		2"	QSA038-200A	QSA038-200MB	QSA038-200MF



### 1/2" Diameter Aluminum Spacers

Outer Diameter	Inner Diameter	Barrel Height	Aluminum Clear (A)	Aluminum Matte Black (MB)	Aluminum Mill (MF)
1/2"	1/4"	1/4"	QSA050-025A	QSA050-025MB	QSA050-025MF
		1/2"	QSA050-050A	QSA050-050MB	QSA050-050MF
		3/4"	QSA050-075A	QSA050-075MB	QSA050-075MF
		1"	QSA050-100A	QSA050-100MB	QSA050-100MF
		1-1/4"	QSA050-125A	QSA050-125MB	QSA050-125MF
		1-1/2"	QSA050-150A	QSA050-150MB	QSA050-150MF
		1-3/4"	QSA050-175A	QSA050-175MB	QSA050-175MF
		2"	QSA050-200A	QSA050-200MB	QSA050-200MF



## Spacers

### 3/8" Diameter Polycarbonate Spacers

Outer Diameter	Inner Diameter	Barrel Height	Polycarbonate Clear (C)	Polycarbonate Black (B)	Polycarbonate White (W)
3/8"	1/4"	1/4"	QSS038-025C	QSS038-025B	QSS038-025W
		1/2"	QSS038-050C	QSS038-050B	QSS038-050W
		3/4"	QSS038-075C	QSS038-075B	QSS038-075W
		1"	QSS038-100C	QSS038-100B	QSS038-100W
		1-1/4"	QSS038-125C	QSS038-125B	QSS038-125W
		1-1/2"	QSS038-150C	QSS038-150B	QSS038-150W
		1-3/4"	QSS038-175C	QSS038-175B	QSS038-175W
		2"	QSS038-200C	QSS038-200B	QSS038-200W

### 1/2" Diameter Polycarbonate Spacers

Outer Diameter	Inner Diameter	Barrel Height	Polycarbonate Clear (C)	Polycarbonate Black (B)	Polycarbonate White (W)
1/2"	1/4"	1/4"	QSS050-025C	QSS050-025B	QSS050-025W
		1/2"	QSS050-050C	QSS050-050B	QSS050-050W
		3/4"	QSS050-075C	QSS050-075B	QSS050-075W
		1"	QSS050-100C	QSS050-100B	QSS050-100W
		1-1/4"	QSS050-125C	QSS050-125B	QSS050-125W
		1-1/2"	QSS050-150C	QSS050-150B	QSS050-150W
		1-3/4"	QSS050-175C	QSS050-175B	QSS050-175W
		2"	QSS050-200C	QSS050-200B	QSS050-200W



### 3/8" Diameter Stainless Steel Spacers

Outer Diameter	Inner Diameter	Barrel Height	Stainless Steel Satin Brushed (304)	Stainless Steel Satin Brushed Marine Grade (316)
3/8"	1/4"	1/4"	QSS038-025-304S	QSS038-025-316S
		1/2"	QSS038-050-304S	QSS038-050-316S
		3/4"	QSS038-075-304S	QSS038-075-316S
		1"	QSS038-100-304S	QSS038-100-316S
		1-1/4"	QSS038-125-304S	QSS038-125-316S
		1-1/2"	QSS038-150-304S	QSS038-150-316S
		1-3/4"	QSS038-175-304S	QSS038-175-316S
		2"	QSS038-200-304S	QSS038-200-316S



### 1/2" Diameter Stainless Steel Spacers

Outer Diameter	Inner Diameter	Barrel Height	Stainless Steel Satin Brushed (304)	Stainless Steel Satin Brushed Marine Grade (316)
1/2"	1/4"	1/4"	QSS050-025-304S	QSS050-025-316S
		1/2"	QSS050-050-304S	QSS050-050-316S
		3/4"	QSS050-075-304S	QSS050-075-316S
		1"	QSS050-100-304S	QSS050-100-316S
		1-1/4"	QSS050-125-304S	QSS050-125-316S
		1-1/2"	QSS050-150-304S	QSS050-150-316S
		1-3/4"	QSS050-175-304S	QSS050-175-316S
		2"	QSS050-200-304S	QSS050-200-316S







## Flag Sign Kit

Page 152

## Projecting Systems



Projecting Grippers

142



Projecting Wall Mount Kits

146



Wall Mounted Side Supports

148



Aluminum Projecting Gripper Kits

151



Flag Sign Kit

152

**NEW**  
Products Added



Flag Sign Brackets

153



Material Connectors

154



Projecting Rod Systems

156



Aluminum T-Sign Brackets

158



Aluminum U-Sign Brackets

160



Double L Standing Sign Base

161

## Projecting Grippers

**Product** | Projecting Grippers  
Washer Reinforcements

**Unique Features** | Indoor Use Only  
Stainless Steel and Aluminum  
Anodized For double-sided viewing  
The sleek, neutral finishes

**Area Of Use** | Malls  
Schools  
Hospitals  
Airports  
Office areas

**Additional Details** | No material drilling needed.  
Can be used with washer reinforcement.

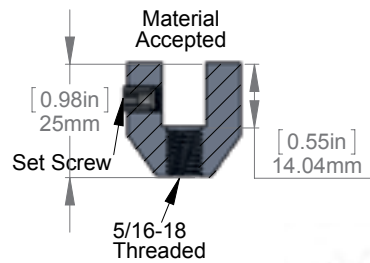

### 7/8" & 1" Diameter



Diameter	Material Thickness Accepted	Aluminum Clear (A)	Aluminum Shiny (AS)	Aluminum Black (B)	Aluminum Gold (G)	Aluminum Bronze (AB)	Aluminum Titanium (T)	Stainless Steel Brushed (S)	Stainless Steel Polished (P)
7/8"	3/16"	PS125A	PS125AS	PS125B	PS125G	PS125AB	PS125T	PS125S	PS125P
7/8"	1/4"	PS250A	PS250AS	PS250B	PS250G	PS250AB	PS250T	PS250S	PS250P
7/8"	3/8"	PS375A	PS375AS	PS375B	PS375G	PS375AB	PS375T	PS375S	PS375P
1"	1/2"	PS500A	PS500AS	PS500B	PS500G	PS500AB	PS500T	PS500S	PS500P

Drywall Hardware: combination screw HB5/16-100 and anchor ANC5, ANC5Z  
Concrete Hardware: combination screw HB5/16-100 and anchor ANC1

### Washer Reinforcement



Diameter	Aluminum Clear (A)	Aluminum Shiny (AS)	Aluminum Black (B)	Aluminum Gold (G)	Aluminum Bronze (AB)	Aluminum Titanium (T)	Stainless Steel Brushed (S)	Stainless Steel Polished (P)
1"	PSW100A	PSW100AS	PSW100B	PSW100G	PSW100AB	PSW100T	PSW100S	PSW100P

Drywall Hardware: combination screw HB5/16-100 and anchor ANC5, ANC5Z  
Concrete Hardware: combination screw HB5/16-100 and anchor ANC1

## Projecting Grippers

**Product** | Projecting Grippers

**Unique Features** | Indoor Use Only  
Stainless Steel and Aluminum  
Anodized For double-sided viewing  
The sleek, neutral finishes

**Area Of Use** | Malls  
Schools  
Hospitals  
Airports  
Office areas

**Additional Details** | Requires a small hole to be drilled through the material.

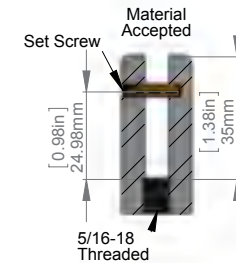

Diameter	Material Thickness Accepted	Aluminum Clear (A)	Aluminum Shiny (AS)	Aluminum Black (B)	Aluminum Gold (G)	Aluminum Bronze (AB)	Aluminum Titanium (T)	Stainless Steel Brushed (S)	Stainless Steel Polished (P)
7/8"	1/4"	PGS250A	PGS250AS	PGS250B	PGS250G	PGS250AB	PGS250T	PGS250S	PGS250P
7/8"	3/8"	PGS375A	PGS375AS	PGS375B	PGS375G	PGS375AB	PGS375T	PGS375S	PGS375P
7/8"	1/2"	PGS500A	PGS500AS	PGS500B	PGS500G	PGS500AB	PGS500T	PGS500S	PGS500P
1"	3/4"	PGS750A	PGS750AS	PGS750B	PGS750G	PGS750AB	PGS750T	PGS750S	PGS750P

Drywall Hardware: combination screw HB5/16-100 and anchor ANC5, ANC5Z  
Concrete Hardware: combination screw HB5/16-100 and anchor ANC1



## Projecting Grippers

- Product** | Projecting Grippers
- Unique Features** | Indoor Use Only  
Stainless Steel and Aluminum Anodized  
For double-sided viewing  
The sleek, neutral finishes
- Area Of Use** | Malls  
Schools  
Hospitals  
Airports  
Office areas
- Additional Details** | No material drilling needed.

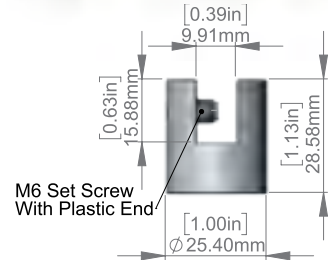

Diameter	Material Thickness Accepted	Aluminum Clear (A)	Aluminum Shiny (AS)	Aluminum Black (B)	Aluminum Gold (G)	Aluminum Bronze (AB)	Aluminum Titanium (T)	Stainless Steel Brushed (S)	Stainless Steel Polished (P)
3/4"	1/4"	HM075-100A	HM075-100AS	HM075-100B	HM075-100G	HM075-100AB	HM075-100T	HM075-100S	HM075-100P
1"	3/8"	HM5010A	HM5010AS	HMS010B	HM5010G	HM5010AB	HM5010T	HM5010S	HM5010P

Drywall Hardware: screw 2208 and anchor ANC5, ANC5Z  
Concrete Hardware: screw 2208 and anchor ANC1

## Projecting Grippers

- Product** | Projecting Grippers
- Unique Features** | Indoor Use Only  
Aluminum Chrome Polished and Satin Chrome Finishes  
For double-sided viewing  
The sleek, neutral finishes
- Area Of Use** | Malls  
Schools  
Hospitals  
Airports  
Office areas
- Additional Details** | No material drilling needed.

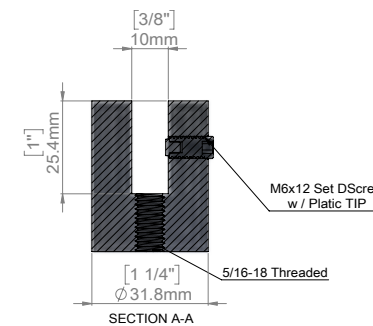

Diameter	Thread	Thickness Material Accepted	Aluminum Chrome Polished (CH)	Aluminum Satin Chrome (SC)
1-1/4"	5/16-18	3/8"	SM38CH	SM38SC

Drywall Hardware: combination screw HB5/16-100 and anchor ANC5, ANC5Z  
Concrete Hardware: combination screw HB5/16-100 and anchor ANC1

## Projecting Gripper Kits

- Product** | Set of 2 Aluminum Projecting Grippers
- Unique Features** | Indoor Use Only  
Stainless Steel and Aluminum Anodized  
For double-sided viewing  
The sleek, neutral finishes
- Area Of Use** | Malls  
Schools  
Hospitals  
Airports  
Office areas
- Additional Details** | No material drilling needed.

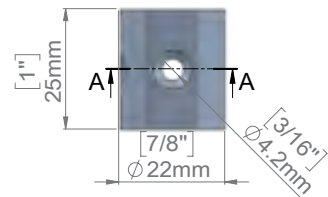

Diameter	Material Thickness Accepted	Aluminum Clear (A)	Aluminum Shiny (AS)	Aluminum Black (B)	Aluminum Gold (G)	Aluminum Bronze (AB)	Aluminum Titanium (T)	Stainless Steel Brushed (SS)	Stainless Steel Polished (SP)
7/8"	1/4" to 3/8"	PS078-100A	PS078-100AS	PS078-100B	PS078-100G	PS078-100AB	PS078-100T	PS078-100SS	PS078-100SP

Drywall Hardware: screw 2208 and anchor ANC5, ANC5Z  
Concrete Hardware: screw 2208 and anchor ANC1

## Projecting Gripper Kits

- Product** | Set of 2 Aluminum Projecting Grippers
- Unique Features** | Indoor Use Only  
Stainless Steel and Aluminum Anodized  
For double-sided viewing  
The sleek, neutral finishes
- Area Of Use** | Malls  
Schools  
Hospitals  
Airports  
Office areas
- Additional Details** | #6 screw and anchors included.  
No material drilling needed.

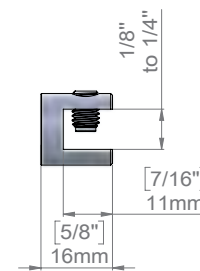

Diameter	Material Thickness Accepted	Comments	Aluminum Clear (A)	Aluminum Shiny (AS)	Aluminum Black (B)	Aluminum Gold (G)	Aluminum Bronze (AB)	Aluminum Titanium (T)	Stainless Steel Brushed (SS)	Stainless Steel Polished (SP)
5/8"	1/8" to 1/4"	Set of 2	WMC058A	WMC058AS	WMC058B	WMC058G	WMC058AB	WMC058T	WMC058SS	WMC058SP

Drywall Hardware: screw 2208 and anchor ANC5, ANC5Z  
Concrete Hardware: screw 2208 and anchor ANC1



## Wall Mounted Side Support

**Product** | Wall mounted side standoff

**Unique Features** | Indoor Use Only  
Stainless Steel  
Satin Brushed  
For double-sided viewing  
The sleek, neutral finishes

**Area Of Use** | Malls  
Schools  
Hospitals  
Airports  
Office areas

**Additional Details** | Requires a small hole to be drilled through the material.

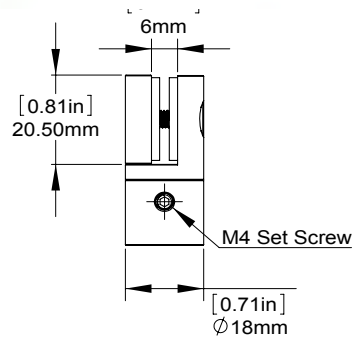

Diameter	Material Thickness Accepted	SKU
----------	-----------------------------	-----

3/8"

1/4"

100.322

Drywall Hardware: screw 2216 and anchor ANC6, ANC6Z  
Concrete Hardware: screw 2216 and anchor ANC2

## Wall Mounted Side Support

**Product** | Wall mounted side standoff

**Unique Features** | Indoor Use Only  
Stainless Steel  
Satin Brushed  
For double-sided viewing  
The sleek, neutral finishes

**Area Of Use** | Malls  
Schools  
Hospitals  
Airports  
Office areas

**Additional Details** | Requires a small hole to be drilled through the material.

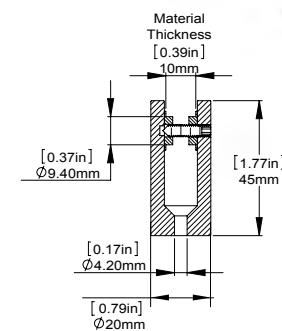

Washer acts as a barrier between material and set screw.



Diameter	Material Thickness Accepted	SKU
----------	-----------------------------	-----

3/8"

3/8"

100.206

Drywall Hardware: screw 2216 and anchor ANC6, ANC6Z  
Concrete Hardware: screw 2216 and anchor ANC2

## Glass Wall Clamping Link

**Product** | Wall mounted side standoff

**Unique Features** | Indoor Use Only  
Stainless Steel  
Satin Brushed  
For double-sided viewing  
The sleek, neutral finishes

**Area Of Use** | Malls  
Schools  
Hospitals  
Airports  
Office areas

**Additional Details** | Requires (2.5mm) allen key.  
No material drilling needed.

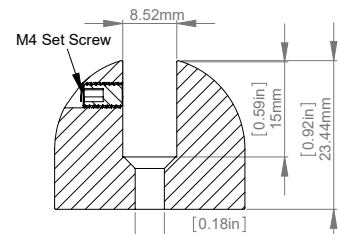

Diameter	Material Thickness Accepted	SKU
2-1/3"	up to 5/16"	100.154

Drywall Hardware: screw 2216 and anchor ANC6, ANC2Z  
Concrete Hardware: screw 2216 and anchor ANC2

## Set of 2 Wall Clamp

**Product** | Set of 2 Wall mounted side standoffs

**Unique Features** | Indoor Use Only  
Stainless Steel  
Satin Brushed  
For double-sided viewing  
The sleek, neutral finishes

**Area Of Use** | Malls  
Schools  
Hospitals  
Airports  
Office areas

**Additional Details** | Requires M2 allen key.  
Requires a small hole to be drilled through the material.

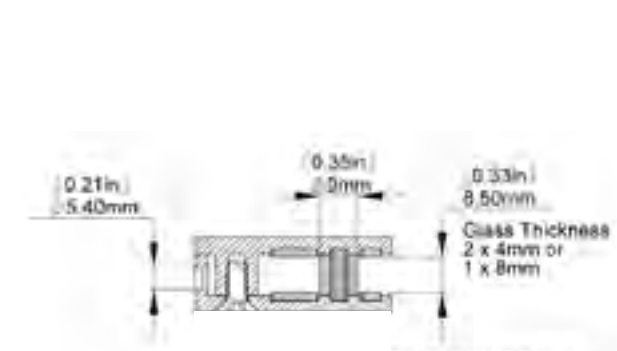

Material Thickness Accepted	SKU
(2) 3/16" or (1) 5/16"	100.320

Drywall Hardware: screw 2216 and anchor ANC6, ANC6Z  
Concrete Hardware: screw 2216 and anchor ANC2





## Flag Sign Kit

### Includes:

- 2 x glasses 7-1/16" x 7-1/16" x 3/16"
- High grade stainless steel round bar
- 2 x point wall attachment
- Insert Sheets: clear, opaque, white

SKU: 160.304

### Art and hardware not included!

Drywall: screw 2216 and anchor ANC6, ANC6Z

Concrete: screw 2216 and anchor ANC2

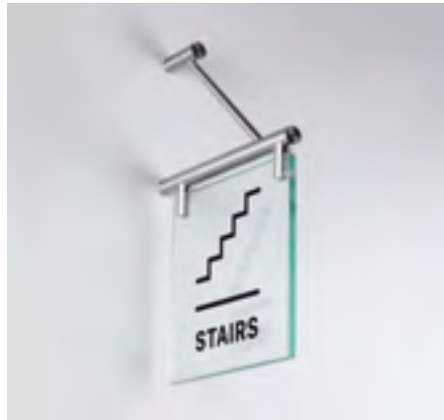

**#1**  
BEST SELLER



## Flag Sign Brackets

Our Projecting Flag Sign Bracket is perfect for all your indoor applications. Set your company apart with beautiful, professional signage and show your customers that you mean business.

\* Sold Without Panel, Bracket Only

### Thickness

Material Accepted : 1/8"



SKU: 160.304-125A



SKU: 160.304-125MB



SKU: 160.304-125SS



Diameter	Length	Thickness Material Accepted	Aluminum Clear (A)	Aluminum Matte Black (MB)	Stainless Steel Satin Brushed (SS)
3/4"	7-7/8"	1/8"	160.304-125A	160.304-125MB	160.304-125SS

## Flag Sign Brackets

Thickness  
Material Accepted : 1/4"



Diameter	Length	Thickness Material Accepted	Aluminum Clear (A)	Aluminum Matte Black (MB)	Stainless Steel Satin Brushed (SS)
3/4"	7-7/8"	1/4"	160.304-250A	160.304-250MB	160.304-250SS

Thickness  
Material Accepted : 5/16"



Diameter	Length	Thickness Material Accepted	Aluminum Clear (A)	Aluminum Matte Black (MB)	Stainless Steel Satin Brushed (SS)
3/4"	7-7/8"	5/16"	160.304-375A	160.304-375MB	160.304-375SS

## Material Connectors

For Indoor Use Only

- Designed from high quality stainless steel and aluminum
- Designed for flat material signs
- 3 Finishes
- 1/4" To 1/2" thick, material accepted



SKU: 100.020

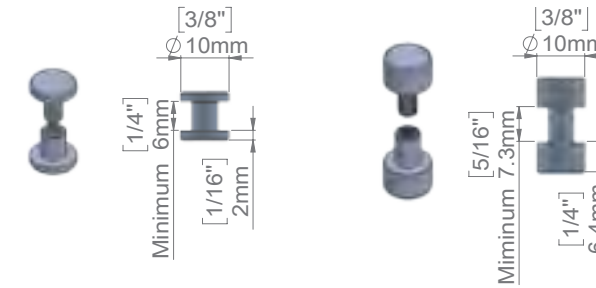

SKU: MCS038

SKU: MC038

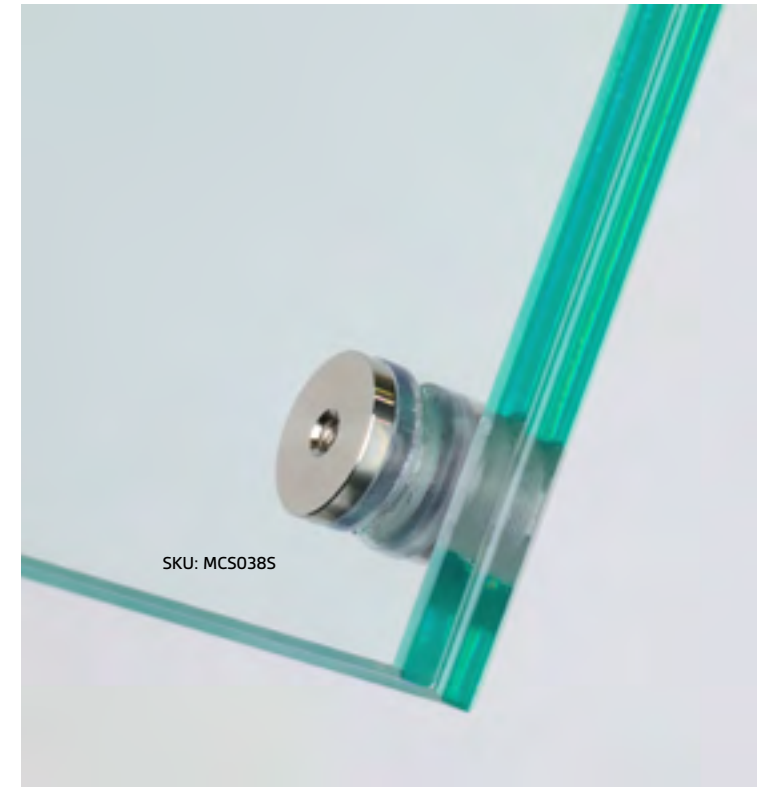
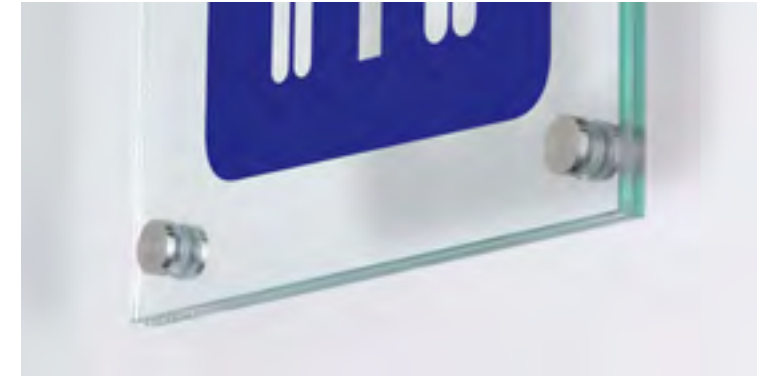

SKU: MCS038S



Diameter	Mounting Diameter	Material Thickness Accepted	Head	Aluminum Clear (A)	Aluminum Black (B)	Stainless Steel Satin Brushed (S)
3/8"	1/4"	5/16" to 1/2"	Flat 1/4" Thick.	MC038A	MC038B	MC038S
3/8"	1/4"	1/4" to 3/8"	Flat 1/16" Thick.	MCS038A	MCS038B	MCS038S
1/2"	3/8"	3/16" to 5/16"	Flat 1/16" Thick.	N/A	N/A	100.020



## Projecting Rod Systems 3/8" Diameter

For Indoor Use Only

- 3/8" Diameter Arm (2x)
- 2 Point wall attachment
- 4 Forks for material up to 5/16" Thick.
- Screws and Anchors included
- Acrylic not included

**Optional:**

- Set of (2) 3 Hole Mounting Plate
- Set of (2) End balls

**PATENT PENDING**



Description	Diameter	Mounting Diameter	Material Thickness Accepted	Material Width Accepted	Aluminum Clear (A)	Aluminum Matte Black (MB)
Set of 2 Projection Rods 2 Mounting and 4 Panel Grippers, Sold Without Acrylic	3/8"	1"	Up to 5/16"	Up to 8"	RPS8A	RPS8MB
				Up to 12"	RPS12A	RPS12MB
				Up to 16"	RPS16A	RPS16MB
				Up to 20"	RPS20A	RPS20MB
				Up to 24"	RPS24A	RPS24MB
(2) Mounting Plates with 3 Holes	1-15/16"	1-15/16"	N/A	N/A	RPSWMA	RPSWMMB
(2) End Ball for Rod	5/16"	3/8"	N/A	N/A	ROD310-REA	ROD310-REMB

Drywall Hardware: screw 2216 and anchor ANC6, ANC6Z  
Concrete Hardware: screw 2216 and anchor ANC2

**Optional:**



**Set of (2)  
3 Hole Mounting Plates**

SKU: RPSWM\*



**Set of (2)  
End balls**

SKU: ROD310-RE\*

## Projecting Rod Systems 3/8" Diameter

For Indoor Use Only

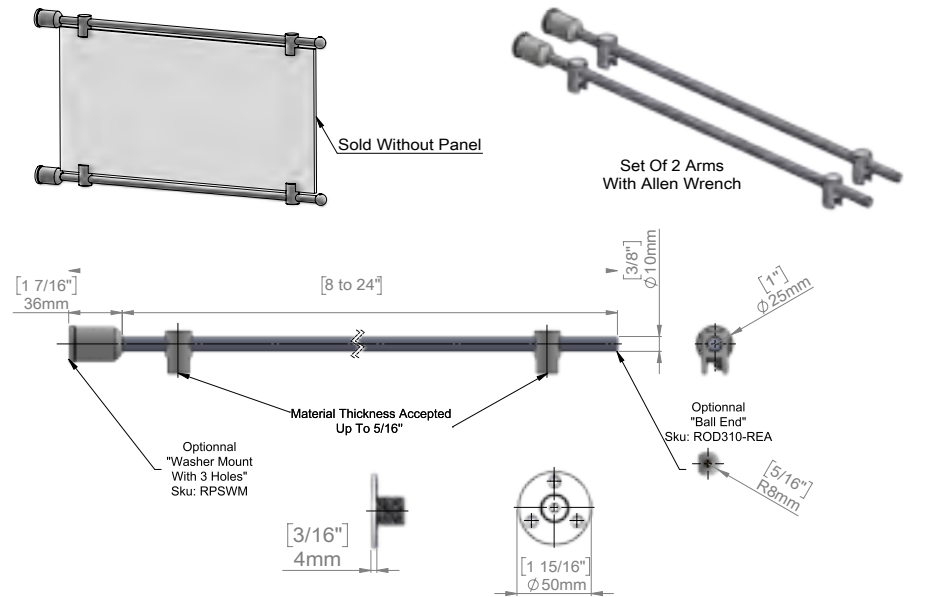
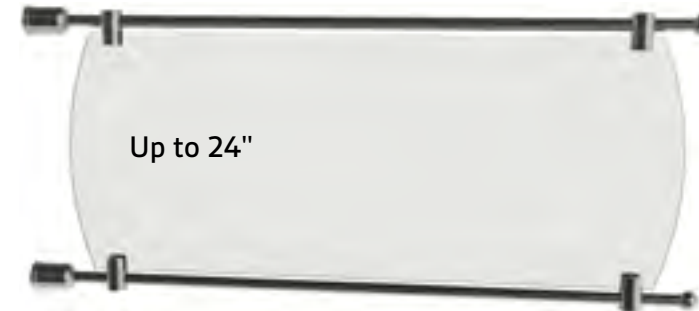
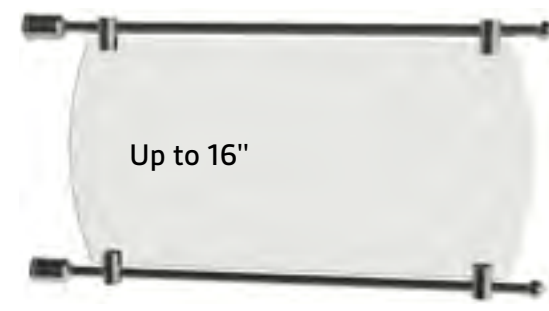
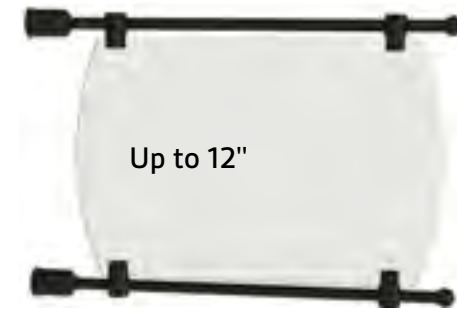

**PATENT PENDING**



**Optional:  
3 Hole Mounting Plates**

## Aluminum T-Sign Brackets

Our aluminum sign T-Brackets are constructed of high-quality materials and provide the sturdy support you need to secure your project. We have a variety of lengths and finishes that can hold either 1/8" or 1/4" material thickness. You can mount the sign brackets to most surfaces to help point people in the right direction.

\* 4 mounting points per bracket.

Art and hardware not included!

Drywall: screw 2216 and anchor ANC6, ANC6Z

Concrete: screw 2216 and anchor ANC2



**#1  
BEST SELLER**



## Aluminum T-Sign Brackets

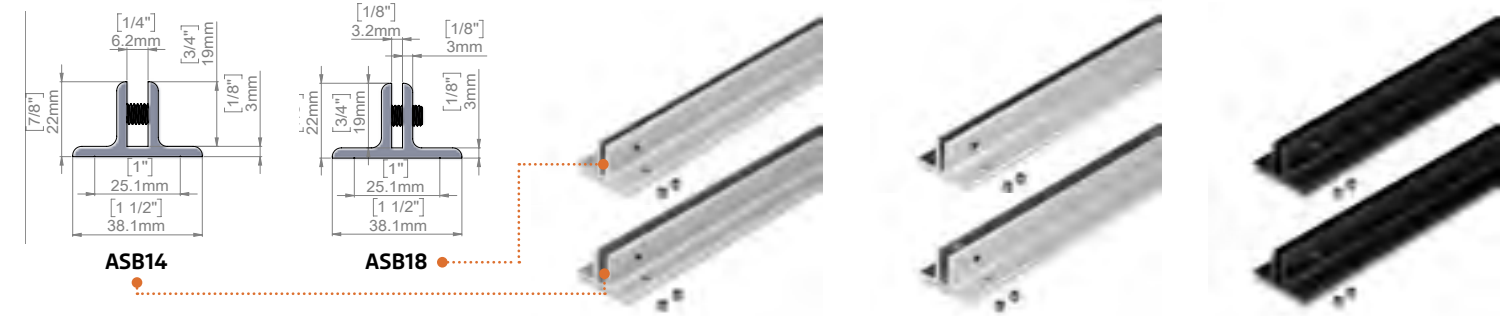

Length	Material Thickness Accepted	Aluminum Clear (A)	Aluminum Polished (AP)	Aluminum Matte Black (MB)
2"	1/4"	ASB14-2A	ASB14-2AP	ASB14-2MB
	1/8"	ASB18-2A	ASB18-2AP	ASB18-2MB
4"	1/4"	ASB14-4A	ASB14-4AP	ASB14-4MB
	1/8"	ASB18-4A	ASB18-4AP	ASB18-4MB
6"	1/4"	ASB14-6A	ASB14-6AP	ASB14-6MB
	1/8"	ASB18-6A	ASB18-6AP	ASB18-6MB
8"	1/4"	ASB14-8A	ASB14-8AP	ASB14-8MB
	1/8"	ASB18-8A	ASB18-8AP	ASB18-8MB
10"	1/4"	ASB14-10A	ASB14-10AP	ASB14-10MB
	1/8"	ASB18-10A	ASB18-10AP	ASB18-10MB
12"	1/4"	ASB14-12A	ASB14-12AP	ASB14-12MB
	1/8"	ASB18-12A	ASB18-12AP	ASB18-12MB
18"	1/4"	ASB14-18A	ASB14-18AP	ASB14-18MB
	1/8"	ASB18-18A	ASB18-18AP	ASB18-18MB
24"	1/4"	ASB14-24A	ASB14-24AP	ASB14-24MB
	1/8"	ASB18-24A	ASB18-24AP	ASB18-24MB

\* Sold with 2x M6x10mm and 2x M6x4mm set screws

36" and above, bracket does not come pre-drilled or pre-tapped and without set screws.



Length	Material Thickness Accepted	Aluminum Clear (A)	Aluminum Polished (AP)	Aluminum Matte Black (MB)
36"	1/4"	ASB14-36A	ASB14-36AP	ASB14-36MB
	1/8"	ASB18-36A	ASB18-36AP	ASB18-36MB
48"	1/4"	ASB14-48A	ASB14-48AP	ASB14-48MB
	1/8"	ASB18-48A	ASB18-48AP	ASB18-48MB
96"	1/4"	ASB14-96A	ASB14-96AP	ASB14-96MB
	1/8"	ASB18-96A	ASB18-96AP	ASB18-96MB



## Aluminum U-Sign Brackets

For Indoor Use Only

Our aluminum sign U-Brackets are constructed of high-quality materials and provide the sturdy support you need to secure your project. We have a variety of lengths and finishes holds 1/4" material thickness. You can mount the sign brackets to most surfaces to help point people in the right direction.

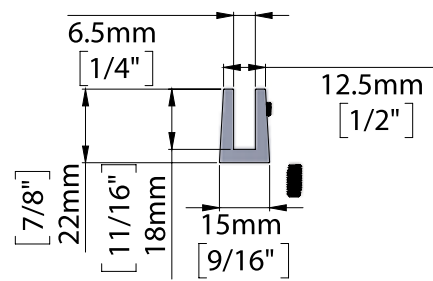

Length	Material Thickness Accepted	Aluminum Clear (A)	Aluminum Polished (CH)	Aluminum Matte Black (MB)
2"	1/4"	APM14-2A	APM14-2CH	APM14-2MB
3"	1/4"	APM14-3A	APM14-3CH	APM14-3MB
4"	1/4"	APM14-4A	APM14-4CH	APM14-4MB
6"	1/4"	APM14-6A	APM14-6CH	APM14-6MB
8"	1/4"	APM14-8A	APM14-8CH	APM14-8MB

## Double L Standing Sign Base

For Indoor Use Only

Use This Beautifully Designed Standing Sign Base to Create an Incredible and Portable Sign Display!

- Maximum panel thickness accepted: 3/4"
- Sizes: 14" x 14" x 4"
- Weight: 3.6 lbs
- SKU: PS370

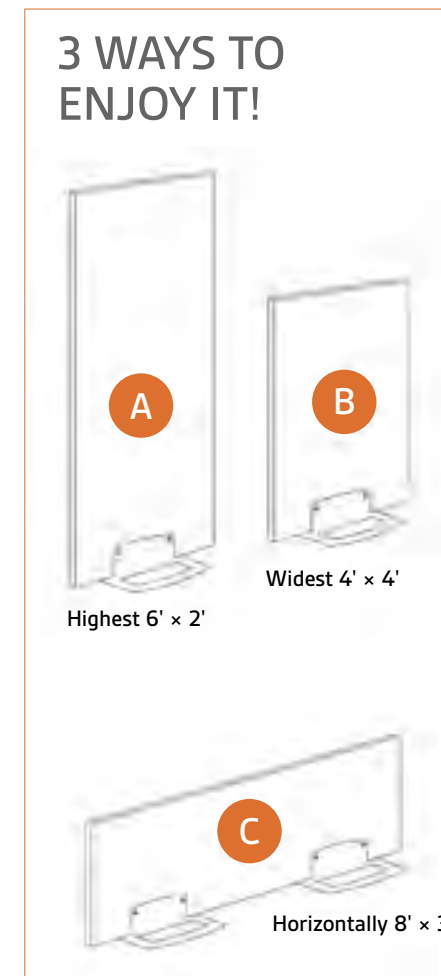

### Installation

1. Unscrew the caps from the base and remove the steel retaining panel. Place your material against the sign base and thread your screws through your material.
2. Place the steel retaining panel on the other side of your material, slide the screws through, and tighten the caps until snug.
3. Take a step back and admire your gorgeous display!

\*Sold Without Panel





## Suspended Systems

	Suspended Systems Selection Guide	164		Ceiling Mount Suspended System Kits with Forks	174
	Self-Gripping Ceiling Mounted Aluminum Suspended System	166		Ceiling Mount Suspended System Kits with Hooks	175
	Self-Gripping Ceiling Mounted Aluminum Suspended System	167		Suspended System Parts	176
	Suspended Double Cable Kits	168		Suspended Rod Kits	180
	Suspended Single Cable Kits	169		Rod Banner Hanger	182
	Drop Ceiling Suspended System Kits	171		Hooks for Stainless Steel and Nylon Cable	183
	Top Mount Wire Suspension Kits for Signage	172		Sign Hangers for Panels & Brackets	184
	Wire Suspension Kits for Signage	173			

**NEW**

Products Added

**NEW**

Products Added



# AFFORDABLE SUSPENDED SYSTEM KITS

# PREMIUM SUSPENDED SYSTEM KITS



**Self-Gripping Ceiling Mounted Aluminum Suspended System Kit**

Set of 2 Kit  
Hardware Not Included

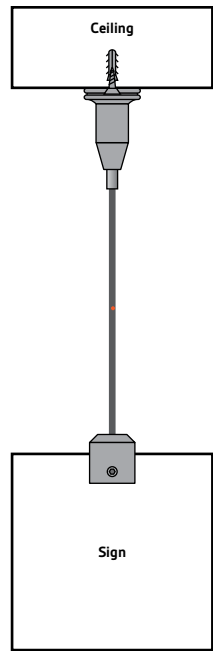

Available in  
Brass Steel

Weight Load:  
55 lbs (25 Kg)  
per Steel Cable  
(When Properly Installed)

Page 164



**Suspended Single Cable Kits**

Set of 1 Kit  
Hardware Included

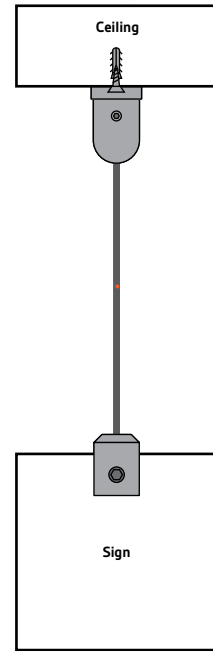

Available in  
Aluminum & Stainless Steel

Weight Load:  
55 lbs (25 Kg)  
per Steel Cable  
(When Properly Installed)

Page 167



**Suspended Single Cable Kits**

Set of 1 Kit  
Hardware included

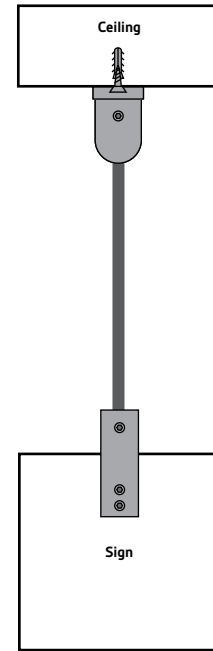

Available in  
Stainless Steel

Weight Load:  
55 lbs (25 Kg)  
per Steel Cable  
(When Properly Installed)

Page 168



**Suspended Double Cable Kits**

Set of 2 Kit  
Hardware included

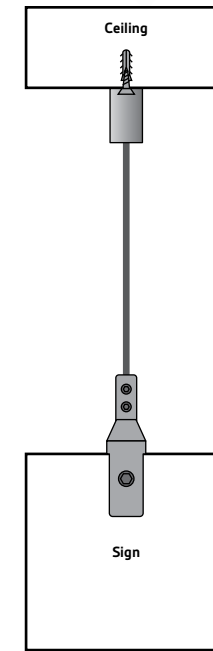

Available in  
Aluminum & Stainless Steel

Weight Load:  
55 lbs (25 Kg)  
per Steel Cable  
(When Properly Installed)

Page 166



**Ceiling Mount Suspended System Kits with Hooks**

Set of 2 Kit  
Hardware Not Required

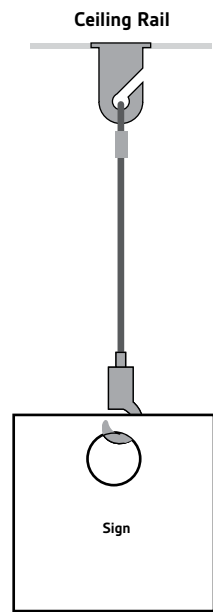

Available in  
Stainless Steel

Weight Load:  
55 lbs (25 Kg)  
per Steel Cable  
(When Properly Installed)

Page 173



**Self-Gripping Ceiling Mounted Aluminum Suspended System**

Set of 2 Kit  
Hardware included

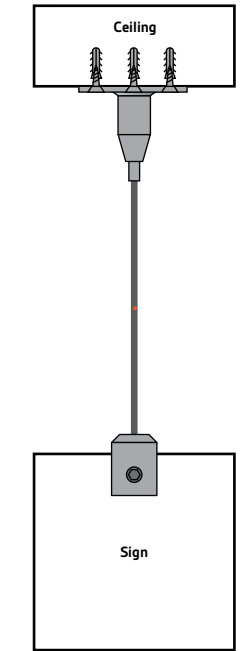

Available in  
Aluminum & Stainless Steel

Weight Load:  
55 lbs (25 Kg)  
per Steel Cable  
(When Properly Installed)

Page 165



**Drop Ceiling Suspended System Kits**

Set of 2 Kit  
Hardware included

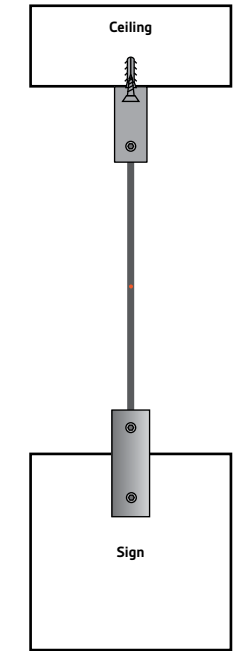

Available in  
Aluminum

Weight Load:  
55 lbs (25 Kg)  
per Steel Cable  
(When Properly Installed)

Page 169



**Top Mount Wire Suspension Kits for Signage**

Set of 1 & 2 Kit  
Hardware Included

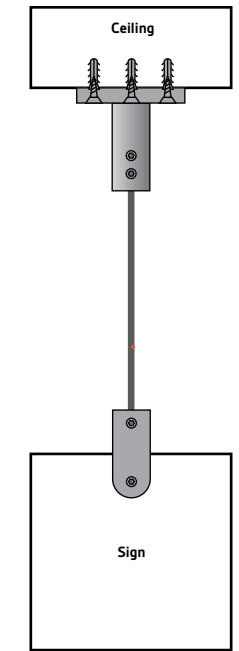

Available in  
Aluminum

Weight Load:  
55 lbs (25 Kg)  
per Steel Cable  
(When Properly Installed)

Page 170



**Wire Suspension Kits for Signage**

Set of 2 Kit  
Hardware Not Included

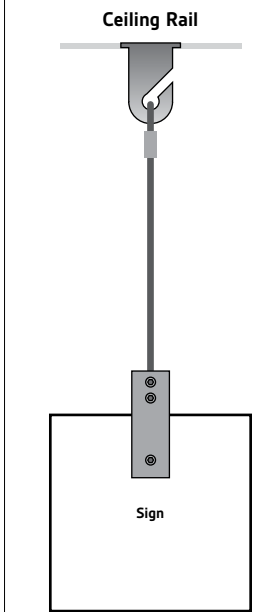

Available in  
Aluminum

Weight Load:  
55 lbs (25 Kg)  
per Steel Cable  
(When Properly Installed)

Page 171



**Ceiling Mount Suspended System Kits with Forks**

Set of 2 Kit  
Hardware included

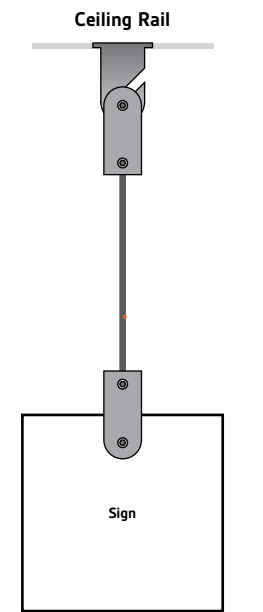

Available in  
Aluminum & Stainless Steel

Weight Load:  
55 lbs (25 Kg)  
per Steel Cable  
(When Properly Installed)

Page 172

## Self-Gripping Ceiling Mounted Aluminum Suspended System

- Product**
  - 2 x Ceiling Mounts
  - 2 x Cables
  - 2 x Hanging Forks
- Unique Features**
  - Indoor Use Only
  - Automatic push to adjust mechanism
- Area Of Use**
  - Signage
  - Wayfinder
  - Display
  - Advertising
- Additional Details**
  - Hardware Not Included



Cable Length	Material Thickness Accepted	Brass Steel
24"	1/4"	SUSKIT1

## Self-Gripping Ceiling Mounted Aluminum Suspended System

- Product**
  - 2 x Ceiling Mounts
  - 2 x Cables
  - 2 x Hanging Forks
- Unique Features**
  - Indoor Use Only
  - 2 Different Materials
  - 2 Different Finishes
  - Automatic push to adjust mechanism
- Area Of Use**
  - Signage
  - Wayfinder
  - Display
  - Advertising
- Additional Details**
  - Hardware Included



Cable Length	Material Thickness Accepted	Aluminum Clear (A)	Stainless Steel Satin Brushed (SS)
76"	1/8" to 5/16"	ACA1660-K2	SCA1660-K2



## Suspended Double Cable Kits

**Product**  
 2 x Ceiling Mounts  
 2 x Cables  
 2 x Hanging Forks

**Unique Features**  
 Indoor  
 2 Different Finishes  
 Clear  
 Black

**Area Of Use**  
 Signage  
 Wayfinder  
 Display  
 Advertising

**Additional Details**  
 Hardware Included

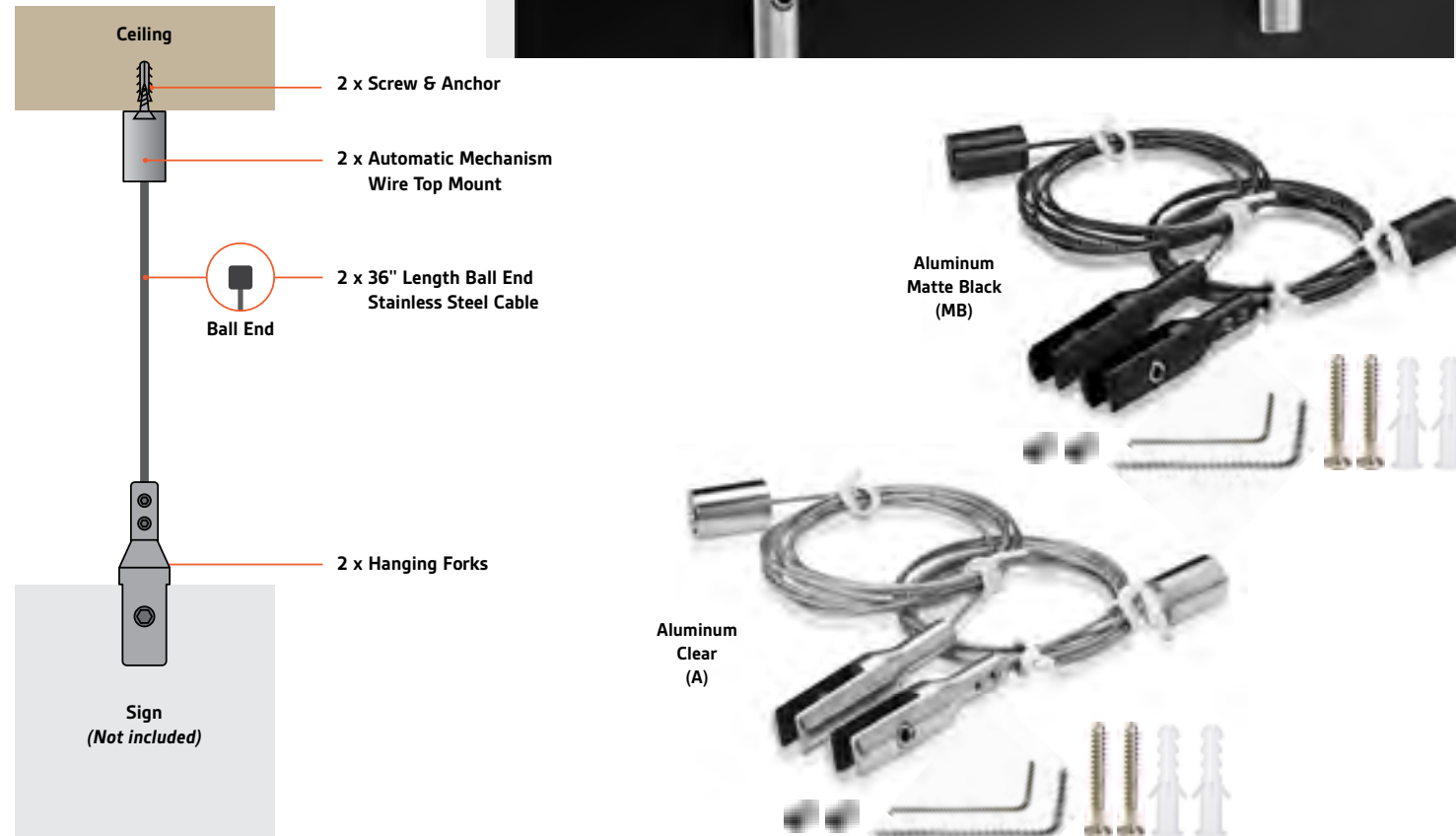

Cable Length	Material Thickness Accepted	Aluminum Clear (A)	Aluminum Matte Black (MB)
36"	0 to 1/4"	SUSKIT2A	SUSKIT2MB

## Suspended Single Cable Kit

**Product**  
 1 x Ceiling Mounts  
 1 x Cables  
 1 x Hanging Forks

**Unique Features**  
 Indoor Use Only  
 2 Different Materials  
 2 Different Finishes

**Area Of Use**  
 Signage  
 Wayfinder  
 Display  
 Advertising

**Additional Details**  
 Included Hardware



Cable Length	Material Thickness Accepted	Aluminum Clear (A)	Stainless Steel Satin Brushed (SS)
78"	minimum 1/8" maximum 5/16"	ACG1902	SCG1902

## Suspended Single Cable Kit

- Product**
  - 1 x Ceiling Mount
  - 1 x Cable
  - 1 x Hanging Fork
- Unique Features**
  - Indoor
  - Heavy Duty
- Area Of Use**
  - Signage
  - Wayfinder
  - Display
  - Advertising
- Additional Details**
  - Hardware included

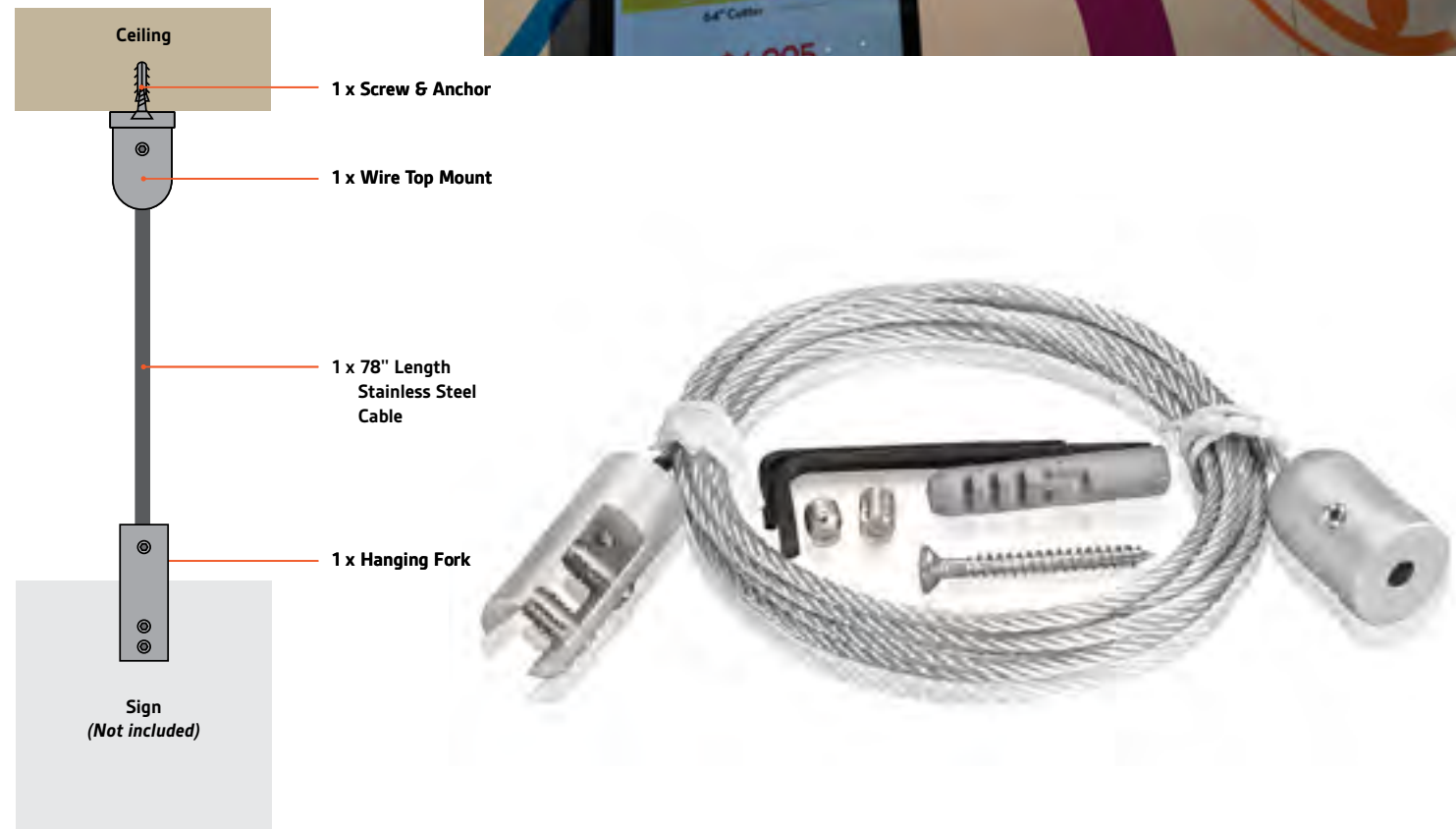

Cable Length	Material Thickness Accepted	Heavy Duty Aluminum Clear (A)
78"	1/8" to 5/16"	ACG1902HD
78"	1/8" to 1/2"	ACG31902

## Drop Ceiling Suspended System Kits

- Product**
  - 2 x Ceiling Mount
  - 2 x Cable
  - 2 x Hanging Forks
- Unique Features**
  - Indoor
  - 2 Different Cable Lengths
- Area Of Use**
  - Signage
  - Wayfinder
  - Display
  - Advertising
- Additional Details**
  - Sold as Set of 2 Kits

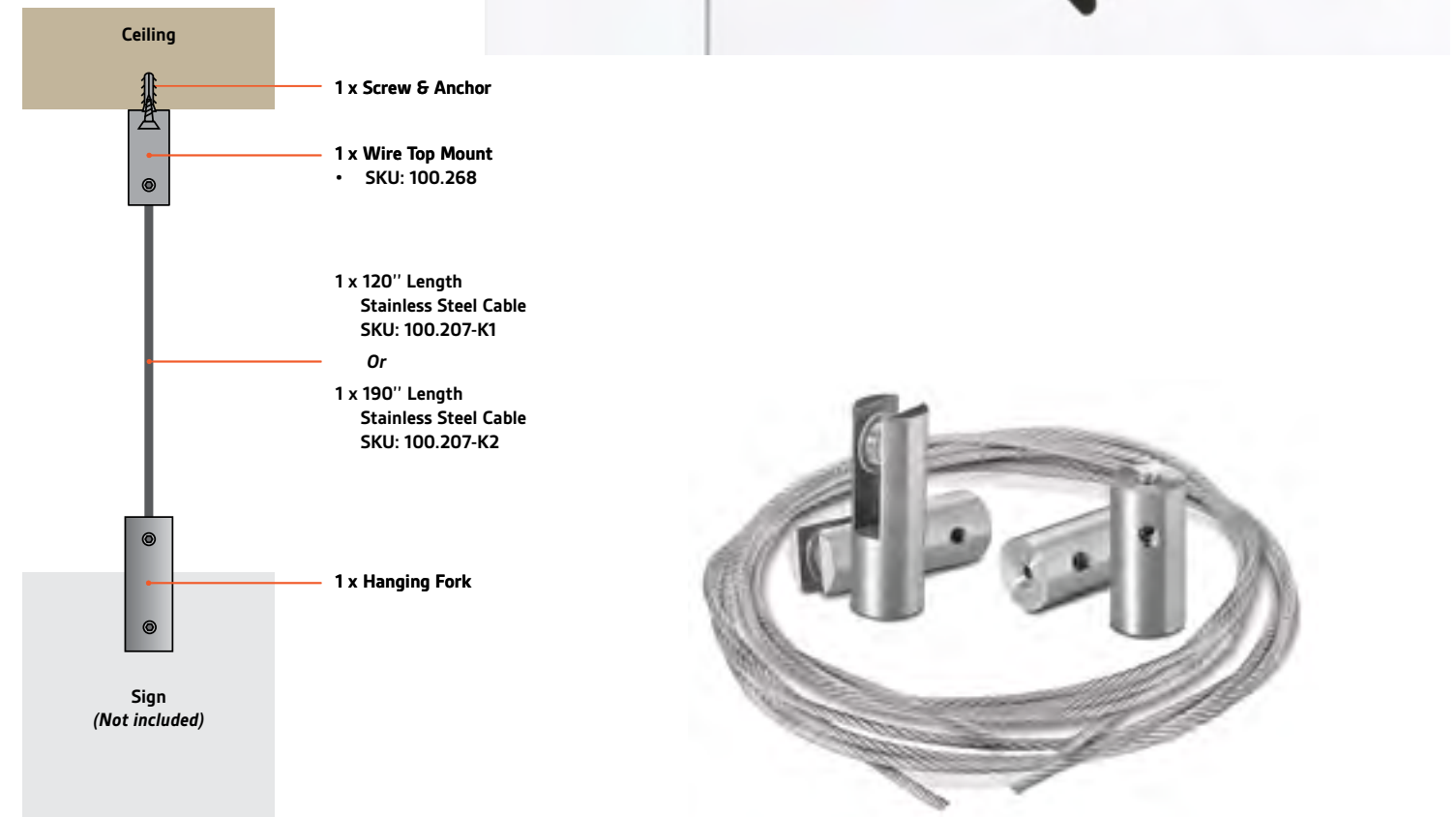
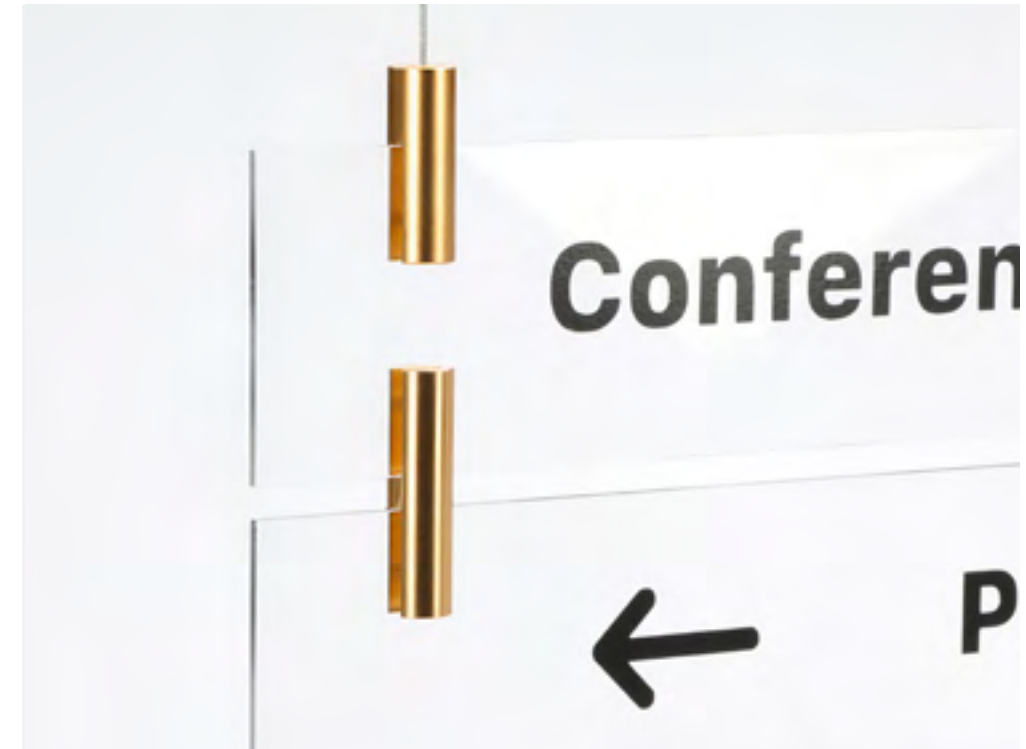

Cable Length	Material Thickness Accepted	Aluminum Clear (A)
120"	1/8" to 5/16"	100.207-K1
190"	1/8" to 5/16"	100.207-K2



## Top Mount Wire Suspension Kits for Signage

- Product**
- Ceiling Mounts
  - 10' Cables
  - Hanging Forks
  - Screws & Anchors
- Unique Features**
- Indoor
  - Light Duty
  - Heavy Duty
- Area Of Use**
- Signage
  - Wayfinder
  - Display
  - Advertising
- Additional Details**
- Cut your cable to fit your display.
  - Requires 3/32" allen key (SKU: ALLENK3/32)

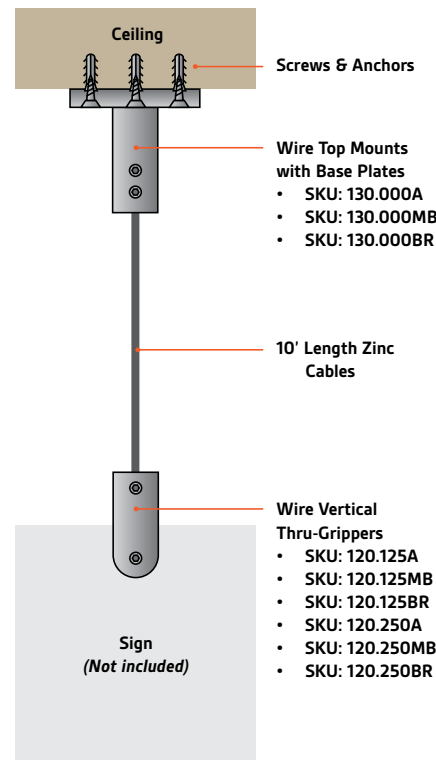

### Set of 1 Kits



### Set of 2 Kits



Set of	Cable Length	Material Thickness Accepted	Aluminum Clear (A)	Aluminum Matte Black (MB)	Aluminum Champagne (BR)
1 x (no hardware)	10'	1/8"	130.125A	130.125MB	130.125BR
	10'	1/4"	130.250A	130.250MB	130.250BR
2 x (hardware included)	10'	1/8"	130.125A-KIT	130.125MB-KIT	130.125BR-KIT
	10'	1/4"	130.250A-KIT	130.250MB-KIT	130.250BR-KIT

## Wire Suspension Kits for Signage

- Product**
- 2 x TClamp1
  - 2 x Ceiling Mount
  - 1 x 10' Cable
  - 4 x Hanging Forks
- Unique Features**
- Indoor
  - Light Duty
  - Heavy Duty
- Area Of Use**
- Signage
  - Wayfinder
  - Display
  - Advertising
- Additional Details**
- Cut your cable to fit your display.
  - Requires 3/32" allen key (SKU: ALLENK3/32)

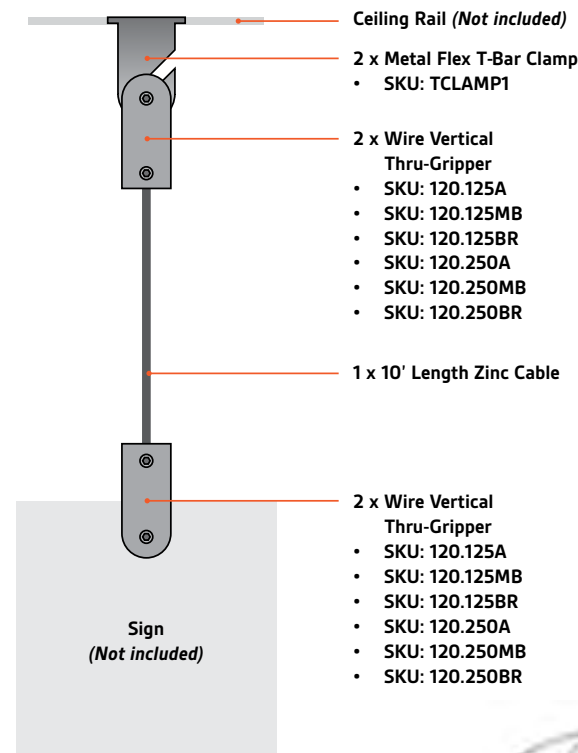

Cable Length	Material Thickness Accepted	Aluminum Clear (A)	Aluminum Matte Black (MB)	Aluminum Champagne (BR)
10'	1/8"	TCLAMP1-125A	TCLAMP1-125MB	TCLAMP1-125BR
10'	1/4"	TCLAMP1-250A	TCLAMP1-250MB	TCLAMP1-250BR

## Ceiling Mount Suspended System Kits with Forks

- Product**
- 2 x TClamps
  - 2 x Cables
  - 2 x Hanging Forks
- Unique Features**
- Indoor
  - 4 Different Cable Lengths
  - 6 Different Finishes
  - 2 Different Weight Loads
- Area Of Use**
- Signage
  - Wayfinder
  - Display
  - Advertising
- Additional Details**
- Goes thru material M4x10mm set screw



### What's Included

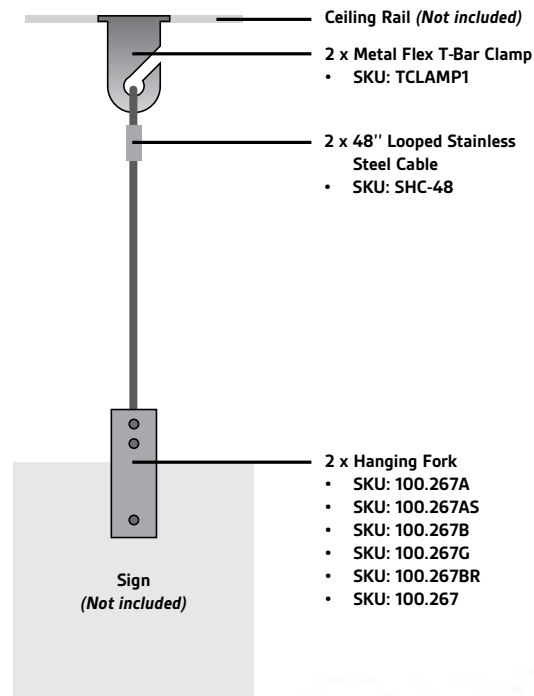

Cable Length	Material Thickness Accepted	Aluminum Clear (AK)	Aluminum Shiny (ASK)	Aluminum Black (BK)	Aluminum Gold (GK)	Aluminum Champagne (BR)	Stainless Steel Satin Brushed (SSK)
48"	1/4"	SHC-48-AK	SHC-48-ASK	SHC-48-BK	SHC-48-GK	SHC-48-BR	SHC-48-SSK
72"		SHC-72-AK	SHC-72-ASK	SHC-72-BK	SHC-72-GK	SHC-72-BR	SHC-72-SSK
96"		SHC-96-AK	SHC-96-ASK	SHC-96-BK	SHC-96-GK	SHC-96-BR	SHC-96-SSK
120"		SHC-120-AK	SHC-120-ASK	SHC-120-BK	SHC-120-GK	SHC-120-BR	SHC-120-SSK

M4 or 2mm allen key needed

## Ceiling Mount Suspended System Kits with Hooks

- Product**
- 2 x TClamps
  - 2 x Cables
  - 2 x Hanging Hooks
- Unique Features**
- Indoor
  - 4 Different Cable Lengths
  - Self Locking
- Area Of Use**
- Signage
  - Wayfinder
  - Display
  - Advertising
- Additional Details**
- While pressing down the button on the top of the hook, simply thread the cable through the hook, and release the button when at the desired length.



### What's Included

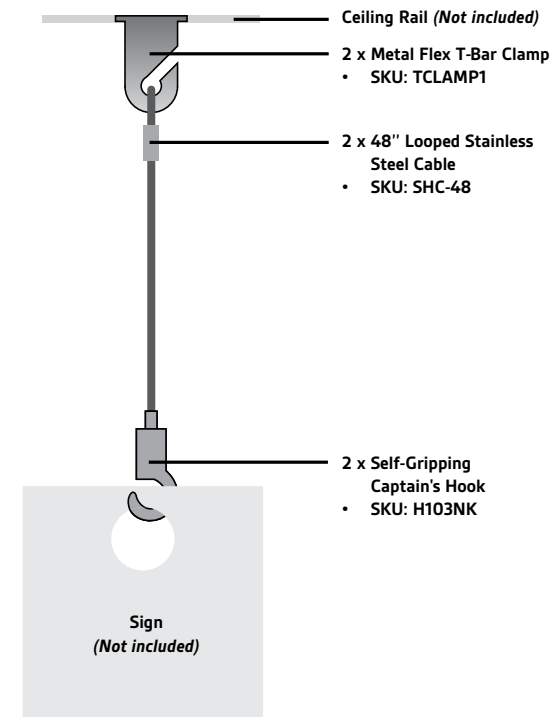

Cable Length	Cable Diameter	Stainless Steel (SS)
48"	1/16"	SK15-48
72"		SK15-72
96"		SK15-96
120"		SK15-120



## Suspended System Parts

### Ceiling Mounts



SKU: 100.268



SKU: 100.268A  
SKU: 100.268B  
SKU: 100.268G



SKU: 110.000



SKU: 110.100



SKU: 100.383  
SKU: 100.385  
SKU: 100.391

Finish	Cable Grip Method	Diameter	Cable Diameter	SKU
Satin Brushed	Tightening Set Screw	5/8"	1/8"	100.268
Anodized Aluminum	Tightening Set Screw	5/8"	1/8"	100.268A/B/AS/G
Nickel	Self-Gripping	N/A	1/8"	110.000
Nickel	Self-Gripping for Aluminum Profile	N/A	1/8"	110.100
Stainless Steel Cable Diameter: 1/16" Length 9' 10" (118"). Maximum weight supported: 55 lbs (25 kg)				100.383
Stainless Steel Cable Diameter: 1/16" Length 16' 4" (196"). Maximum weight supported: 55 lbs (25 kg)				100.385
Galvanized Steel Cable: 1/16" Length 6' (72"). Maximum weight supported: 55 lbs (25 kg)				100.390
Galvanized Steel Cable Diameter: 1/16" Length 16' 4" (196"). Maximum weight supported: 55 lbs (25 kg)				100.391



### Aluminum T-Clamp

Material	Finish	SKU
Aluminum	Steel Painted White	TCLAMP

\* Use Tclamp to attach to drop ceiling. Then flip hanging fork upside down to attach to clamp or use looper cable.



### Aluminum T-Clamp

Material	Finish	SKU
Aluminum	Steel Painted White	TCLAMP1

\* Use Tclamp to attach to drop ceiling. Then flip hanging fork upside down to attach to clamp or use looper cable.



### Acrylic T-Clamp

Material	Finish	SKU
Plastic	Clear Acrylic	TCLAMP2

\* Use Tclamp to attach to drop ceiling. Then flip hanging fork upside down to attach to clamp or use looper cable.

## Suspended System Parts



### Wire Top Mount With Base Plates

Diameter	Cable Diameter	Height	Aluminum Clear (A)	Aluminum Matte Black (MB)	Aluminum Champagne (BR)
2"	1/16"	1-3/16"	130.000A	130.000MB	130.000BR



NEW



NEW



NEW

Drywall Hardware: screw 2208 and anchor ANC5, ANC5Z  
Concrete Hardware: screw 2208 and anchor ANC1

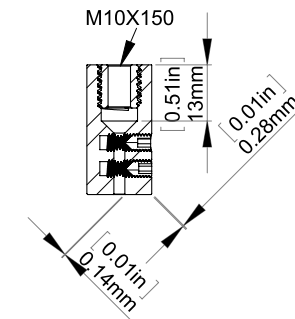

Aluminum Clear (A)



Aluminum Shiny (AS)



Aluminum Black (B)



Aluminum Gold (G)



NEW

Aluminum Champagne (BR)



Stainless Steel Brushed (SS)

### Ceiling Mounted Material Holders

Diameter	Cable Diameter	Mounting Diameter	Aluminum Clear (A)	Aluminum Shiny (AS)	Aluminum Black (B)	Aluminum Gold (G)	Aluminum Champagne (BR)	Stainless Steel Brushed (SS)
5/8"	1/16"	3/8"	100.268A	100.268AS	100.268B	100.268G	100.268BR	100.268

Drywall Hardware: screw 2208 and anchor ANC5, ANC5Z  
Concrete Hardware: screw 2208 and anchor ANC1

## Suspended System Parts



**Looped Nylon Cable**

Diameter	Length: 48"	Length: 72"	Length: 96"	Length: 120"
1/16"	NHC-48	NHC-72	NHC-96	NHC-120



**Looped Stainless Steel Cable**

Diameter	Length: 48"	Length: 72"	Length: 96"	Length: 120"
1/16"	SHC-48	SHC-72	SHC-96	SHC-120



**Stainless Steel Cable**

Diameter	Length	SKU
1/16"	9' 10" (118")	100.383
	16' 4" (196")	100.385



**Galvanized Steel Cable**

Diameter	Length	SKU
1/16"	6' (72")	100.390
	16' 4" (196")	100.391
	10,500ft	GC116-43*

\* Special Order Item

**Steel Wire Cutter**



Our heavy duty Cable Cutter is designed to cut high tensile strength wires and cables up to 3/16" (3mm) in diameter. Optimal to avoid cables fraying.

SKU: CABLECUTTER

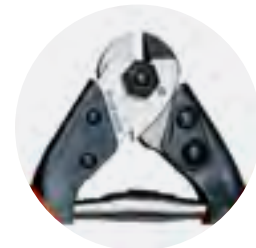

## Suspended System Parts



**Vertical Thru-Bolt Gripper**

Diameter	Cable Diameter	Height	Material Thickness Accepted	Aluminum Clear (A)	Aluminum Matte Black (MB)	Aluminum Champagne (BR)
5/8"	1/16"	1-3/8"	3/16"	120.125A	120.125MB	120.125BR
	1/16"	1-3/8"	1/4"	120.250A	120.250MB	120.250BR

**Hanging Forks**

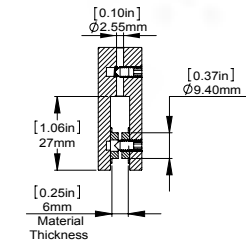

Diameter	Cable Diameter	Mounting Diameter	Material Thickness Accepted	Aluminum Clear (A)	Aluminum Shiny (AS)	Aluminum Black (B)	Aluminum Gold (G)	Aluminum Champagne (BR)	Stainless Steel Brushed (SS)
5/8"	1/16"	3/8"	1/4"	100.267A	100.267AS	100.267B	100.267G	100.267BR	100.267
	1/16"	3/8"	5/16"	100.287A	100.287AS	100.287B	100.287G	N/A	100.287
	1/16" to 1/8"	3/8"	3/8"	N/A	N/A	N/A	N/A	N/A	100.207

**Double Sided Hanging Forks**

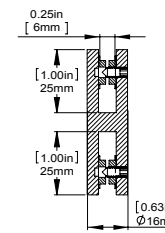

Diameter	Cable Diameter	Mounting Diameter	Material Thickness Accepted	Aluminum Clear (A)	Aluminum Shiny (AS)	Aluminum Black (B)	Aluminum Gold (G)	Aluminum Champagne (BR)	Brushed Stainless Steel (SS)
5/8"	N/A	3/8"	1/4"	100.269A	100.269AS	100.269B	100.269G	100.269BR	100.269



## Suspended Rod Kits

- Panel Thickness: minimum 1/8", maximum 5/16"
- Suspended Kit Includes:
- (1) Ceiling mount
- (1) Aluminum rod diameter: 1/4"
- (1) Panel mount holder
- Screws and Anchors
- Mounting hardware included

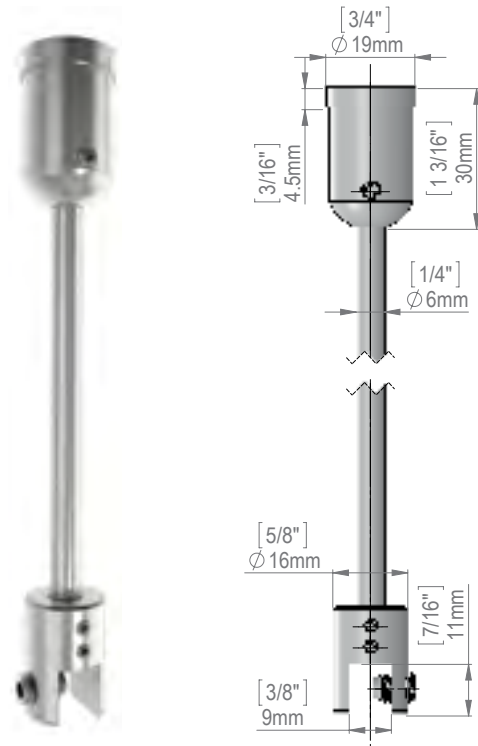



Suspended Rod Kit  
(2 full set)  
SKU: ARG1902-1  
\* Mounting Hardware Included.  
\* Sold without the acrylic.

Length	Aluminum Clear
3'	ARG1902-1
4'11"	ARG1902-2 (Stainless Steel Rod)
6'	ARG1902-3
9'	ARG1902-4

Length	Stainless Steel
3'	SRG1902-1
4'11"	SRG1902-2
6'	SRG1902-3
9'	SRG1902-4

### Accessories

Description	SKU
 Nut and Ceiling Support For Ceiling Rod Suspended Aluminum Kit (Sold without Rod)	ARG1902EP
 Nut Support (Threaded M4) For Ceiling Rod Suspended Aluminum Kit	ARG1902N

## Suspended Rod Kits

### Banner Mounts and Rods



Description	Diameter	Cable Diameter	Aluminum Clear (A)	Stainless Steel Satin Brushed (S)
Rod Cable / Rod Connector	5/8"	1/16"	SR063A	SR063
36" Rod Threaded Each end	1/4"	1/16"	ROD3A	ROD3

## Rod Banner Hanger

- Easy to use design for quick installation every time
- Contemporary styling
- A variety of applications



SKU: SA1600A



SKU: ASA1724

Description	Diameter	Aluminum Clear (A)	Stainless Steel Satin Brushed (SS)
 Rod Ceiling Mount	5/8"	100.363	100.363-R 100.363-SR
 Wall Mount	11/16"	ASA1724	SSA1724
 Rod	1/4"	ROD3A	ROD3
 Junction Part	7/8"	SA1600A	N/A
 36" Pipe	5/8"	PIPE-16A	N/A



## Hooks for Stainless Steel and Nylon Cable



SKU: H103NK

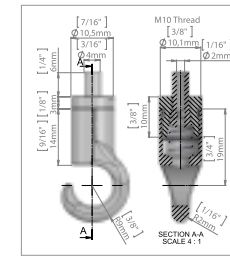

SKU: GH0012

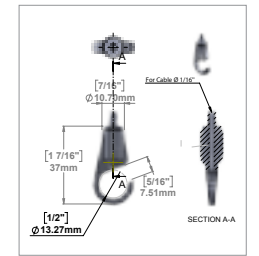

SKU: H104NK

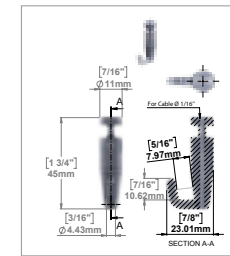

SKU: GH0013

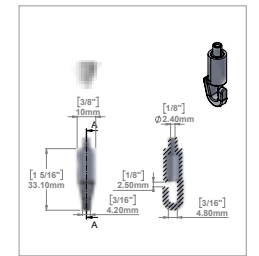

SKU: H105NK

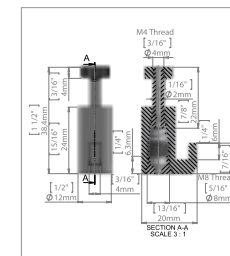

SKU: GH0014

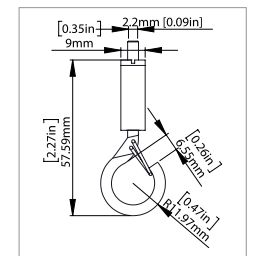

SKU: SGH100

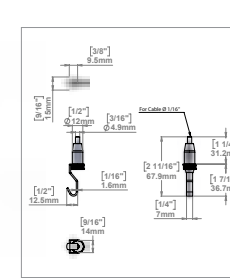

SKU: GH0015

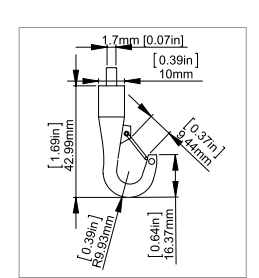

Finish	Use	Diameter	Strength	Use
Nickle	Ball End, Cobra Cable, "P" Hook Cable	3/64" to 1/16"	15 lbs (6kg)	Classic Rail, Ceiling Rail, Easy Rail



## Sign Hangers for Panels & Brackets



### Sooper Sign Hanger

- Bolts through sign
- Clean Finish look



Dimensions	Material Thickness	Stainless Steel Mill	Aluminum White Coated
1" x 3"	1/2"	29511-500	29511-500W
	3/4"	29511-750	29511-750W

## Sign Hangers for Panels & Brackets

### Sooper Center Brackets

- Mount Solid Substrate between post or off wall
- Can use Sooper Center Brackets for added strength
- Aluminum White Powder Coated finish will not rust



Dimensions	Material Thickness	Aluminum White Coated
2" H x 2-5/16" W x 1-1/2" D	1/4"	CBA9025W
2" H x 2-1/2" W x 1-1/2" D	1/2"	CBA9050W
2" H x 2-3/4" W x 1-1/2" D	3/4"	CBA9075W

### Sooper U Brackets

- This U shaped end bracket utilized on a wall, desktop or ceiling is quite versatile
- For use in all sorts of different mounting applications

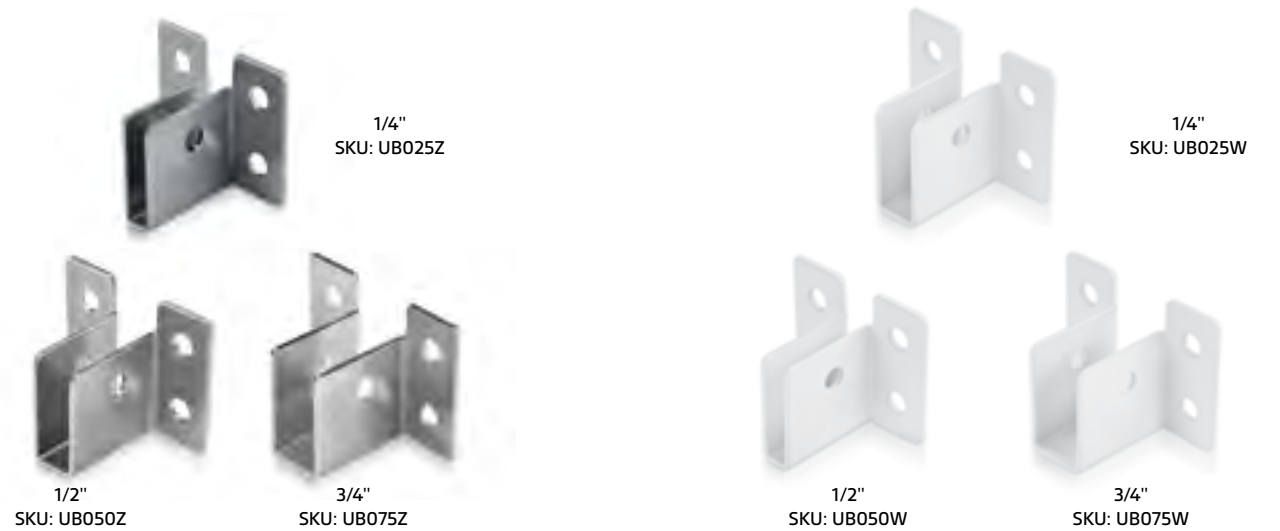

Dimensions	Material Thickness	Steel Zinc Coated	Aluminum White Coated
2" H x 2-5/16" W x 1-9/16" D	1/4"	UB025Z	UB025W
2" H x 2-1/2" W x 1-9/16" D	1/2"	UB050Z	UB050W
2" H x 2-3/4" W x 1-9/16" D	3/4"	UB075Z	UB075W



## Cable / Rod Systems

	<b>Signature Cable Systems</b>	<b>188</b>		<b>Row by Row Attached Cable System</b>	<b>208</b>
	<b>Cable Kits</b>	<b>190</b>		<b>Row Attached Cable System</b>	<b>209</b>
	<b>Rod Kits</b>	<b>195</b>		<b>LED Poster Holder</b>	<b>210</b>
	<b>Panel Grips for Cable Kits</b>	<b>200</b>		<b>1/4\"Rod Sign Holder</b>	<b>212</b>
	<b>Panel Grips for Cable &amp; Rod Kits</b>	<b>202</b>		<b>1/4\"Rod Accessories</b>	<b>214</b>
	<b>Shelf Supports</b>	<b>204</b>		<b>Aluminum Track and Accessories</b>	<b>215</b>
	<b>Accessories</b>	<b>205</b>		<b>Magnetic Pot</b>	<b>215</b>
	<b>Acrylic Sign Holders</b>	<b>206</b>			



## Signature Cable Systems

### 1/16" - 1/8" Diameter Mounted Cable Kits

For Signage, Displays, Posters and Graphics

#### Aluminum Clear Anodized / Matte Black / Chrome Polished

- Aluminum Mounted Kit Includes:
- (2) Arms
- (1) Cable 13' long, diameter 1/16" made from galvanized steel
- (1) Tension adjuster in 1 arm
- (2) Washer stabilizers
- Mounting hardware included

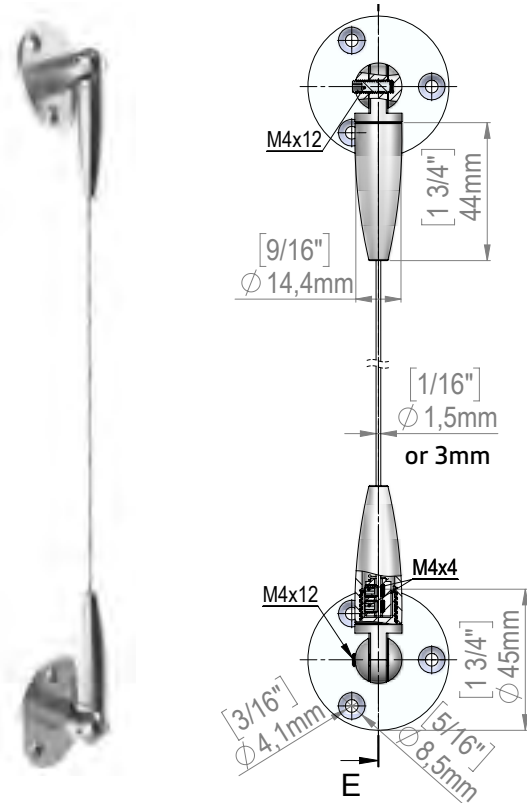

## Signature Cable Systems



Aluminum Clear  
(A)

SKU: SCS15A



Aluminum Matte Black  
(MB)

SKU: SCS15MB



Aluminum Chrome Polished  
(CP)

SKU: SCS15CP



#### Aluminum Clear (A)

#### Aluminum Matte Black (MB)

#### Aluminum Chrome Polished (CP)

Cable Diameter	Cable Length	SKU	Cable Diameter	Cable Length	SKU	Cable Diameter	Cable Length	SKU
1/16"	13'	SCS15A	1/16"	13'	SCS15MB	1/16"	13'	SCS15CP
1/8"	13'	SCS3A	1/8"	13'	SCS3MB	1/8"	13'	SCS3CP

## Sign Hangers for Panels & Brackets

### 1/16" Cable Diameter Multi Angle Cable Kits

Wall to Wall, Ceiling to Floor, Wall to Floor, Wall to Ceiling

#### Aluminum

- Mounted Kit Includes:
- (2) Adjustable mounts
- (1) Cable 13' long, diameter 1/16" made from galvanized steel
- Spring tension adjuster
- Mounting hardware

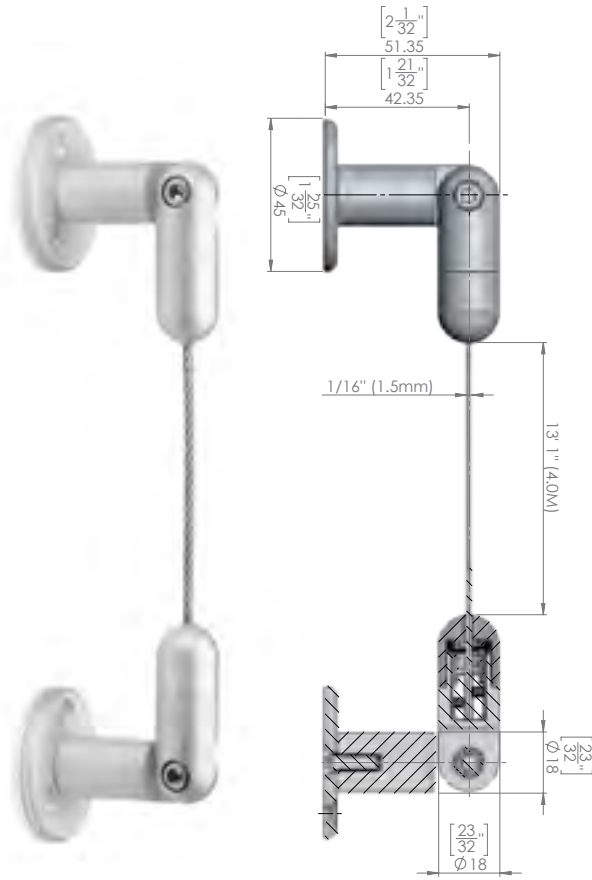

Aluminum Clear

SKU: CS15A

#### Stainless Steel

- Mounted Kit Includes:
- (2) Adjustable mounts
- (1) Cable 13' long, diameter 1/16" made from stainless steel
- Spring tension adjuster
- Mounting hardware

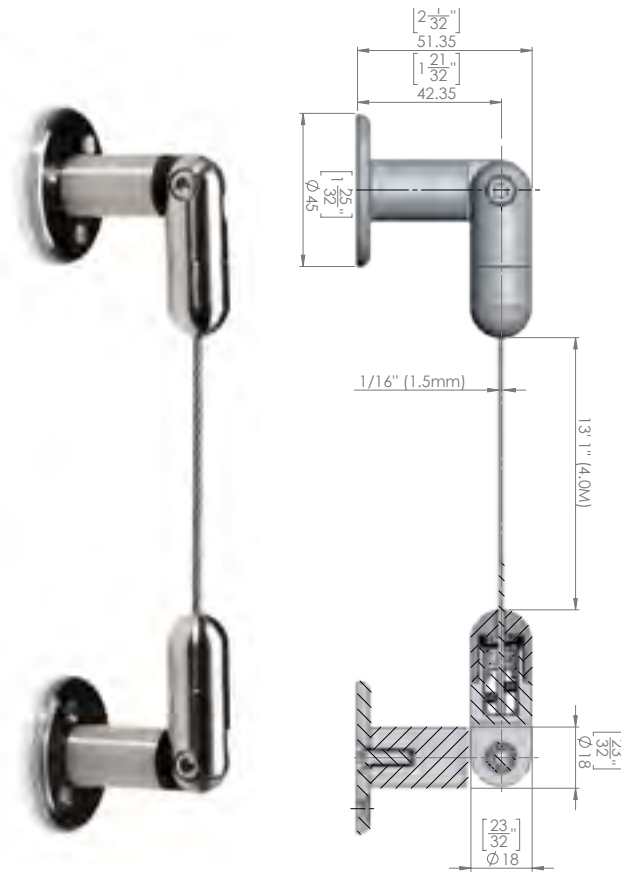

Stainless Steel Satin Brushed

SKU: CS15SS

Adjustable Angle up to 90°



## 1/16" Cable Diameter / Ceiling to Floor Mounted Kits

For Signage, Displays, Posters and Graphics

In this section, each of our cable kits; (aluminum or stainless steel); come with a 1/16" galvanized stainless steel cable. All of our stainless steel cables are composed of 7 strands and each strand consists of 7 wires which in turn gives a total of 49 wires twisted together. Our 1/16" diameter cables have a load capacity of 55 lbs (Approximately 115 kg). Each system kit (ceiling to floor, ceiling/floor to wall, wall to wall, and multifunction) come with a specific cable length but additional cable can be supplied upon request. All of our cable systems must be anchored into a solid material. Most of our cable kits can also be used with our track systems excluding only the multi-function kits.

#### Aluminum

- Ceiling to Floor Mounted Kit Includes:
- (1) Ceiling mount
- (1) Cable 13' long, diameter 1/16" made from galvanized steel
- (1) Tension adjuster / Floor mount
- Mounting hardware included

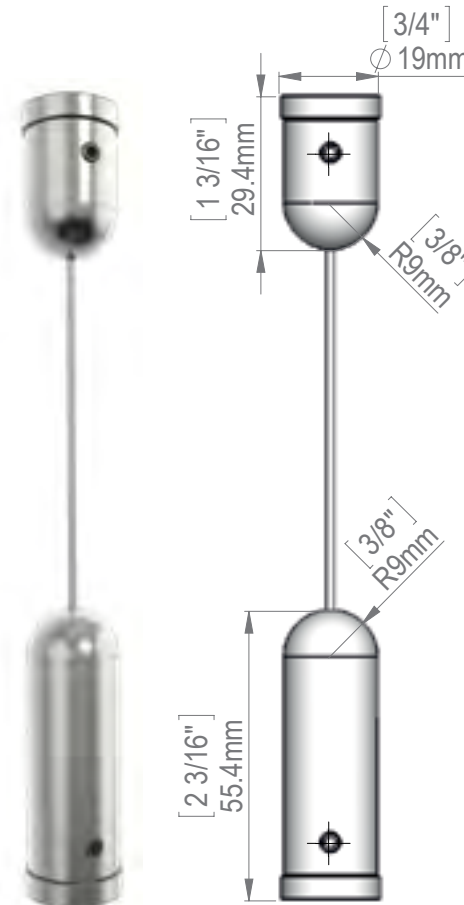

Aluminum Clear (A)

SKU: ACG1904

#### Stainless Steel

- Ceiling to Floor Mounted Kit Includes:
- (1) Ceiling mount
- (1) Cable 16'4" long, diameter 1/16" made from stainless steel
- (1) Tension adjuster / Floor mount
- Mounting hardware not included

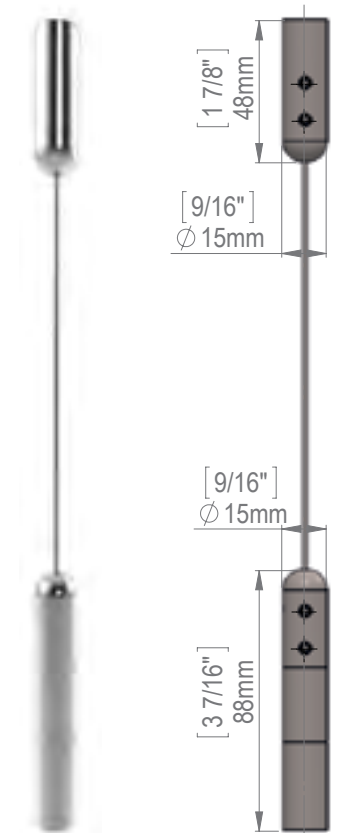

Stainless Steel Satin Brushed

SKU: SCG1904



## 1/16" Cable Diameter / Ceiling to Wall Mounted Kits

For Signage Displays, Posters and Graphics

### Aluminum

Mounted Kit Includes:

- (1) Ceiling mount
- (1) Cable 13' long, diameter 1/16" made from galvanized steel
- (1) Tension adjuster, 1 horizontal arm
- (1) Washer stabilizer
- Mounting hardware included

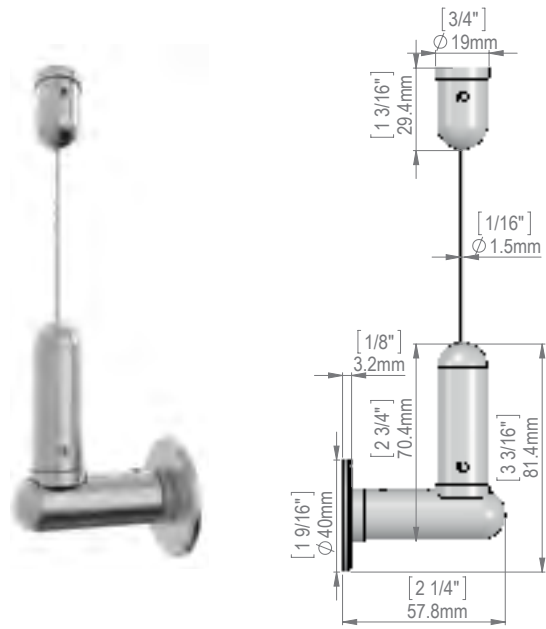

Aluminum Clear

SKU: ACG1907

### Stainless Steel

Mounted Kit Includes:

- (1) Ceiling mount
- (1) Cable 16' 4" long, diameter 1/16" made from stainless steel
- (1) Tension adjuster, 1 horizontal arm
- (1) Washer stabilizer
- Mounting hardware not included

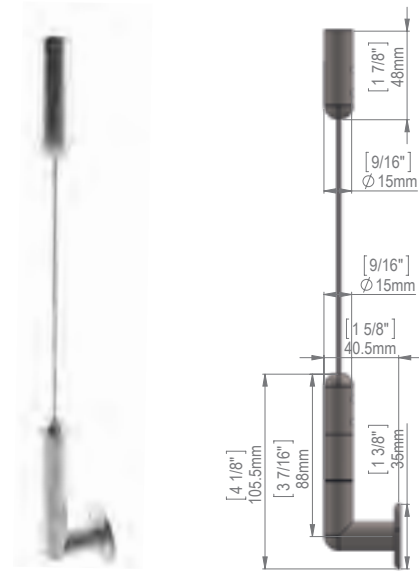

Stainless Steel Satin Brushed

SKU: SCG1905 & SCG1907

## 1/16" Cable Diameter / Wall to Wall Mounted Kits

For Signage Displays, Posters and Graphics

### Aluminum

Mounted Kit Includes:

- (2) Mounts
- (1) Cable 13' long, diameter 1/16" made from galvanized steel
- (1) Tension adjuster, 2 horizontal arms, 1 vertical mount
- (2) Washer stabilizer
- Mounting hardware included

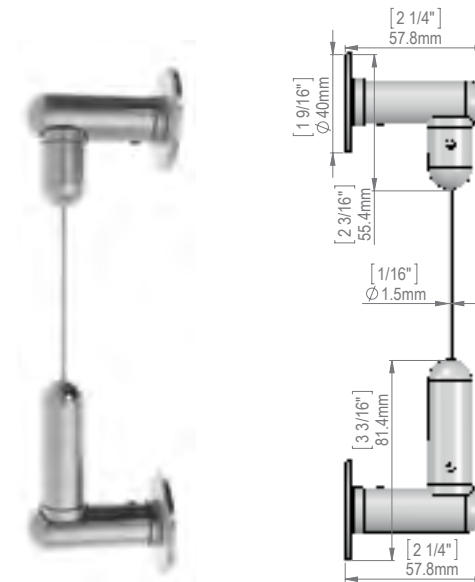

Aluminum Clear

SKU: ACG1908

### Stainless Steel

Mounted Kit Includes:

- (2) Mounts
- (1) Cable 16' 4" long, diameter 1/16" made from stainless steel
- (1) Tension adjuster, 2 horizontal arms, 1 vertical mount
- (2) Washer stabilizer
- Mounting hardware not included

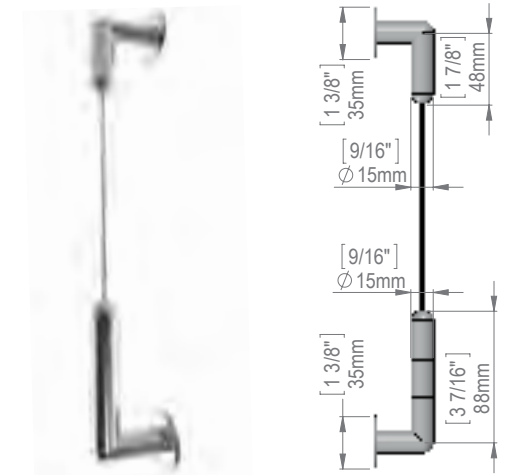

Stainless Steel Satin Brushed

SKU: SCG1908

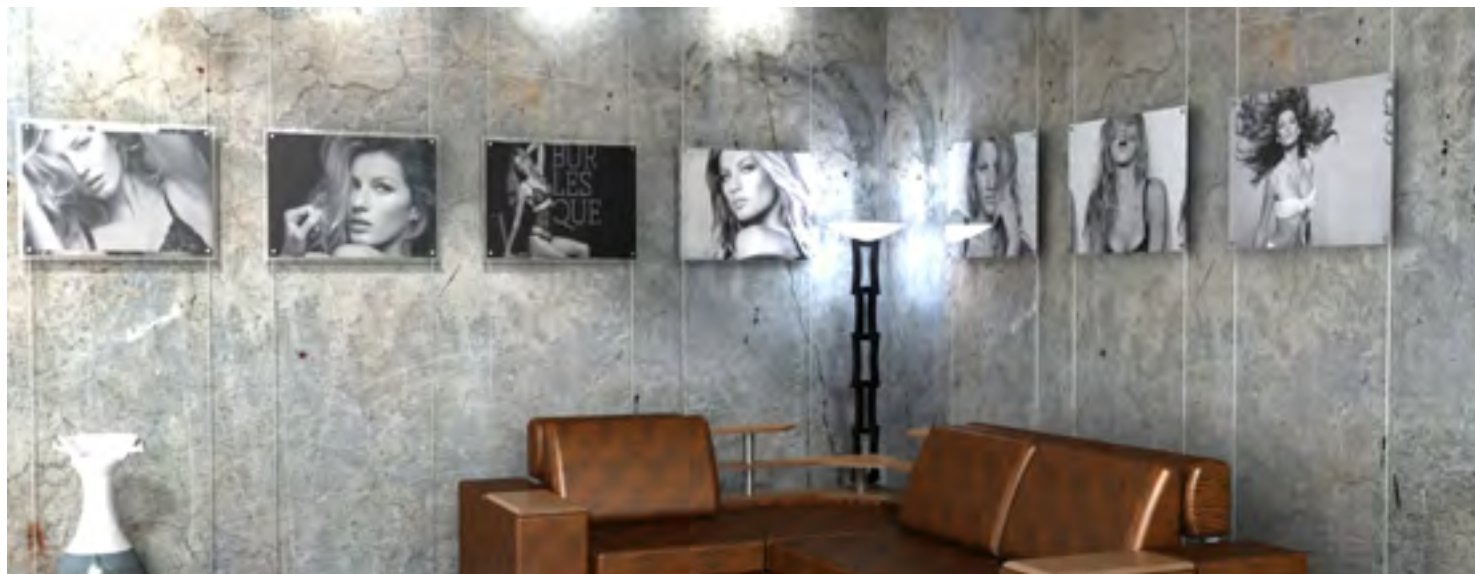





## 1/4" Rod Ceiling to Wall / Wall to Floor Mounted Kits

For Signage, Displays, Posters and Graphics

### Ceiling to Wall

- Mounted Kit Includes:
- (1) Ceiling / Wall mount
- (1) Rod
- (1) Tension adjuster
- (1) Horizontal arm
- (1) Washer stabilizer
- ARG1905 sold without rod
- Mounting hardware included

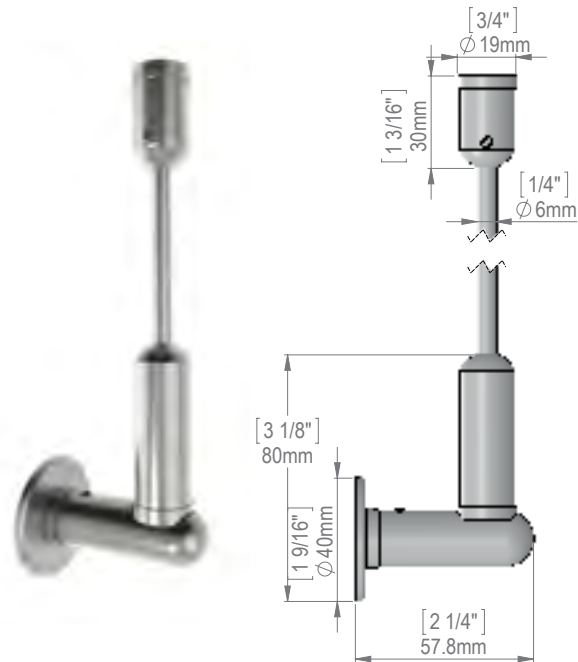

Length	Aluminum Clear	Stainless Steel Satin Brushed
3'	ARG1905-1	SRG1905-1
4' 11"	ARG1905-2 (Stainless Steel Rod)	SRG1905-2
6'	ARG1905-3	SRG1905-3
9'	ARG1905-4	SRG1905-4

### Wall to Floor

- Mounted Kit Includes:
- (1) Wall / Floor mount
- (1) Rod
- (1) Tension adjuster
- (1) Horizontal arm
- (1) Washer stabilizer
- SRG1906 sold without rod
- Mounting hardware not included

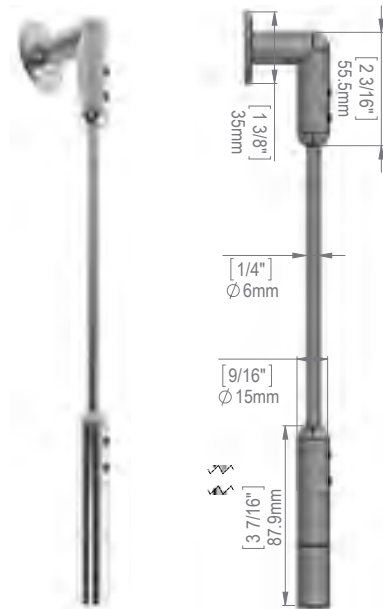

Length	Aluminum Clear	Stainless Steel Satin Brushed
3'	ARG1906-1	SRG1906-1
4' 11"	ARG1906-2 (Stainless Steel Rod)	SRG1906-2
6'	ARG1906-3	SRG1906-3
9'	ARG1906-4	SRG1906-4

## 1/4" Rod Wall to Wall Mounted Kits

For Signage, Displays, Posters and Graphics

### Aluminum

- Mounted Kit Includes:
- (2) Washer stabilizers
- (2) Horizontal arms
- (1) Ceiling mount
- (1) Floor
- (1) Rod
- (1) Tension adjuster
- ARG1907 sold without rod
- Mounting hardware included

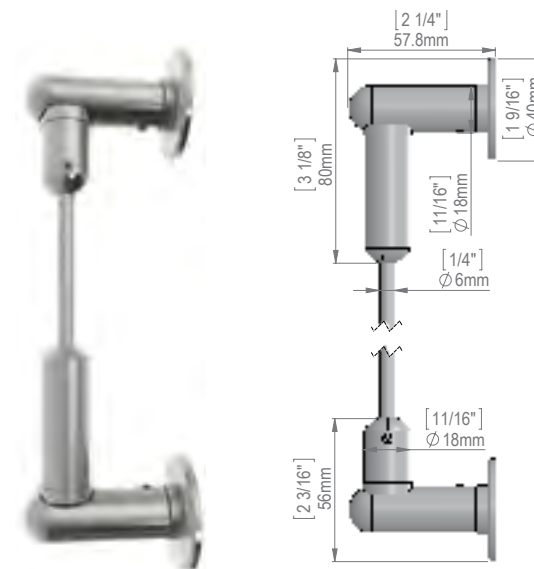

Length	Aluminum Clear
3'	ARG1907-1
4' 11"	ARG1907-2 (Stainless Steel Rod)
6'	ARG1907-3
9'	ARG1907-4

### Stainless Steel

- Mounted Kit Includes:
- (2) Washer stabilizers
- (2) Horizontal arms
- (1) Ceiling mount
- (1) Floor
- (1) Rod
- (1) Tension adjuster
- SRG1907 sold without rod
- Mounting hardware not included

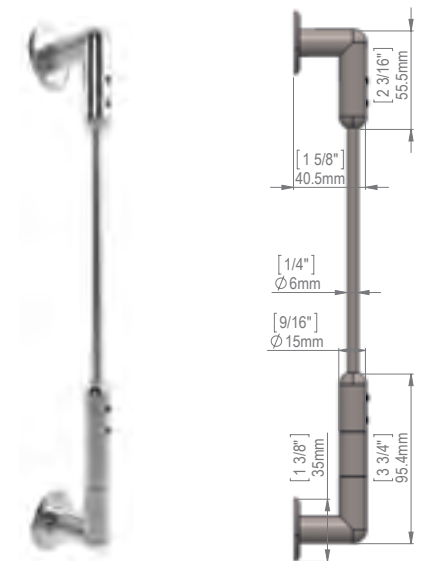

Length	Stainless Steel Satin Brushed
3'	SRG1907-1
4' 11"	SRG1906-2
6'	SRG1907-3
9'	SRG1907-4



### 3/8" Rod Ceiling to Floor / Wall to Ceiling Mounted Kits

For Signage, Displays, Poster and Graphics

Aluminum Clear Anodized or Matte Black

#### Ceiling to Floor Mounted Kit Includes:

- (1) Ceiling mount
- (1) Floor mount
- (1) Rod
- (1) Tension adjuster
- Mounting hardware included
- ARG3904A and ARG3904B sold without rod

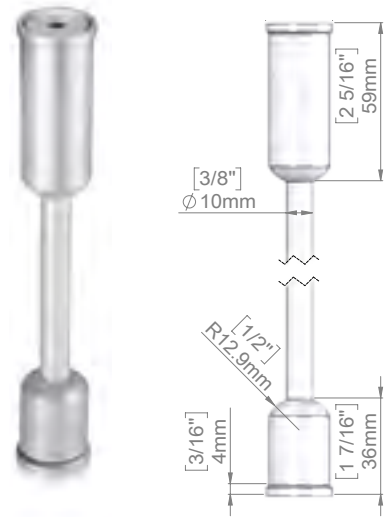

#### Wall to Ceiling Mounted Kit Includes:

- (1) Ceiling mount
- (1) Rod
- (1) Horizontal arm
- (1) Washer stabilizer
- Mounting hardware not included
- ARG3910A and ARG3910B sold without rod

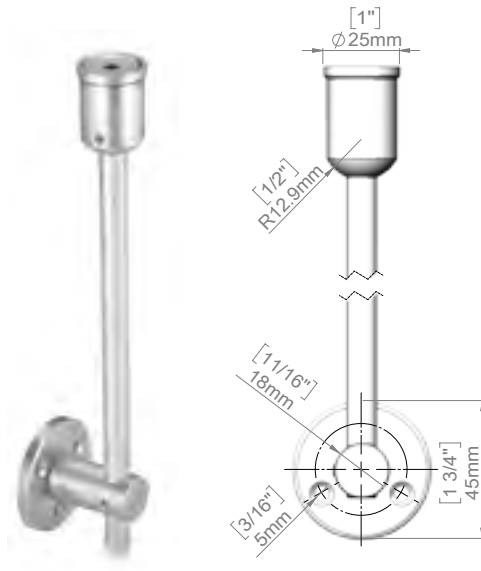

Length	Aluminum Clear (A)	Aluminum Matte Black (B)
3'	ARG3904A-1	ARG3904B-1
6'	ARG3904A-2	ARG3904B-2
9'	ARG3904A-3	ARG3904B-3

Length	Aluminum Clear (A)	Aluminum Matte Black (B)
3'	ARG3910A-1	ARG3910B-1
6'	ARG3910A-2	ARG3910B-2
9'	ARG3910A-3	ARG3910B-3

### 3/8" Rod to Wall Mounted Kits

For Signage, Displays, Poster and Graphics

Aluminum Clear Anodized or Matte Black

#### Mounted Kit includes:

- (2) Horizontal arms
- (1) Rod
- (2) Washer stabilizers
- Mounting hardware not included
- ARG3909A and ARG3909B sold without rod

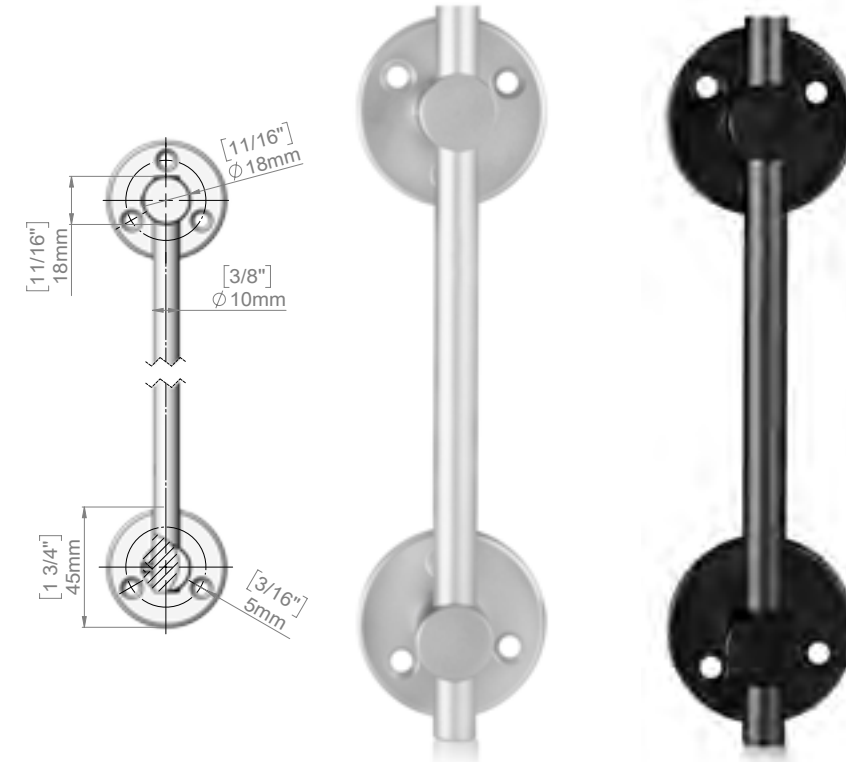

Length	Aluminum Clear (A)	Aluminum Matte Black (B)
3'	ARG3909A-1	ARG3909B-1
6'	ARG3909A-2	ARG3909B-2
9'	ARG3909A-3	ARG3909B-3





## Panel Grips Diameter Cable Kits

For Signage, Displays, Poster and Graphics

Technical Information	Material Thickness Accepted	Gap from Cable	1/16" Cable		1/8" Cable			
			Aluminum Clear	Stainless Steel	Aluminum Clear	Stainless Steel		
<b>Vertical Support</b>								
		Single Sided	1/16" to 3/16"	1/8"	ACA1016	SCA1016	N/A	N/A
		Double Sided	1/16" to 3/16"	1/8" x 2	ACA1023	SCA1023	N/A	N/A
		Single Sided	1/8" to 3/8"	3/16"	ACA1610	SCA1610	ACA31610	SCA31610
		Double Sided	1/8" to 3/8"	3/16" x 2	ACA1612	SCA1612	ACA31612	SCA31612
		Single Sided Top edge	1/8" to 3/8"	N/A	ACA1660	SCA1660	ACA31660	SCA31660
<b>Pivoting Support</b>								
		Single Sided	1/8" to 5/16"	1/2"	ACA1620	SCA1620	ACA31620	SCA31620
		Double Sided	1/8" to 5/16"	1/2" x 2	ACA1622	SCA1622	ACA31622	SCA31622
		Double Sided	3/16" to 1/2"	1/2" x 2	N/A	SCA1812	N/A	N/A
		Single Sided	1/8" to 1/2"	1/2"	ACA2010	SCA2010	ACA32010	SCA32010
		Double Sided	1/8" to 1/2"	1/2" x 2	ACA2012	SCA2012	ACA32012	SCA32012

## Panel Grips Diameter Cable Kits

For Signage, Displays, Poster and Graphics

1/4" Rod		3/8" Rod	
Aluminum Clear	Stainless Steel	Aluminum Clear	Aluminum Matte Black
N/A	N/A	ARA3610A	ARA3610B
N/A	N/A	ARA3612A	ARA3612B
ARA1610	SRA1610	N/A	N/A
ARA1612	SRA1612	N/A	N/A
N/A	N/A	N/A	N/A
ARA1620	SRA1620	ARA3620A	ARA3620B
ARA1622	SRA1622	ARA3622A	ARA3622B
N/A	N/A	N/A	N/A
ARA2010	SRA2010	ARA3810A	ARA3810B
ARA2012	SRA2012	ARA3812A	ARA3812B

Technical Information

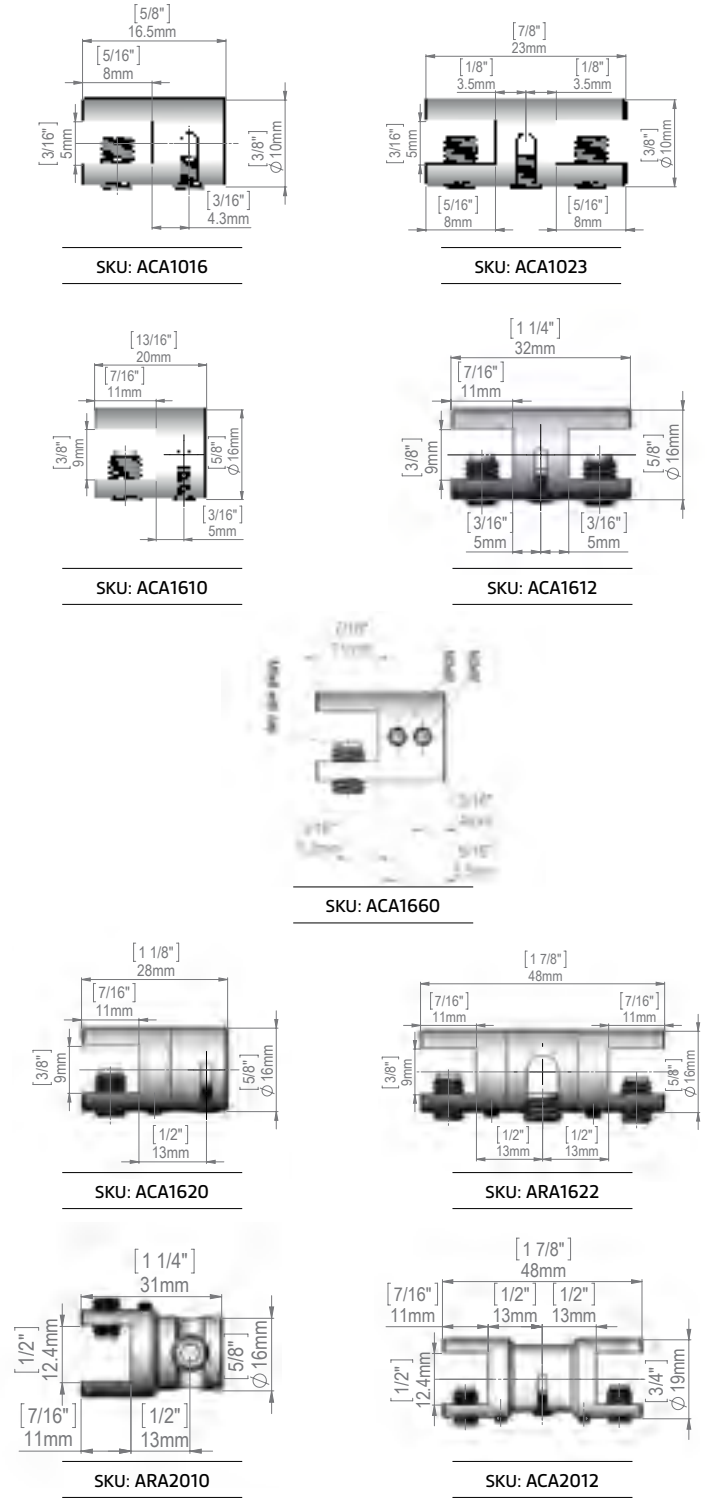

## Panel Grips For Cable & Rod

For Signage, Displays, Poster and Graphics

Technical Information			Material Thickness Accepted	Gap from Cable	Hole Material
<b>Panel Support Standoffs</b>					
			Single Sided	1/16" to 5/16"	3/16" 1/4"
			Double Sided	1/16" to 5/16"	3/16" x 2 1/4"
<b>Edge Support</b>					
			Single Sided	1/16" to 3/8"	3/16" N/A
			Top Edge	1/8" to 3/8"	N/A N/A
<b>Pivoting Edge Support</b>					
			Single Sided	1/16" to 3/8"	1/2" N/A
			Double Sided	1/16" to 3/8"	1/2" x 2 N/A
<b>Horizontal Support</b>					
			Single Sided	1/16" to 5/16"	3/16" N/A
			Double Sided	1/16" to 5/16"	3/16" x 2 N/A



Extended Stainless Steel M5 Threaded Head for 1/2" Material  
Used with SCA1640, SCA1642, SRA1640, SRA1642

SKU: SRA1640-H12

## Panel Grips For Cable & Rod

For Signage, Displays, Poster and Graphics

1/16" Cable		1/8" Cable		1/4" Rod		3/8" Rod	
Aluminum Clear	Stainless Steel	Aluminum Clear	Stainless Steel	Aluminum Clear	Stainless Steel	Aluminum Clear	Aluminum Matte Black
ACA1640	SCA1640	ACA31640	SCA31640	ARA1640	SRA1640	ARA3640A	ARA3640B
SCA1631	SCA1642	ACA31642	SCA31642	ARA1642	SRA1642	ARA3642A	ARA3642B
ACA1630	SCA1630	ACA31630	SCA31630	N/A	N/A	N/A	N/A
ACA1660	SCA1660	ACA31660	SCA31660	ARA1660	SRA1660	N/A	N/A
ACA1631	SCA1631	ACA31631	SCA31631	ARA1631	SRA1631	ARA3631A	ARA3631B
ACA1632	SCA1632	ACA31632	SCA31632	ARA1632	SRA1632	ARA3632A	ARA3632B
ACB1610	SCB1610	ACB31610	SCB31610	ARB1610	SRB1610	ARB3610A	ARB3610B
ACB1612	SCB1612	ACB31612	SCB31612	ARB1612	SRB1612	ARB3612A	ARB3612B

Technical Information

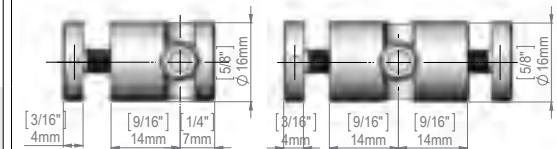

SKU: ARA1640

SKU: ARA1642

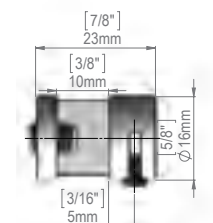

SKU: ACA1630

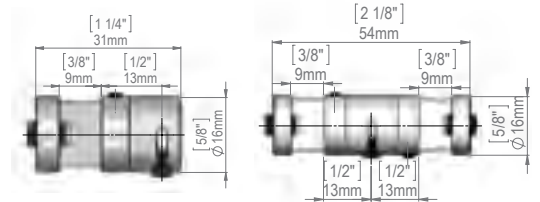

SKU: ACA1631

SKU: ACA1632

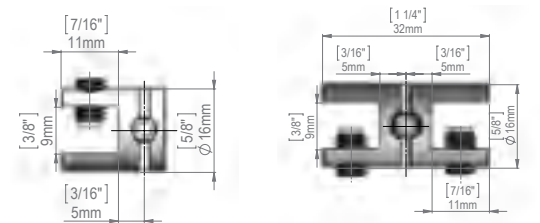







SKU: ACB1610

SKU: ACB1612

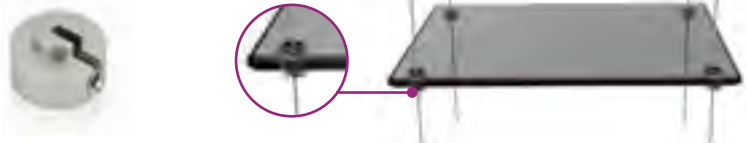
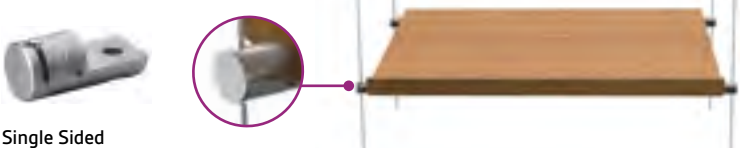

## Shelf Supports

### Sign Holders for Inserts

Technical Information	Material Thickness Accepted	Gap from Cable	Mounting Diameter	Cable 1/16"		
				Aluminum Clear	Stainless Steel	
<b>Shelf Support</b> 	1/8"	N/A	5/16"	ACA1650	SCA1650	
<b>Pivoting Shelf Support</b> 	1/4" to 3/4"	1/2"	N/A	ACA1651	SCA1651	
<b>Single Sided</b> 	1/4" to 3/4"	1/2" x 2	N/A	ACA1652	SCA1652	
<b>Double Sided</b> 	1/8" to 3/8"	N/A	1/4"	ACA1653	SCA1653	
<b>Retainer Screw</b> 	1/8" to 3/8"	N/A	1/4"	ACA1653	SCA1653	
<b>Single Sided</b> 	1/8" to 3/8"	N/A	1/4"	ACA1653	SCA1653	
<b>Tempered Glass</b> 	Size	10" x 24"	10" x 36"	12" x 12"	12" x 24"	12" x 36"
3/16" Thick	SKU	TG10-24	TG10-36	TG12-12	TG12-24	TG12-36

### Accessories

Technical Information	Diameter	Rod 1/4"			Rod 3/8"		
		Aluminum Clear (A)	Aluminum Matte Black (B)	Stainless Steel (SS)	Aluminum Clear (A)	Aluminum Matte Black (B)	Stainless Steel (SS)
<b>Rod</b>							
36" Rod, Threaded and Tapped		ROD3A	N/A	ROD3			N/A
4' 1" Rod, Threaded and Tapped		N/A	N/A	SRG1900-2	N/A	N/A	N/A
End Rod, Male/Female Threaded and Tapped	1/4"	ROD3-EA	N/A	ROD3-ESS	ROD310-EA	ROD310-EB	N/A
Rod Ball end Finish		ARA1630	N/A	N/A	ROD310-REA	ROD310-REMB	ROD310-RESS
<b>Pivoting Standoffs for Rod</b>							
Pivoting Standoff for Rod (Vertically or Horizontally Mount)	5/8"	ASA1724	N/A	SSA1724	N/A	N/A	N/A
Pivoting Standoff for Rod (Vertically or Horizontally Mount)		ASA1750A	ASA1750B	SSA1750S	N/A	N/A	N/A

\*For cable, pivoting support check item: CS3CTA, CS3CTB

## Shelf Supports

### Sign Holders for Inserts

Cable 1/18"		Rod 1/4"		Rod 3/8"	
Aluminum Clear	Stainless Steel	Aluminum Clear	Stainless Steel	Aluminum Clear	Stainless Steel
N/A	SCA31650	ARA1650	SRA1650	ARA3650A	ARA3650B
ACA31651	SCA31651	ARA1651	SRA1651	ARA3651A	ARA3651B
ACA31652	SCA31652	ARA1652	SRA1652	ARA3652A	ARA3652B
ACA31653	N/A	N/A	N/A	N/A	N/A
N/A	N/A	N/A	N/A	N/A	N/A
N/A	N/A	N/A	N/A	N/A	N/A

### Technical Information

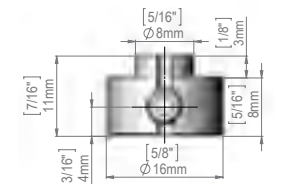

SKU: SCA1650

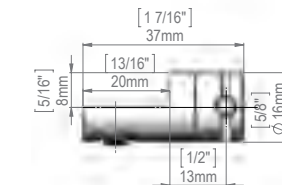

SKU: SCA1651

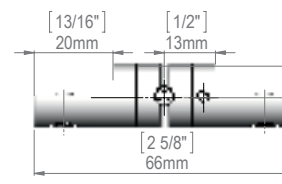

SKU: SCA1652

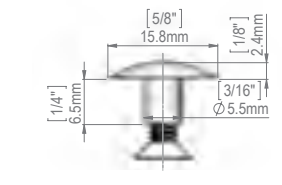

SKU: SCA1653

### For 3/8" Rods



**End Rod Matte Black**  
SKU: ROD310-EB



**Ceiling Suspended Kit**  
M6 Reverse Thread Clear or Matte Black  
SKU: ARG3902A

### For 1/4" Rods



**End Rod**  
SKU: ROD3-EA

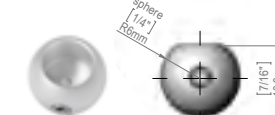

**Rod Ball End Finish**  
SKU: ARA1630



**Pivoting Standoffs for Rod**  
SKU: ASA1724

### Aluminum Clear Anodized Rod

SKU: ROD3A



## Acrylic Sign Holders

### Sign Holders for Inserts



This acrylic sign holder is ideal for displaying marketing materials. The 8.5" x 11" or 11" x 17" top insert frames allow users to quickly and easily switch out signage selections. This sign holder that hangs in a cable system, also known as acrylic literature frame, is an exciting way to create signage in any environment. Purchasers can use one of these literature frames or create a full display by using multiple acrylic panels! This sign holder is made of crystal clear acrylic and the frames are in stock, for you to purchase today.

This fold-over sign holder can be mounted onto the cable system virtually anywhere to maximize viewing. These acrylic frames are ideal for use in retail stores, restaurants, and more! This sign holder that holds 8.5" x 11" or 11" x 17" graphics is affordable and convenient! Panels for signage in both portrait + landscape are available in both sizes. Our acrylic sign holders are an impressive way to showcase 8.5" x 11" or 11" x 17" graphics when combined with our cable hanging kits.

### Cable & Rod Systems

These systems are extremely versatile and create amazingly subtle displays that can be integrated into any environment. With so many applications including suspending, shelving, signage, decorative displays, showcase displays and graphic displays.



## Acrylic Sign Holders

### Sign Holders for Inserts

#### 8.5" x 11" Acrylic Sign Holder

- Portrait letter size holder
- 1 Clear acrylic holder for letter sizes 8.5" x 11"
- With 2 magnets on the top to keep acrylic closed
- Acrylic only, hardware not included

SKU: ACB8511

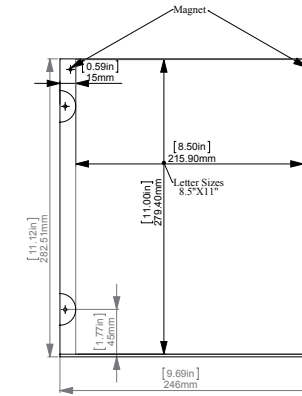

#### 11" x 8.5" Acrylic Sign Holder

- Landscape letter size holder
- 1 Clear acrylic holder for letter sizes 11" x 8.5"
- With 2 magnets on the top to keep acrylic closed
- Acrylic only, hardware not included

SKU: AC1185

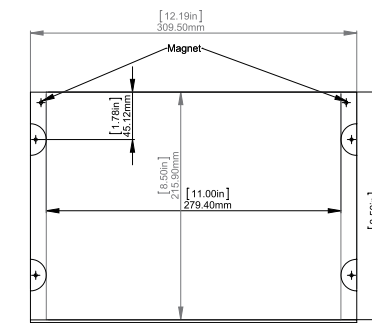

#### 11" x 17" Acrylic Sign Holder

- Portrait ledger size Holder
- 1 Clear acrylic holder for letter sizes 11" x 17"
- With 2 magnets on the top to keep acrylic closed
- Acrylic only, hardware not included

SKU: AC1117

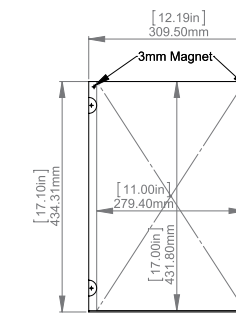

#### 17" x 11" Acrylic Sign Holder

- Landscape ledger size holder
- 1 Clear acrylic holder for letter sizes 17" x 11"
- With 2 magnets on the top to keep acrylic closed
- Acrylic only, hardware not included

SKU: AC1711

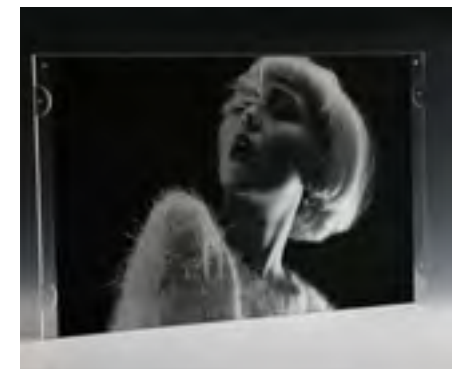
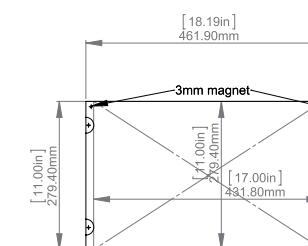



### Row by Row Attached Cable System

#### Sign Holders for Inserts

- 64 Different layouts
- 4 Different Finishes
- 2 Different materials
- Portrait / Landscape
- 3 Different installation types
- 3 Different styles



"Full kits will include cable systems, panel supports, acrylic panels, and mounting hardware"

### Row Attached Cable System

#### Sign Holders for Inserts

- 64 Different layouts
- 4 Different Finishes
- 2 Different materials
- Portrait / Landscape
- 3 Different installation types
- 3 Different styles



"Full kits will include cable systems, panel supports, acrylic panels, and mounting hardware"





## LED Poster Holder

Acrylic LED Sign Holder Kits

- Ultra-Bright LED Panel
- Ultra-Slim LED Panel
- No need to change tubes or lamps!
- No visible power supply
- Maintenance Free!

**Power Connector For LED Poster Holder**  
SKU: ACA1212



## LED Light Boxes

The ultra-bright LED panel floats like magic with no visible power supply, drawing people to look at your promotional material. The acrylic display holder is suspended from almost invisible powered cables which are fitted on the wall in on our innovative LED Cable Display Systems.

Position the acrylic signs in the window or interior of your premises to make stunning window displays, or use the double sided units to create eye catching partitions within your premises. Transform the appearance of your premises with these ultra slim LED light boxes that are only 3/16" (9 mm) thick. The acrylic LED light box looks different from anything else on the market!

\* Acrylic is not recommended for engraving purposes

Description	SKU
LED Poster Holder Kit 1. Single Sided LED Light Pocket Letter Size	KLP1
LED Poster Holder Kit 2. Single Sided LED Light Pocket Letter Size	KLP2
LED Poster Holder Kit 3. Single Sided LED Light Pocket Letter Size	KLP3
LED Poster Holder Kit 4. Single Sided LED Light Pocket Letter Size	KLP4



## LED Poster Holder

Acrylic LED Sign Holder Kits



Provide an eye catching way to illuminate your posters and photographs that add sparkle and interest drawing attention to your promotional messages.

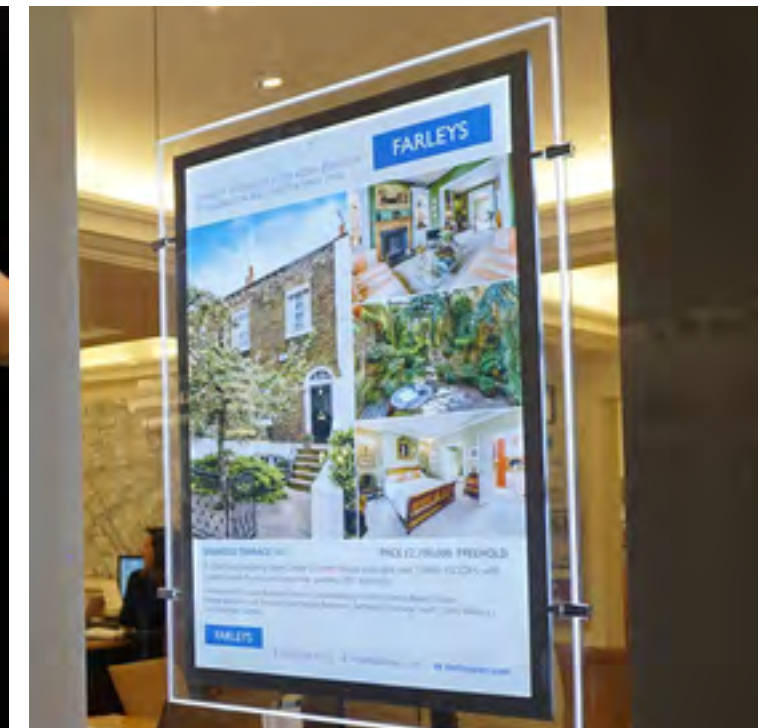



## 1/4" Rod Sign Holder



### Sign Holder

- Our cleverly designed rod display system is perfect for any application.
- Our supports can be placed any distance apart making it versatile to any size sign needing to be displayed.
- These rod display systems use the same techniques as the cable system, only using stainless steel or aluminum rods instead.
- Highly recommended for heavy duty hanging.
- Rods can be easily fastened together for any length desired.
- Rod ends can be finished with a nifty aluminum "ball" or end cap to provide the perfect professional image.
- Use with ASA1724, SSA1724 or (pivoting standoff support), ROD3, ROD3A (1/4" diameter, 3' length rod), and our pivoting supports.
- The rod system is now in stock and available for next day delivery.



## 1/4" Rod Sign Holder

### Acrylic Sign Holder

- Acrylic sign holders are used for displaying manuals, magazines, literature, greeting cards, flyer and more.
- Our high quality acrylic sign holders are made of acrylic material for long lasting durability.
- Features an impact resistant design for superior performance.
- Accepts media 8.5" x 11" or under vertically.
- Use with ASA1724 (pivoting standoff support) and our ROD3, ROD3A (1/4" diameter, 3' length rod)



### 8.5" x 11" Clear Acrylic Sign Holder

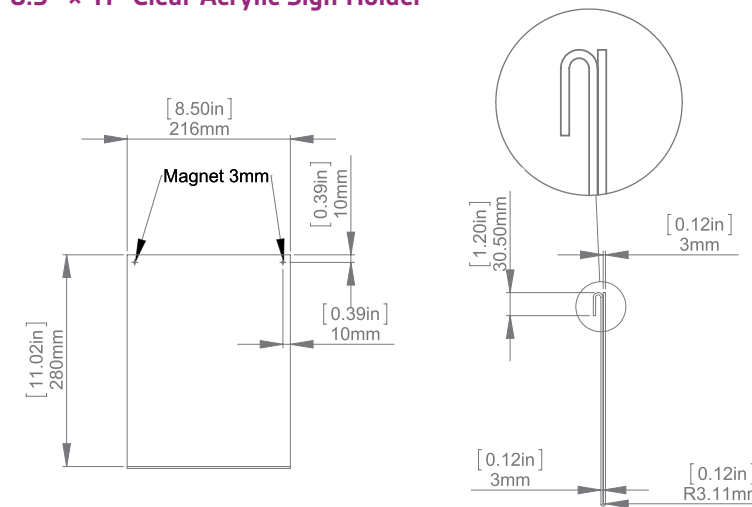

### Vertical Letter Size Holder:

- 1 Clear acrylic holder for letter sizes 8.5" x 11"
- With 2 magnets on the top to keep acrylic closed
- Acrylic only, hardware not included

Acrylic Sign Holder	SKU: RAC8511
---------------------	--------------

Description	Finish	Material	Diameter	Length	SKU
Rod Ceiling Mount	Satin Brushed	Stainless Steel	5/8"	1-7/8"	100.363-SR
Rod Tension Adjuster	Satin Brushed	Stainless Steel	9/16"	3-7/16"	100.362-R
Vertical Assembly Arm	Satin Brushed	Stainless Steel	9/16"	1-1/2"	100.364
Washer Stabilizer	Satin Brushed	Stainless Steel	1-3/8"	3/32"	100.365
Stainless Steel Wall Mount	Satin Brushed	Stainless Steel	5/8"	1-1/4"	SSA1724
Aluminum Wall Mount	Clear Anodized	Aluminum	5/8"	1-1/4"	ASA1724
Aluminum Wall Mount	Clear Anodized	Aluminum	5/8"	2"	ASA1750A
Stainless Steel Rod	Satin Brushed	Stainless Steel	1/4"	36"	ROD3
Aluminum Rod	Clear Anodized	Aluminum	1/4"	36"	ROD3A

## 1/4" Rod Accessories

### 36" Rod

- 1/4" diameter thread and tapped M4
- Indoor use only
- ROD can be threaded together for longer lengths, use ROD3-E to close ends
- Can be cut, use ARA1630 to finish ends.
- Not threaded through

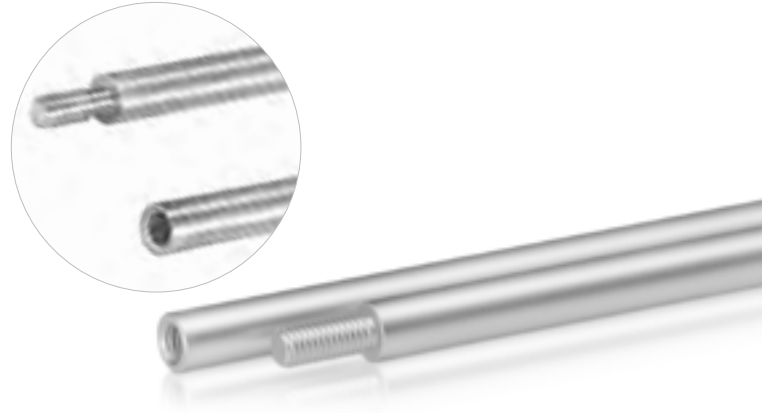

Aluminum Clear Anodized	Stainless Steel SS201
SKU: ROD3A	SKU: ROD3

### End Rod

- Male | Female
- 1/4" diameter thread and tapped M4
- Indoor use only

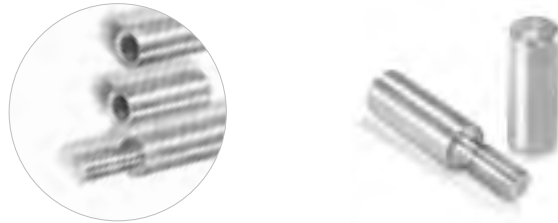

Aluminum Clear Anodized	Stainless Steel SS201
SKU: ROD3-ESS	SKU: ROD3-EA

### Rod

- Stainless steel rod satin finish 1/4" diameter
- SRG1900-2 L: 4'11"



Stainless Steel
SKU: SRG1900-2

### Rod Ball End Finish

- Diameter: 1/2"
- Rod finish ball for rod diameter: 1/4"

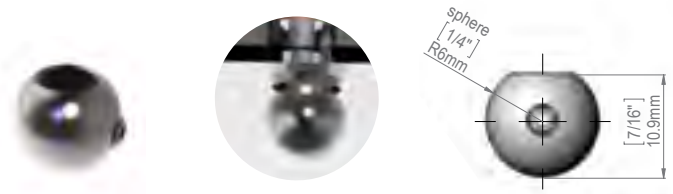

Aluminum Clear Anodized
SKU: ARA1630

### Pivoting Standoff for Rod

- Diameter: 5/8"
- Pivoting standoff for rod diameter: 1/4"
- Standoff: 1" or 1-3/4" available



Aluminum Clear Anodized	Stainless Steel
SKU: ASA1724	SKU: ASA1750
	SKU: SSA1724

## Aluminum Track and Accessories

### Cable/Rod Aluminum Arm

- Arm Diameter: 9/16"
- Washer Diameter: 1-1/2"

Aluminum Clear Anodized Arm	Aluminum Washer
SKU: CRAA	SKU: CRWA



### Aluminum Track

- Aluminum track fixing for mobility
- Clear anodized finished
- Length: 6' (72")

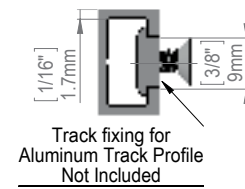

Track fixing for Aluminum Track Profile Not Included



Aluminum Track
SKU: AT1911

### Track Fixing

- Track fixing for aluminum track profile



Parallelogram Track Fixing
SKU: ACW4001



Rectangular Track Fixing
SKU: ACW4002



## Magnetic Pot for Suspended Ceiling

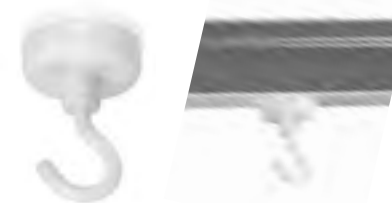

Description	SKU
3/4" Pot Magnet with Hook white painted (Inside use only)	HM20W



Description	SKU
3/4" Pot Magnet (Inside use only) Threaded M4 designed for "ROD3"	MR20NI





# Classic Rail

Page 222

## Art Hanging Systems



<b>Hanging System</b>	<b>218</b>
-----------------------	------------



<b>Easy Rail</b>	<b>220</b>
------------------	------------

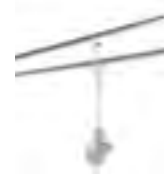

<b>Classic Rail</b>	<b>224</b>
---------------------	------------



<b>Ceiling Rail</b>	<b>228</b>
---------------------	------------



<b>Hanging Cables</b>	<b>232</b>
-----------------------	------------



<b>Hooks for Stainless Steel and Nylon Cable</b>	<b>233</b>
--	------------

**NEW**  
Products Added



<b>Aircraft Wire Cable Stop Clamp Adjuster Gripper Loopers</b>	<b>234</b>
--	------------



<b>Hooks For Stainless Steel and Nylon Cable</b>	<b>234</b>
--	------------



<b>Aluminum Snap Frames</b>	<b>238</b>
-----------------------------	------------



<b>Hanging Banner Rails</b>	<b>239</b>
-----------------------------	------------

## Hanging Systems

For Signage, Displays, Poster and Graphics



## Hanging Systems

For Signage, Displays, Poster and Graphics



### Easy Rail System

Our Easy Rail System is simple, discreet, and designed to use in the home, office, or anywhere that appearance is important.

The key to this beautiful and strong system, rated to withstand loads up to 78 lbs (35 kg), is a series of high strength clips that install behind the rail and out of view. Thanks to the modular nature of the Easy Rail System, you can add to, remove from, or modify your display at any time in just seconds – and no more holes in the wall!



### Classic Rail System

Our Classic Rail System is effortless and inconspicuously designed, with a focus on strength, rated to hold up to an astonishing 300 lbs (136 kg) per rail!

The Classic Rail System is designed with galleries in mind, where a display may be changed many times per week. All of our Hanging Cables and Rods hook on and off in one simple motion to make it easier than ever for you to quickly update your displays!



### Ceiling Rail System

Our Ceiling Rail System installs into the ceiling instead of the traditional wall mounted application.

Mount it open-faced to make changing your display easier than ever or turn it around for a closed-face installation that makes your Art Hanging System even more subtle than before.

Use it in the window of your shop or use it a few inches off of the wall to give your art an amazing floating effect!



## Easy Rail

### Wall-Mounted



#### Modern Design and Discreet! Easy to install!

The Easy Rail is secured to the wall using fastening clips that conceal all fittings and wall anchors.

The Easy Rail picture hanging system is compatible with a wide variety of our hangers and hooks that make horizontal and vertical adjustments carry, effortless and without damage to walls. Nails and unwanted holes will be a thing of the past when using Easy Rail.

#### Installation

The Easy Rail mounts to the walls with the use of Screws and Anchors.

1. To hang items using the Easy Rail, you must select your hanger preference:

- Cobra Cable
- Ball-End Cable

2. After you have selected your hanger option you must then select your hook preference:

- Cable Hook for Stainless Steel and Nylon Cable
- Spring Hook for Nylon Cable

#### Hanger Compatibility

- Cobra Cable – Nylon / 13 lbs
- Cobra Cable – Stainless Steel / 26 lbs
- Ball-End Cable Stainless Steel / 45 lbs

Application: Wall-Mounted

Material: Aluminum

Available Length: 72"

Rail Height: 1"

Available Colors: Silver Satin Anodized, Black Satin

Anodized, White Painted & 180 Colors Powder

Coated \* Special order

Rated Rail Weight: 75 lb / 35 kg

(When properly installed)



## Easy Rail

### Wall-Mounted

#### Finishes



Aluminum Clear

SKU: AT100-A



Aluminum Black

SKU: AT100-B



Aluminum White Painted

SKU: AT100-W

Rail	SKU
Silver Satin Anodized	AT100-A
Black Satin Anodized	AT100-B
White Painted	AT100-W
180 Colors Finishes *	AT100-C
Natural Mill **	AT100-MF

\* RAL standard colors with fee  
\*\* Can have manufacturing scratches

Easy Rails are Picture Hanging Systems that are optimized for home, office or anywhere else. In order to put your system together you will need to choose your finish options, then your hanger options and finally your hook style. Once you have the core of your system selected, you can pick accessories or installation hardware.

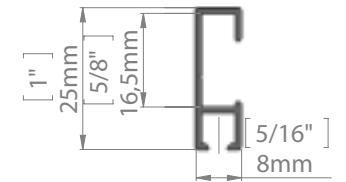

#### Hanging Option

Ball End Cable  
Stainless Steel  
Available lengths:  
48", 60", 72", 96", 120"



Stainless Steel

SKU: SSC101-\*\*



Stainless Steel

SKU: SSC100-\*\*



Clear Nylon

SKU: NC100-\*\*

#### Hook Option

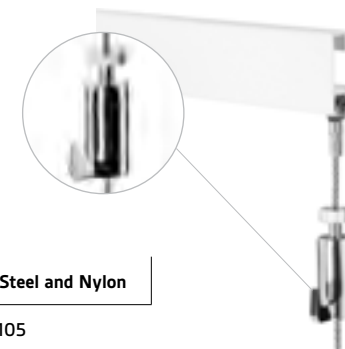

Hooks for Stainless Steel and Nylon

SKU: H105

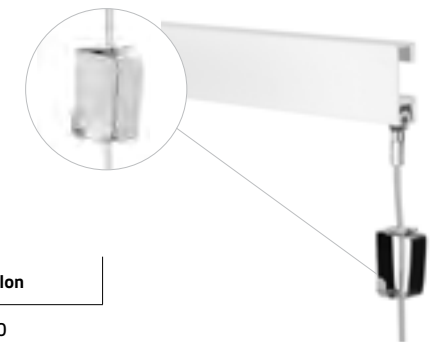

Hooks for Nylon

SKU: SH100

# Easy Rail

## Wall-Mounted



Rail	SKU
Silver Satin Anodized	AT100-A
Black Satin Anodized	AT100-B
White Painted	AT100-W
180 Colors Finishes*	AT100-C*
Natural Milled**	AT100-MF**
Easy Rail System Locator Kit (Drywall)	CTL150
Easy Rail System Locator Kit (Concrete)	CTL160

\* RAL standard colors with fee  
 \*\* Can have manufacturing scratches

### Choose Your Finish



Easy Rail System Locator  
 CTL100 (circle)  
 CTC100 (rectangle)

### Assembly instructions



1. Mark your installation location and install 6 Locators, each 12 inches apart. If you use multiple rails end-to-end, use a Connector to install them flush.

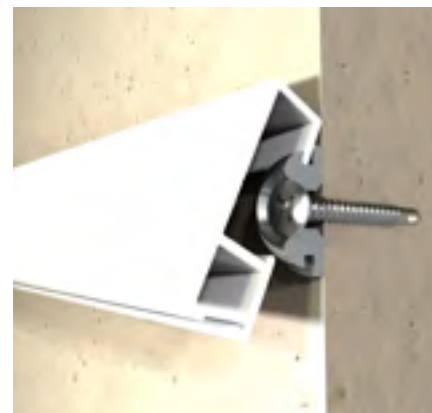

2. After your hardware is installed on the wall, line up the top of the rail with the top of the Locators, then push the bottom down until it eases into place.

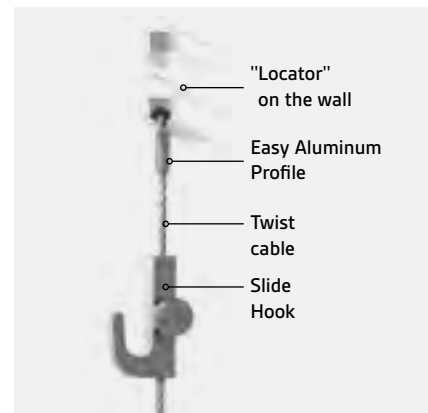

3. Finally, attach your cable to the rail and your hook to the cable and you have a beautiful picture hanging system ready to go!

# Easy Rail

## Wall-Cable and Hooks

### Cross Compatible with

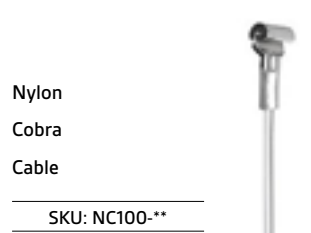
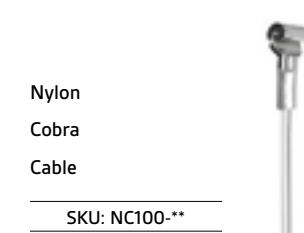
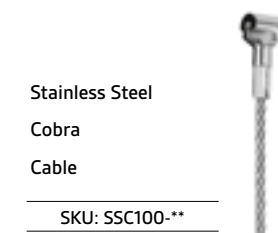



## Classic Rail

### Wall-Mounted



The Classic Rail picture hanging system is compatible with a wide variety of our hangers and hooks that make both horizontal and vertical adjustments easy, effortless and without damage to walls. Nails and unwanted holes will be a thing of the past when using Easy Rail.

#### Installation

Classic Rail, Picture Hanging System mounts to the wall with the use of (8) No. 6 Screws and Anchors. We recommend SKU: 2208 with ANC1 for Concrete or ANC5 for drywall.

- To hang items using the Classic Rail, you must select your hanger preference
  - Rod "P" or Cable "P" hook cable or "J" hook cable
- After you have selected your hanger option you must then select your hook preference
  - Cable Hook for Stainless Steel and Nylon Cable
  - Spring Hook for Nylon Cable
  - Safe hook for rod

#### Hanger Compatibility

- Cable "P" hook
- Stainless Steel - 26lbs
- Nylon - 26lbs

Application: Wall-Mounted

Material: Aluminum

Available Length: 72"

Rail Height: 1"

Available Colors: Silver Satin Anodized, Black

Satin Anodized, White Painted & 180 Colors

Powder Coated \* special order

Rated Rail Weight: 300 lb / 136 kg

(When Properly Installed)

\* This rail comes with 8 Pre-drilled holes.



## Classic Rail

### Wall-Mounted, Cable, Rod and Hooks

#### Finishes



SKU: AT101-A



SKU: AT101-B



SKU: AT101-W

Rail	SKU
Silver Satin Anodized	AT101-A
Black Satin Anodized	AT101-B
White Painted	AT101-W
180 Colors Finishes*	AT101-C*
Natural Milled**	AT101-MF**

\* RAL standard colors with fee  
\*\* Can have manufacturing scratches

Classic Rails are Picture Hanging Systems that are optimized for galleries, museums, etc. In order to put your system together you will need to choose your finish options, then your hanger options and finally your hook style. Once you have the core of your system selected, you can select the installation hardware.

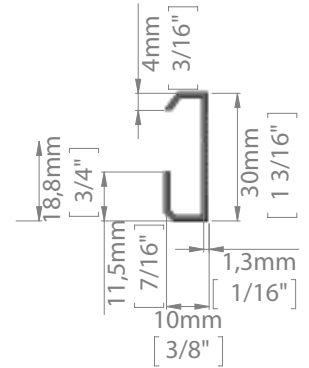

#### Hanging Option

"P" Hook Rod  
Available lengths:  
24", 48", 72"



SKU: CR100P\*\*

"J"  
Nylon Cable



SKU: NC103\*\*

"P" Hook cable  
Stainless Steel Available lengths:  
48", 72", 96", 120"

SKU: SSC104\*\*

Nylon Available lengths:  
48", 72", 96", 120"

SKU: NC104\*\*



Hooks for  
Stainless Steel  
and Nylon Cable



SKU: H105

Hook for  
Rod



SKU: SHR100

Hooks for  
Nylon Cable

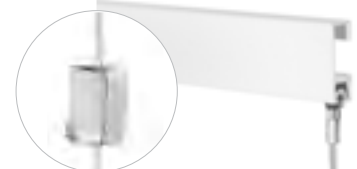

SKU: SH100

# Classic Rail

## Wall-Mounted



Rail	SKU
Silver Satin Anodized	AT101-A
Black Satin Anodized	AT101-B
White Painted	AT101-W
180 Colors Finishes*	AT101-C
Natural Milled**	AT101-MF

\* RAL standard colors with fee  
 \*\* Can have manufacturing scratches

### Choose Your Finish



Aluminum Clear  
 SKU: AT101-A



Aluminum Black  
 SKU: AT101-B



Aluminum White Painted  
 SKU: AT101-W



# Classic Rail

## Cable Rod and Hooks

### Cross Compatible with

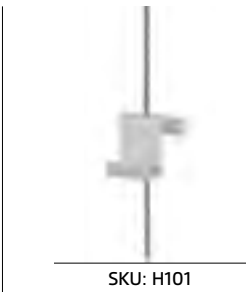
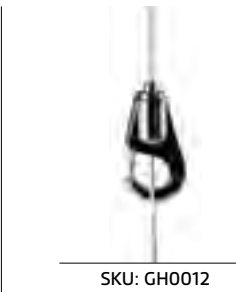
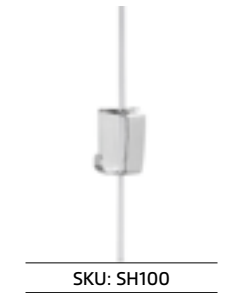
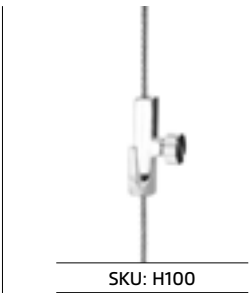
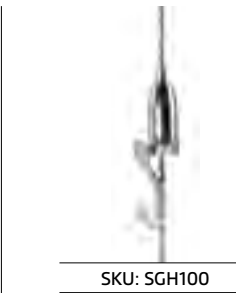
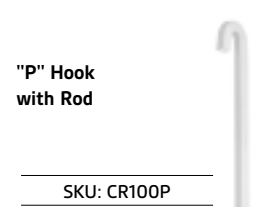
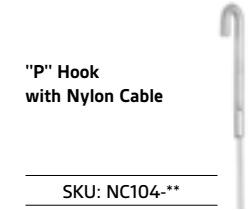
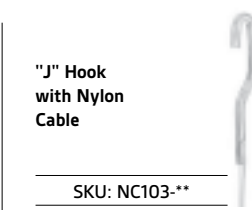
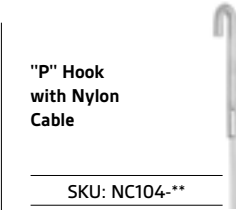
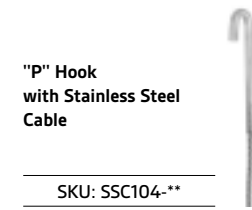



## Ceiling Rail

### Ceiling Mount



\* This rail comes with 8 Pre-drilled holes.

Application: Ceiling-Mounted

Material: Aluminum

Available Length: (72")

Rail Height: (1")

Available Colors: Silver Satin Anodized, Black

Satin Anodized, White Painted & 180 Colors

Powder Coated Special order

Rated Rail Weight: 50 lb / 68 kg

(When Properly Installed)



The Ceiling Rail picture hanging system is compatible with a wide variety of our hangers and hooks that make adjusting both horizontally and vertically easy, effortless and without damage to walls. Nails and unwanted holes will be a thing of the past when using Ceiling Rail.

### Installation

Ceiling Rails, Picture Hanging Systems mounts to the wall with the use of (8) 6 Screws and Anchors. We recommend SKU: 2208 with ANC1 for Concrete or ANCS for drywall.

- To hang items using the Ceiling Rail, you must select your hanger preference.
  - Cable "P"
  - Cable "J"
  - Rod "P"
- After you have selected your hanger option you must then select your hook preference
  - Cable Hook for Stainless Steel and Nylon Cable
  - Spring Hook for Nylon Cable
  - Safe hook for Rod



## Ceiling Rail

### Cable, Rod and Hooks

#### Finishes



Aluminum Clear  
SKU: AT102-A



Aluminum Black  
SKU: AT102-B



Aluminum White Painted  
SKU: AT102-W

Rail	SKU
Silver Satin Anodized	AT102-A
Black Satin Anodized	AT102-B
White Painted	AT102-W
180 Colors Finishes*	AT102-C
Natural Milled**	AT102-MF

\* RAL standard colors with fee  
\*\* Can have manufacturing scratches

Ceiling Rails are Picture Hanging Systems that are optimized for home or office usage. In order to put your system together you will need to choose your finish hanger, then your hanging options and finally your hook options. Once you have the core of your system selected, you can select the installation hardware.

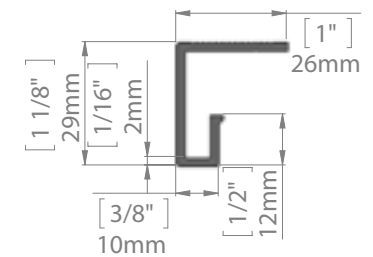

#### Hanging Option

"P"  
Hook Rod

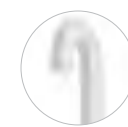

SKU: CR100P

"J"  
Nylon Cable



SKU: NC103\*\*

"P"  
Hook Cable  
Available in  
Stainless Steel  
and Nylon



SKU: SSC104\*\*



SKU: NC104\*\*

#### Hook Option

Hooks for  
Stainless Steel and  
Nylon Cable



SKU: H105

#### Hook for Rod



SKU: SHR100

#### Hooks for Nylon Cable



SKU: SH100

## Ceiling Rail

### Cable Mount



Mount	SKU
Silver Satin Anodized	AT102-A
Black Satin Anodized	AT102-B
White Painted	AT102-W
180 Colors Finishes*	AT102-C
Natural Mill**	AT102-MF

\* RAL standard colors with fee  
 \*\* Can have manufacturing scratches

### Choose Your Finish



Aluminum  
Clear  
SKU: AT102-A



Aluminum  
Black  
SKU: AT102-B



Aluminum  
White Painted  
SKU: AT102-W



## Ceiling Rail





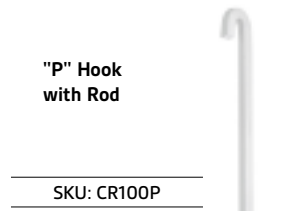
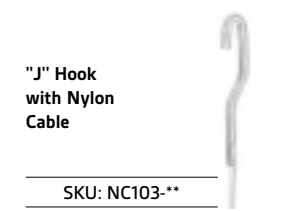
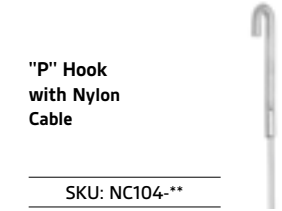
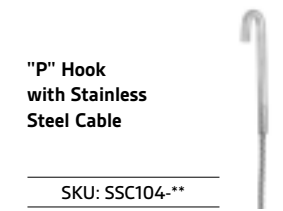

### Cable and Hooks

#### Cross Compatible with





## Hanging Cables

	Ball End	Length	SKU
	Stainless Steel Diameter: 1/16" Rated Strength: 45 Lbs (20 Kg) For: Easy Rail	48"	SSC101-48
		60"	SSC101-60
		72"	SSC101-72
		96"	SSC101-96
		120"	SSC101-120
	Stainless Steel Diameter: 1/16" Rated Strength: 45 Lbs (20 Kg) For: Easy Rail	48"	SSC100-48
		72"	SSC100-72
		96"	SSC100-96
		120"	SSC100-120
	Stainless Steel Diameter: 1/16" Rated Strength: 15 Lbs (6 Kg) For: Easy Rail	48"	NC100-48
		72"	NC100-72
		96"	NC100-96
		120"	NC100-120
	Nylon Cable Diameter: 1/16" Rated Strength: 45 Lbs (20 Kg) For: Classic Rail, Ceiling Rail	48"	NC103-48
		72"	NC103-72
		96"	NC103-96
		120"	NC103-120
	Stainless Steel Diameter: 1/16" Rated Strength: 15 Lbs (20 Kg) For: Classic Rail, Ceiling Rail	48"	SSC104-48
		72"	SSC104-72
		96"	SSC104-96
		120"	SSC104-120
	Nylon Diameter: 1/16" Rated Strength: 15 Lbs (6 Kg) For: Classic Rail, Ceiling Rail	48"	NC104-48
		72"	NC104-72
		96"	NC104-96
		120"	NC104-120

### "P" Aluminum

Square: 3/16" | Rated Strength 70 Lbs (31kg) | For: Classic Rail, Ceiling Rail

Length	Aluminum Clear (A)	Aluminum Black (B)	Aluminum White (W)	Aluminum Natural Finish (MF)	180 Color Finishes*
24"	CR100P-24A	CR100P-24B	CR100P-24W	CR100P-24MF	CR100P-24C*
48"	CR100P-48A	CR100P-48B	CR100P-48W	CR100P-48MF	CR100P-48C*
72"	CR100P-72A	CR100P-72B	CR100P-72W	CR100P-72MF	CR100P-72C*
96"	CR100P-96A	CR100P-96B	CR100P-96W	CR100P-96MF	CR100P-96C*

\* Hand Packing Fee applied

## Hooks for Stainless Steel and Nylon Cable

### Crane Hook with Side Screw

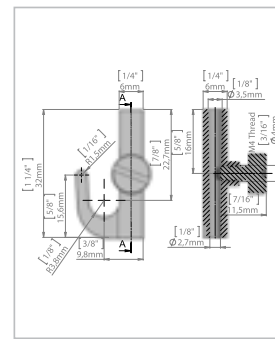

### L-Hook with Side Screw

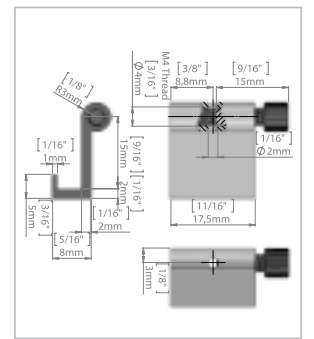

### Self-Gripping Captain's Hook

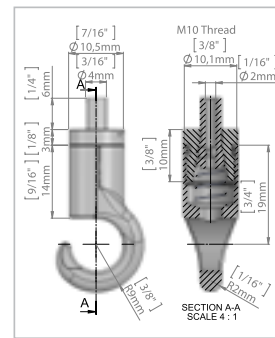

### Self-Gripping Low-Profile Hook

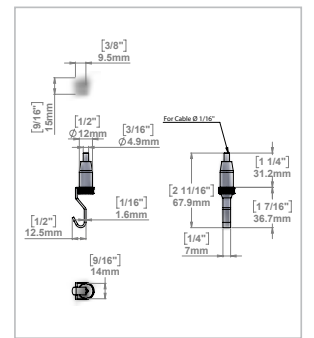

### Self-Gripping Anchor Hook

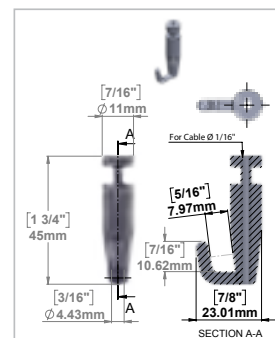

### Self-Gripping Barrel Hook

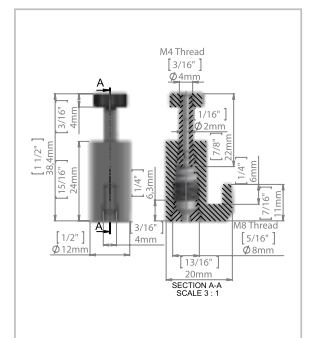

Finish	Use	Diameter	Strength	Use	SKU
Nickel	Ball End, Cobra Cable, "P" Hook Cable	3/64" to 1/16"	15 lbs (6 kg)	Easy Rail, Classic Rail, Ceiling Rail	H100NK
Aluminum	Ball End, Cobra Cable, "P" Hook Cable	3/64" to 1/16"	15 lbs (6 kg)	Easy Rail, Classic Rail, Ceiling Rail	H101NK
Nickel	Ball End, Cobra Cable, "P" Hook Cable	3/64" to 1/16"	15 lbs (6 kg)	Easy Rail, Classic Rail, Ceiling Rail	H103NK
Nickel	Ball End, Cobra Cable, "P" Hook Cable	3/64" to 1/16"	15 lbs (6 kg)	Easy Rail, Classic Rail, Ceiling Rail	H104NK
Nickel	Ball End, Cobra Cable, "P" Hook Cable	3/64" to 1/16"	15 lbs (6 kg)	Easy Rail, Classic Rail, Ceiling Rail	H105NK
Nickel	Ball End, Cobra Cable, "P" Hook Cable	3/64" to 1/16"	15 lbs (6 kg)	Easy Rail, Classic Rail, Ceiling Rail	SGH100

## Hooks for Stainless Steel and Nylon Cable

### Self-Gripping Hook with Safety Lock

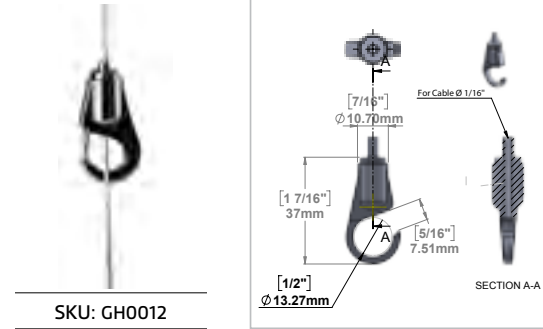

### Self-Gripping Hook

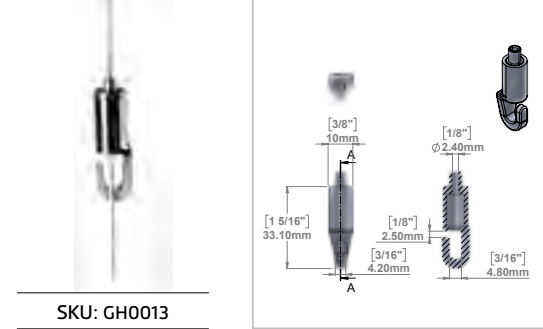

### Self-Gripping Hook with Safety Lock

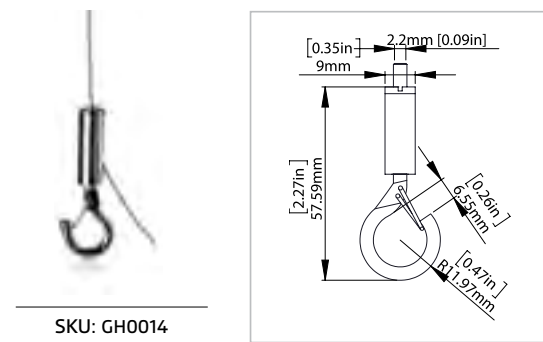

### Self-Gripping Cable Hook with Safety Lock

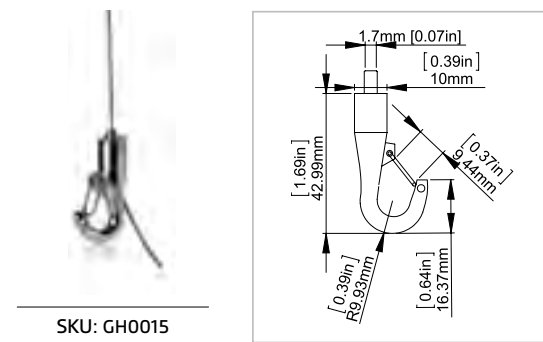

### Smart Spring

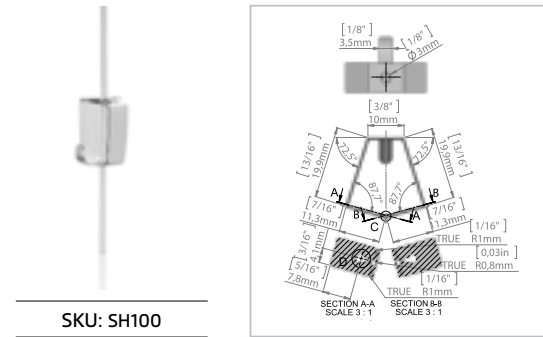

### Safe Hook for Rod

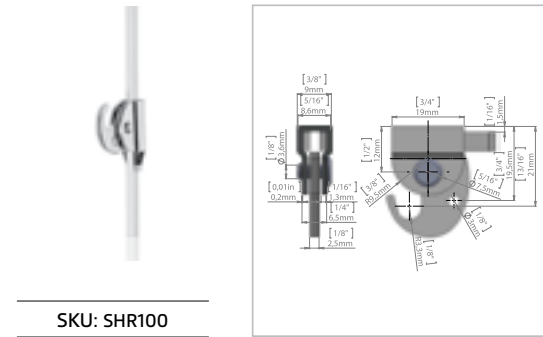

Finish	Use	Diameter	Strength	Use	SKU
Nickel	Ball End, Cobra Cable, "P" Hook Cable	3/64" to 1/16"	15 lbs (6 kg)	Easy Rail, Classic Rail, Ceiling Rail	GH0012
Nickel	Ball End, Cobra Cable, "P" Hook Cable	3/64" to 1/16"	15 lbs (6 kg)	Easy Rail, Classic Rail, Ceiling Rail	GH0013
Nickel	Ball End, Cobra Cable, "P" Hook Cable	3/64" to 1/16"	15 lbs (6 kg)	Easy Rail, Classic Rail, Ceiling Rail	GH0014
Nickel	Ball End, Cobra Cable, "P" Hook Cable	3/64" to 1/16"	15 lbs (6 kg)	Easy Rail, Classic Rail, Ceiling Rail	GH0015
Chrome	Ball End, Cobra Cable, "P" Hook Cable	3/8"	15 lbs (6 kg)	Easy Rail, Classic Rail, Ceiling Rail	SH100
Chrome	Smart Spring for Nylon Cable, "P" Rod	3/16"	15 lbs (6 kg)	Classic Rail or Ceiling Rail	SHR100

## Aircraft Wire Cable Stop Clamp Adjuster Gripper Loopers

Introducing a self-locking cable stop designed to diminish reliance on crimps and swaging tools for users. This innovative device offers ease of installation and adjustment through keyless push/pull buttons.



Finish	Use	Diameter	Strength	Use	SKU
Clear Aluminum	Ball End, Cobra Cable, "P" Hook Cable	3/64" to 1/16"	48 lbs (21.7 kg)	Easy Rail, Classic Rail, Ceiling Rail	DG005
Matte Black Aluminum	Ball End, Cobra Cable, "P" Hook Cable	3/64" to 1/16"	48 lbs (21.7 kg)	Easy Rail, Classic Rail, Ceiling Rail	DG005MB
Nickel Aluminum	Ball End, Cobra Cable, "P" Hook Cable	3/64" to 1/16"	48 lbs (21.7 kg)	Easy Rail, Classic Rail, Ceiling Rail	DG006
Matte Black Aluminum	Ball End, Cobra Cable, "P" Hook Cable	3/64" to 1/16"	48 lbs (21.7 kg)	Easy Rail, Classic Rail, Ceiling Rail	DG006MB
Zinc Alloy	POP signs, navigation signs, aisle markers, and ductwork	3/64" to 3/32"	170 lbs (77kg)	N/A	DG007

### Looped Cables

#### Nylon



#### Stainless Steel



Diameter	Length	SKU	Diameter	Length	SKU
1/16"	48"	NHC-48	1/16"	48"	SHC-48
	72"	NHC-72		72"	SHC-72
	96"	NHC-96		96"	SHC-96
	120"	NHC-120		120"	SHC-120



## Hooks For Stainless Steel and Nylon Cable

### Screw Gripping

Brass  
 Finish: Nickel plating  
 For use with: Ball End, Cobra Cable, "P" Hook Cable  
 For cable diameter: 3/64" to 1/16"  
 Rated strength: 15 lbs (6 kg)  
 For: Classic Rail, Ceiling Rail

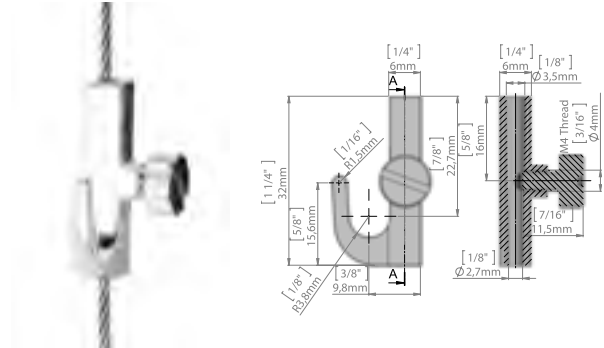

Nickel Plating      SKU: H100NK

### Screw Gripping

Aluminum  
 Finish: Nickel plating  
 For use with: Ball End, Cobra Cable, "P" Hook Cable  
 For cable diameter: 3/64" to 1/16"  
 Rated strength: 15 lbs (6 kg)  
 For: Classic Rail, Ceiling Rail

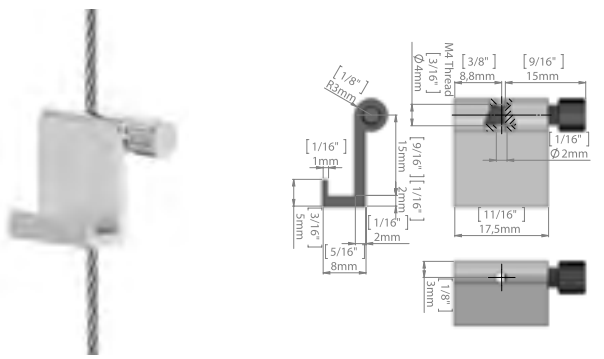

Nickel Plating      SKU: H101NK

### Looper for Nylon Cable

Locking Looper – Aluminum  
 Finish: Clear Anodized  
 For cable diameter: 1/16"  
 Rated strength: 15 lbs (6 kg)

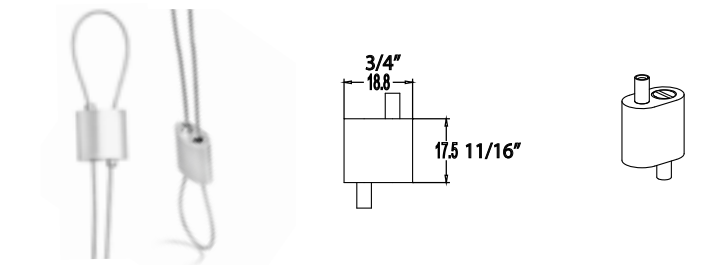

Aluminum Clear      SKU: DG005

### Cable Tensioner

Spring  
 Application: Cable tensioner

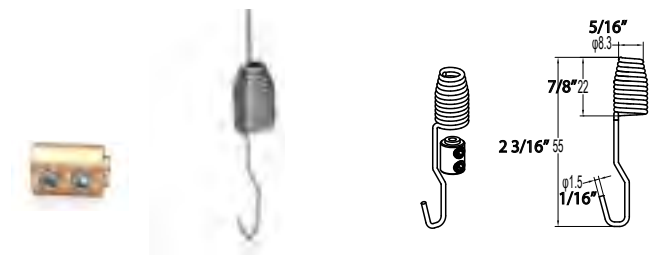

Brass      SKU: TSS100

## Hooks For Stainless Steel and Nylon Cable



Connector for Easy Rail  
 Finish: Raw Material  
 For use with: Easy Rail

SKU: CTC100



Picture Stabilizer  
 Size: 6-7/8"  
 Material: Steel  
 Finish: Nickel Plating

SKU: SPS100



Cable Cutter  
 Stainless Steel Cable Cutter, Signage, Aircraft, Bicycle Cable or Wire Rope, Up to 5/32"

SKU: CABLECUTTER



Easy Rail Hardware Package for Drywall  
 6 Easy Rail Locators, 6 Screws, and 6 Anchors for a Drywall Installation!

SKU: CTL150

### Drop Ceiling Hangers



T-Clamp  
 Material: Aluminum  
 SKU: TCLAMP



T-Clamp1  
 Material: Aluminum  
 SKU: TCLAMP1



T-Clamp2  
 Material: Plastic  
 SKU: TCLAMP2



Locator Aluminum  
 Finish: Nickel Plating  
 For use with: Easy Rail

SKU: CTL100



Picture Stabilizer  
 Size: 11-5/8"  
 Material: Steel  
 Finish: Nickel Plating

SKU: BPS100



Steel Swan Hook  
 The Swan Hook is designed to wedge behind crown molding for a clean, discreet look anywhere you want.

SKU: SH102



Easy Rail Hardware Package for Concrete  
 6 Easy Rail Locators, 6 Screws, and 6 Anchors for a Concrete Installation!

SKU: CTL160

## Aluminum Snap Frames

High-Quality Aluminum Construction

**Product** Snap Frames  
Silver or Black Color

**Unique Features** Indoor  
Wall mounted  
5 Different Dimensions  
2 Different Finishes

**Area Of Use** Signage  
Wayfinder  
Display  
Advertising



### Easy Open/Close Frame



Frame Size	Profile	Insert Size	Aluminum Clear	Aluminum Black
12.5" x 18.5"	1.25"	11" x 17"	ALSF001	ALSF002
19.5" x 25.5"	1.25"	18" x 24"	ALSF003	ALSF004
23.5" x 29.5"	1.25"	22" x 28"	ALSF005	ALSF006
23.5" x 29.5"	1.00"	22" x 28"	N/A	ALSF007
25.5" x 37.5"	1.25"	24" x 36"	ALSF008	ALSF009
28.5" x 41.5"	1.25"	27" x 40"	ALSF010	ALSF011
31.5" x 41.5"	1.25"	30" x 40"	ALSF012	ALSF013
37.5" x 49.5"	1.25"	36" x 48"	ALSF014	ALSF015
41.5" x 61.5"	1.25"	40" x 60"	ALSF016	ALSF017

## Hanging Banner Rails

Enjoy quick changing systems to change from one piece to another with ease



### Aluminum Rails with Locking Rollers

The Aluminum Display Rail is the perfect alternative to a typical bulletin. It eliminates the need for tacks and pins, which means it won't leave unsightly holes or damage your materials.

Length	SKU
8.5"	AAP85
11"	AAP11
18"	AAP18
22"	AAP22
24"	AAP24
27"	AAP27
30"	AAP30
48"	AAP48
72"	AAP72



### 2 Piece Aluminum Snap Rails with Spring Mechanism

Simply level your display rail and mark your holes. Next, install your anchors, line your display rail up, and screw it into place. Now you are ready to start hanging up your artwork! Just un-snap the rail, insert your material, then snap it back into place and VOILA!

Length	SKU
8.5"	ABR85
11"	ABR11
18"	ABR18
22"	ABR22
24"	ABR24
27"	ABR27
30"	ABR30
48"	ABR48
72"	ABR72



### Clear Plastic Snap Rail

Great for wide papers, posters and banners. Quick changing display and elegant design. Easy open/close and reusable system.

Length	SKU
8.5"	SCP85
11"	SCP11
18"	SCP18
22"	SCP22
24"	SCP24
27"	SCP27
30"	SCP30
36"	SCP36
48"	SCP48
72"	SCP72